

### ED Series



- AC output Solid State Relay in an Industry standard EMR plug in package
- Ratings of 3 & 5 Amps
- Load voltage range of 24-280VAC
- Fits standard DIN rail & PCB mountable sockets
- LED input status indicator
- AC or DC control
- cUL Recognized, IEC Rated, CE & RoHS Compliant
- Horsepower Rated, Pilot Duty Rated

### PRODUCT SELECTION

Description	3 A	5 A
3-15 VDC Control	ED24D3	ED24D5
18-32 VDC Control	ED24C3	ED24C5
48-72 VDC Control	ED24F3	ED24F5
18-36 VAC Control		ED24E5
90-140 VAC Control		ED24B5

### AVAILABLE OPTIONS

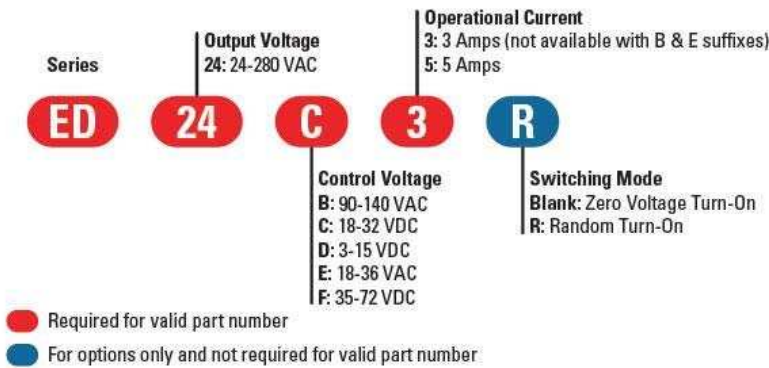

### OUTPUT SPECIFICATIONS AC Output (1)

Description	3 A	5 A
Operating Voltage (47-63Hz) [Vrms]	24-280	24-280
Transient Overvoltage [Vpk]	600	600
Maximum Resistive Load Current UL 508/ IEC 62314 LC-A [Arms, FLA] (2)	3	5
Minimum Load Current [Arms]	0.15	0.15
Maximum Off-State Leakage Current @ Rated Voltage [mArms]	0.1	0.1
Minimum Off-State dv/dt @ Maximum Rated Voltage [V/usec] (3)	500	500
Maximum On-State Voltage Drop @ Rated Current [Vpk]	1.1	1.1
Maximum Surge Current (50/60 Hz, 1 cycle) [Apk]	240/250	600/625
Maximum I <sup>2</sup> t for Fusing (50/60 HZ, 1/2 cycle) [A <sup>2</sup> sec]	285/260	1780/1620
UL 508 HP/IEC 62314 LC-B Rating @ 240V, 40°C [HP/KW]	0.25 / 0.37	0.5 / 0.55
Minimum Power Factor (with Maximum Load)	0.5	0.5

**INPUT SPECIFICATIONS (1)**

Description	ED24Dx	ED24Cx	ED24Fx	ED24Ex	ED24Bx
Control Voltage Range	3-15 VDC	18-32 VDC	48-72 VDC	18-36 VAC	90-140 VAC
Minimum Turn-On Voltage	3 VDC	18 VDC	48 VDC	18 VAC	90 VAC
Minimum Turn-Off Voltage	1.9 VDC	10.5 VDC	24 VDC	10 VAC	48 VAC
Maximum Reverse Voltage	6 VDC	6 VDC	6 VDC	N/A	N/A
Minimum Input Current [mA]	3.8	3.8	3.8	3.8	3.2
Maximum Input Current [mA]	33.8	6.9	5.8	8.5	4.9
Nominal Input Impedance [ohms]	500	4.8K	12.5K	4.5K	28K
Maximum Turn-On Time [msec] (4)	8.33	8.33	8.33	20	20
Maximum Turn-Off Time [msec]	8.33	8.33	8.33	30	30

**GENERAL SPECIFICATIONS (1)**

Description	Parameters
Dielectric Strength, Input/Output (50/60Hz)	3750 Vrms
Minimum Insulation Resistance (@ 500 V DC)	10 <sup>9</sup> Ohms
Maximum Capacitance, Input/Output	10 pF
Ambient Operating Temperature Range	-30°C to 80°C
Ambient Storage Temperature Range	-40°C to 125°C
Weight (typical)	1.06 oz. (30 g)
Maximum Humidity	85% non-condensing
Housing Material	Polyamide Class V0 (UL94)
Terminals Material	Copper w/Sulfamet Nickel finish

**GENERAL NOTES**

- 1) All parameters at 25°C un less otherwise specified.
- 2) Based on 17mm (5A model) and 13mm (3A model) spacing minimum between parts.
- 3) Off-State dv/dt test method per EIA/NARM standard RS-443, paragraph 13.11.1
- 4) Turn-On time for Random turn-on versions is 0.1ms for DC control and 5ms for AC control.

**MECHANICAL SPECIFICATIONS**

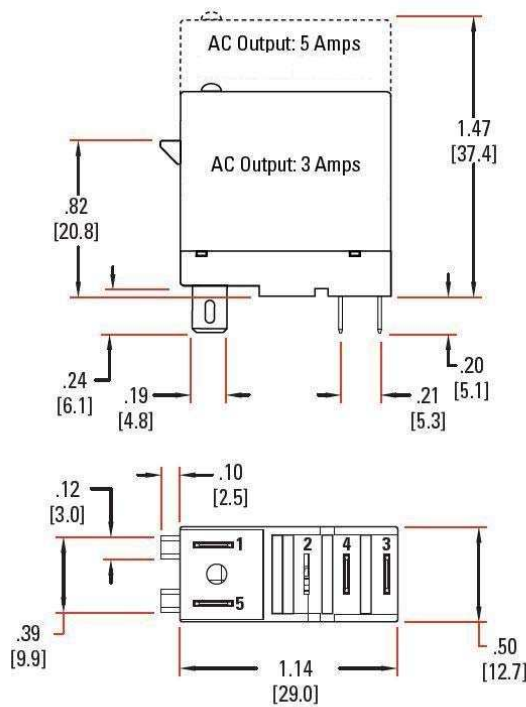
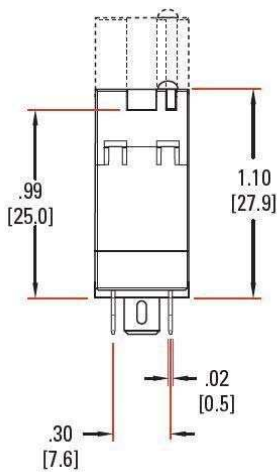

Tolerances: ±0.02 in / 0.5 mm  
All dimensions are in: inches [millimeters]

### WIRING DIAGRAM

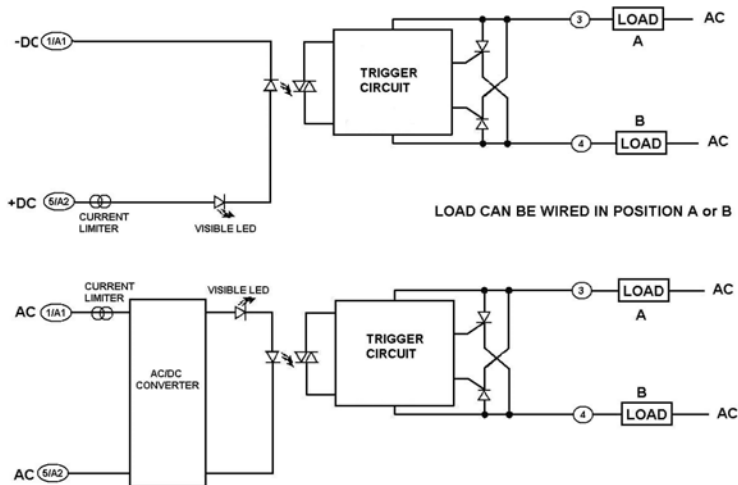

### THERMAL DERATE INFORMATION

#### AMBIENT TEMPERATURE DERATING CURVE

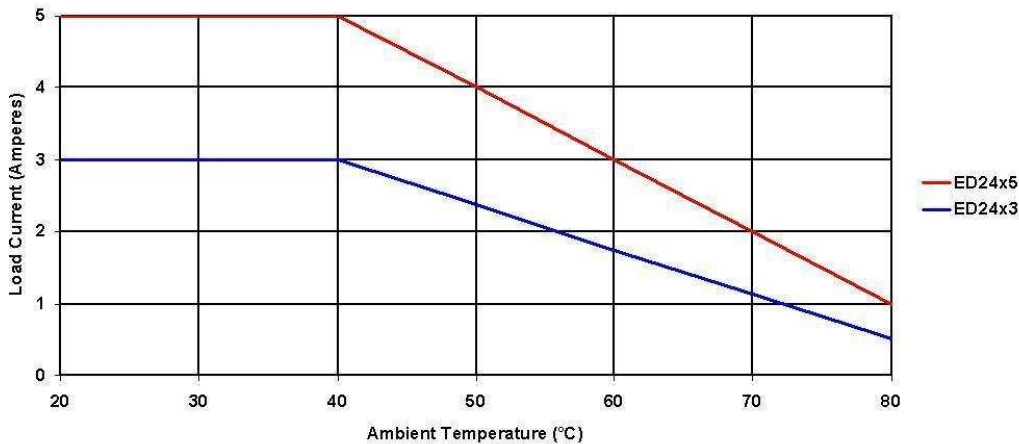

Above curve is based on a minimum spacing between parts of 17mm for ED24x5 and 13mm for ED24x3. Maximum current @ 0mm spacing is 2.7A for ED24x5 and 2.3A for ED24x3 @ 40°C.

Derating Value: ED24x5 = 0.135A per mm  
ED24x3 = 0.054A per mm

Derating based on Relay air gap:

Example: 10mm spacing with a ED24D5 SSR

1. Subtract spacing from the minimum required spacing of the part (17mm) to get the correction value.  
 $17 - 10 = 7$
2. Multiply air gap derating value found above with correction value.  
 $0.135 \times 7 = 0.945A$

Now using this final number we can figure out what the maximum current the relay can carry with 10mm spacing @ 60°C Ambient.

3. Using the Ambient Derating Curve above find the current for the 5A model @ 60°C. In this case that value is 3A.
4. Subtract the value above (0.945A) from 3A.  
 $3 - 0.945 = 2.055A$

The maximum current you can switch with the ED24D5 with a 10mm air gap between relays @ 60°C ambient is 2.055A

### AGENCY APPROVALS

Designed in accordance with the requirements of IEC 62314  
Pilot Duty Rated C300  
IEC 61000-4-2 : Electrostatic Discharge Level 3 – Criteria A  
IEC 61000-4-4 : Electrically Fast Transients Level 3 – Criteria B  
IEC 61000-4-5 : Electrical Surges Level 3 – Criteria A

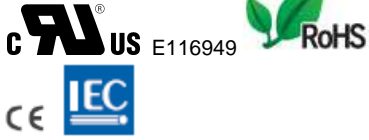

Rev 031312

### ACCESSORIES

#### ED Series Accessories

##### DRSED



##### **DIN Rail Mountable Socket**

Part no.: DRSED  
Fingersafe IP10 DIN rail mountable socket to mount ED series relays onto standard 35 mm DIN rail. Rated at 250 V AC/DC, 12 Amps. The DRSED includes M3 Combo screws.

##### PCBSED



##### **PC Board Mountable Socket**

Part no.: PCBSED  
PC Board mountable socket for ED series relays. Rated at 250 V AC/DC, 12 Amps. Suggested Pin-out hole diameter: 1.0 mm

 <b>DANGER / PELIGRO / DANGER /GEFAHR / PERICOLO / PERIGO</b>					
<p><b>HAZARD OF ELECTRIC SHOCK, EXPLOSION, OR ARC FLASH.</b></p> <ul style="list-style-type: none"> <li>• Disconnect all power before installing or working with this equipment.</li> <li>• Verify all connections and replace all covers before turning on power.</li> </ul> <p><b>Failure to follow these instructions will result in death or serious injury.</b></p>	<p><b>RIESGO DE DESCARGA ELECTRICA O EXPLOSION.</b></p> <ul style="list-style-type: none"> <li>• Desconectar todos los suministros de energia a este equipo antes de trabajar con este equipo.</li> <li>• Verificar todas las conexiones y colocar todas las tapas antes de energizar el equipo.</li> </ul> <p><b>El incumplimiento de estas instrucciones puede provocar la muerte o lesiones serias.</b></p>	<p><b>RISQUE DE DESCARGE ELECTRIQUE OU EXPLOSION</b></p> <ul style="list-style-type: none"> <li>• Eteindre toutes les sources d'énergie de cet appareil avant de travailler dessus de cet appareil</li> <li>• Vérifier tous connections, et remettre tous couverts en olace avant de mettre sous</li> </ul> <p><b>De non-suivi de ces instructions provoquera la mort ou des lésions sérieuses sérieuses.</b></p>	<p><b>GEFAHR EINES ELEKTRISCHE N SCHLAGES ODER EINER EXPLOSION.</b></p> <ul style="list-style-type: none"> <li>• Stellen Sie jeglichen Strom ab, der dieses Gerät versorgt, bevor Sie an dem Gerät Arbeiten durchführen</li> <li>• Vor der Inbetriebnahme alle Anschlüsse überprüfen und alle Gehäuseteile montieren.</li> </ul> <p><b>Unterlassung dieser Anweisungen können zum Tode oder zu schweren Verletzungen führen.</b></p>	<p><b>RISCHIO DI SCOSSA ELETTRICA O DELL'ESPLOSIONE.</b></p> <ul style="list-style-type: none"> <li>• Spenga tutta l'alimentazion e che fornisce questa apparecchiatura prima del lavorare a questa apparecchiatura</li> <li>• Verificare tutti i collegamenti e sostituire tutte le coperture prima della rotazione sull'alimentazione</li> </ul> <p><b>L'omissione di seguire queste istruzioni provocherà la morte o di lesioni serie</b></p>	<p><b>RISCO DE DESCARGA ELÉTRICA OU EXPLOÇÃO</b></p> <ul style="list-style-type: none"> <li>• Desconectar o equipamento de toda a energia antes de instalar ou trabalhar com este equipamento</li> <li>• Verificar todas as conexões e recolocar todas as tampas antes de religar o equipamento</li> </ul> <p><b>O não cumprimento destas instruções pode levar à morte ou lesões sérias.</b></p>

 <b>WARNING / AVERTISSEMENT / WARNUNG /ADVERTENCIA / AVVERTENZA / AVISO</b>		
<p><b>RISK OF MATERIAL DAMAGE AND HOT ENCLOSURE</b></p> <ul style="list-style-type: none"> <li>• The product's side panels may be hot, allow the product to cool before touching.</li> <li>• Follow proper mounting instructions including torque values.</li> <li>• Do not allow liquids or foreign objects to enter this product.</li> </ul> <p><b>Failure to follow these instructions can result in serious injury, or equipment damage.</b></p>	<p><b>RISQUE DE DOMMAGE MATERIEL ET DE SURCHAUFFE DU BOITIER</b></p> <ul style="list-style-type: none"> <li>• Les panneaux latéraux du produit peuvent être chauds. Laissez le produit refroidir avant de le toucher.</li> <li>• Respecter les consignes de montage, et notamment les couples de serrage.</li> <li>• Ne pas laisser pénétrer de liquide ni de corps étrangers à l'intérieur du produit.</li> </ul> <p><b>Le non-respect de cette directive peut entraîner, des lésions corporelles graves ou des dommages matériels.</b></p>	<p><b>GEFAHR VON MATERIALSCHÄDEN UND GEHÄUSEERHITZUNG</b></p> <ul style="list-style-type: none"> <li>• Die Seitenwände können heiß sein. Lassen Sie das Produkt abkühlen, bevor Sie es berühren.</li> <li>• Beachten Sie die Montageanweisungen,</li> <li>• Führen Sie keine Flüssigkeiten oder Fremdkörper in das Produkt ein.</li> </ul> <p><b>Die Nichtbeachtung dieser Anweisung kann Körperverletzung oder Materialschäden zur Folge haben.</b></p>
<p><b>RIESGO DE DAÑOS MATERIALES Y DE SOBRECIENTAMIENTO DE LA UNIDAD</b></p> <ul style="list-style-type: none"> <li>• Los paneles laterales del producto pueden estar calientes. Esperar que el producto se enfríe antes de tocarlo.</li> <li>• Respetar las instrucciones de montaje, y en particular los pares de apretado.</li> <li>• No dejar que penetren líquidos o cuerpos extraños en el producto.</li> </ul> <p><b>Si no se respetan estas precauciones pueden producirse graves lesiones, daños materiales.</b></p>	<p><b>RISCHIO DI DANNI MATERIALI E D'INVOLUCRO CALDO</b></p> <ul style="list-style-type: none"> <li>• I pannelli laterali dell'apparecchio possono scottare; lasciar quindi raffreddare il prodotto prima di toccarlo.</li> <li>• Seguire le istruzioni di montaggio corrette.</li> <li>• Non far entrare liquidi o oggetti estranei in questo apparecchio.</li> </ul> <p><b>La mancata osservanza di questa precauzione può causare gravi rischi per l'incolumità personale o danni alle apparecchiature.</b></p>	<p><b>RISCO DE DANO MATERIAL E DE AQUECIMENTO</b></p> <ul style="list-style-type: none"> <li>• Os painéis laterais do produto podem estar quentes; dê tempo ao produto para arrefecer antes de lhe tocar.</li> <li>• Siga devidamente as instruções de montagem.</li> <li>• Não permita a entrada de líquidos e de objectos estranhos no produto.</li> </ul> <p><b>A não observância destas precauções pode provocar a morte, ferimentos graves ou danos materiais.</b></p>

The environmental information disclosed in this annex including the EIP Pollution logo are in compliance with People's Republic of China Electronic Industry Standard SJ/T11364 – 2006, Marking for Control of Pollution Caused by Electronic Information Products.

Part Name	Toxic or hazardous Substance and Elements					
	Lead (Pb)	Mercury (Hg)	Cadmium (Cd)	Hexavalent Chromium (Cr (VI))	Polybrominated biphenyls (PBB)	Polybrominated diphenyl ethers (PBDE)
Semiconductor die	X	0	0	0	0	0
Solder	X	0	0	0	0	0

此附件所标示的包括电子信息产品污染图标的环保信息符合中华人民共和国电子行业标准 **SJ/T11364 - 2006**, 电子信息产品污染控制标识要求



部件名称	有毒有害物质或元素					
	铅 (Pb)	汞 (Hg)	镉 (Cd)	六价铬 (Cr (VI))	多溴联苯 (PBB)	多溴二苯醚 (PBDE)
半导体芯片	X	0	0	0	0	0
焊接点	X	0	0	0	0	0