

TOSHIBA Bipolar Linear Integrated Circuit Silicon Monolithic

# TAR5S15U~TAR5S50U

## Point Regulators (Low-Dropout Regulators)

The TAR5SxxU Series consists of general-purpose bipolar LDO regulators with an on/off control pin and features overtemperature and overcurrent protection circuits.

### Features

- Low standby current
- Overtemperature and overcurrent protections
- Wide operating voltage range
- High maximum output current
- Low input-to-output voltage differential
- Small package (UFV package similar to SOT-353)
- Allows use of ceramic capacitors as the input and output capacitors.

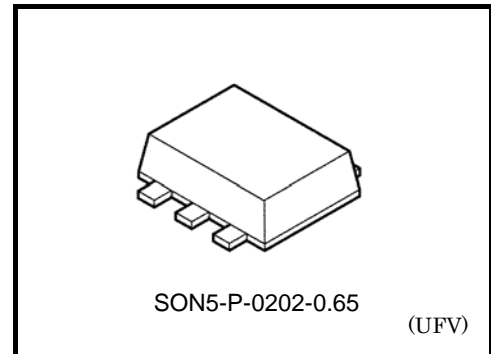

Weight: 0.007 g (typ.)

### Pin Assignment (Top View)

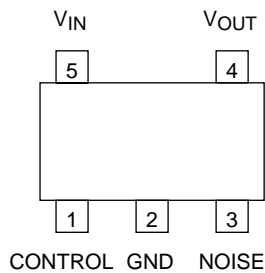

The overtemperature and overcurrent protection features are not intended to guarantee correct operation below the absolute maximum ratings.

Do not use the TAR5SxxU under conditions where the absolute maximum ratings may be exceeded.

## List of Part Numbers and Markings

Part No.	Marking	Part No.	Marking
TAR5S15U	1V5	TAR5S33U	3V3
TAR5S16U	1V6	TAR5S34U	3V4
TAR5S17U	1V7	TAR5S35U	3V5
TAR5S18U	1V8	TAR5S36U	3V6
TAR5S19U	1V9	TAR5S37U	3V7
TAR5S20U	2V0	TAR5S38U	3V8
TAR5S21U	2V1	TAR5S39U	3V9
TAR5S22U	2V2	TAR5S40U	4V0
TAR5S23U	2V3	TAR5S41U	4V1
TAR5S24U	2V4	TAR5S42U	4V2
TAR5S25U	2V5	TAR5S43U	4V3
TAR5S26U	2V6	TAR5S44U	4V4
TAR5S27U	2V7	TAR5S45U	4V5
TAR5S28U	2V8	TAR5S46U	4V6
TAR5S29U	2V9	TAR5S47U	4V7
TAR5S30U	3V0	TAR5S48U	4V8
TAR5S31U	3V1	TAR5S49U	4V9
TAR5S32U	3V2	TAR5S50U	5V0

## Part Marking

Example: TAR5S30U (3.0-V output)

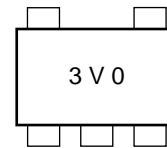

## Absolute Maximum Ratings (Ta = 25°C)

Characteristics	Symbol	Rating	Unit
Supply Voltage	$V_{IN}$	15	V
Output Current	$I_{OUT}$	200	mA
Power Dissipation	$P_D$	450 (Note 1)	mW
Operation Temp. Range	$T_{opr}$	-40 to 85	°C
Storage Temp. Range	$T_{stg}$	-55 to 150	°C

Note: Using continuously under heavy loads (e.g. the application of high temperature/current/voltage and the significant change in temperature, etc.) may cause this product to decrease in the reliability significantly even if the operating conditions (i.e. operating temperature/current/voltage, etc.) are within the absolute maximum ratings and the operating ranges.

Please design the appropriate reliability upon reviewing the Toshiba Semiconductor Reliability Handbook ("Handling Precautions"/"Derating Concept and Methods") and individual reliability data (i.e. reliability test report and estimated failure rate, etc).

Note 1: Mounted on a glass epoxy circuit board of 30 mm × 30 mm; Pad dimension of 35 mm<sup>2</sup>

## TAR5S15U~TAR5S22U

**Electrical Characteristic (unless otherwise specified,  $V_{IN} = V_{OUT} + 1$  V,  $I_{OUT} = 50$  mA,  $C_{IN} = 1$   $\mu$ F,  $C_{OUT} = 10$   $\mu$ F,  $C_{NOISE} = 0.01$   $\mu$ F,  $T_j = 25^\circ$ C)**

Characteristics	Symbol	Test Condition	Min	Typ.	Max	Unit
Output voltage	$V_{OUT}$	Please refer to the Output Voltage Accuracy table.				
Line regulation	Reg·line	$V_{OUT} + 1$ V $\leq V_{IN} \leq 15$ V, $I_{OUT} = 1$ mA	—	3	15	mV
Load regulation	Reg·load	$1$ mA $\leq I_{OUT} \leq 150$ mA	—	25	75	mV
Quiescent current	$I_{B1}$	$I_{OUT} = 0$ mA	—	170	—	$\mu$ A
	$I_{B2}$	$I_{OUT} = 50$ mA	—	550	850	
Standby current	$I_B$ (OFF)	$V_{CT} = 0$ V	—	—	0.1	$\mu$ A
Output noise voltage	$V_{NO}$	$V_{IN} = V_{OUT} + 1$ V, $I_{OUT} = 10$ mA, $10$ Hz $\leq f \leq 100$ kHz, $C_{NOISE} = 0.01$ $\mu$ F, $T_a = 25^\circ$ C	—	30	—	$\mu$ V <sub>rms</sub>
Temperature coefficient	$T_{CVO}$	$-40^\circ$ C $\leq T_{opr} \leq 85^\circ$ C	—	100	—	ppm/ $^\circ$ C
Input voltage	$V_{IN}$	—	2.4	—	15	V
Ripple rejection	R.R.	$V_{IN} = V_{OUT} + 1$ V, $I_{OUT} = 10$ mA, $C_{NOISE} = 0.01$ $\mu$ F, $f = 1$ kHz, $V_{Ripple} = 500$ mV <sub>p-p</sub> , $T_a = 25^\circ$ C	—	70	—	dB
Control voltage (ON)	$V_{CT}$ (ON)	—	1.5	—	$V_{IN}$	V
Control voltage (OFF)	$V_{CT}$ (OFF)	—	—	—	0.4	V
Control current (ON)	$I_{CT}$ (ON)	$V_{CT} = 1.5$ V	—	3	10	$\mu$ A
Control current (OFF)	$I_{CT}$ (OFF)	$V_{CT} = 0$ V	—	0	0.1	$\mu$ A

## TAR5S23U~TAR5S50U

**Electrical Characteristic (unless otherwise specified,  $V_{IN} = V_{OUT} + 1$  V,  $I_{OUT} = 50$  mA,  $C_{IN} = 1$   $\mu$ F,  $C_{OUT} = 10$   $\mu$ F,  $C_{NOISE} = 0.01$   $\mu$ F,  $T_j = 25^\circ$ C)**

Characteristics	Symbol	Test Condition	Min	Typ.	Max	Unit
Output voltage	$V_{OUT}$	Please refer to the Output Voltage Accuracy table.				
Line regulation	Reg·line	$V_{OUT} + 1$ V $\leq V_{IN} \leq 15$ V, $I_{OUT} = 1$ mA	—	3	15	mV
Load regulation	Reg·load	$1$ mA $\leq I_{OUT} \leq 150$ mA	—	25	75	mV
Quiescent current	$I_{B1}$	$I_{OUT} = 0$ mA	—	170	—	$\mu$ A
	$I_{B2}$	$I_{OUT} = 50$ mA	—	550	850	
Standby current	$I_B$ (OFF)	$V_{CT} = 0$ V	—	—	0.1	$\mu$ A
Output noise voltage	$V_{NO}$	$V_{IN} = V_{OUT} + 1$ V, $I_{OUT} = 10$ mA, $10$ Hz $\leq f \leq 100$ kHz, $C_{NOISE} = 0.01$ $\mu$ F, $T_a = 25^\circ$ C	—	30	—	$\mu$ V <sub>rms</sub>
Dropout volatge	$V_{IN} - V_{OUT}$	$I_{OUT} = 50$ mA	—	130	200	mV
Temperature coefficient	$T_{CVO}$	$-40^\circ$ C $\leq T_{opr} \leq 85^\circ$ C	—	100	—	ppm/ $^\circ$ C
Input voltage	$V_{IN}$	—	$V_{OUT} + 0.2$ V	—	15	V
Ripple rejection	R.R.	$V_{IN} = V_{OUT} + 1$ V, $I_{OUT} = 10$ mA, $C_{NOISE} = 0.01$ $\mu$ F, $f = 1$ kHz, $V_{Ripple} = 500$ mV <sub>p-p</sub> , $T_a = 25^\circ$ C	—	70	—	dB
Control voltage (ON)	$V_{CT}$ (ON)	—	1.5	—	$V_{IN}$	V
Control voltage (OFF)	$V_{CT}$ (OFF)	—	—	—	0.4	V
Control current (ON)	$I_{CT}$ (ON)	$V_{CT} = 1.5$ V	—	3	10	$\mu$ A
Control current (OFF)	$I_{CT}$ (OFF)	$V_{CT} = 0$ V	—	0	0.1	$\mu$ A

## Output Voltage Accuracy

( $V_{IN} = V_{OUT} + 1\text{ V}$ ,  $I_{OUT} = 50\text{ mA}$ ,  $C_{IN} = 1\text{ }\mu\text{F}$ ,  $C_{OUT} = 10\text{ }\mu\text{F}$ ,  $C_{NOISE} = 0.01\text{ }\mu\text{F}$ ,  $T_j = 25^\circ\text{C}$ )

Part No.	Symbol	Min	Typ.	Max	Unit
TAR5S15U	V <sub>OUT</sub>	1.44	1.5	1.56	V
TAR5S16U		1.54	1.6	1.66	
TAR5S17U		1.64	1.7	1.76	
TAR5S18U		1.74	1.8	1.86	
TAR5S19U		1.84	1.9	1.96	
TAR5S20U		1.94	2.0	2.06	
TAR5S21U		2.04	2.1	2.16	
TAR5S22U		2.14	2.2	2.26	
TAR5S23U		2.24	2.3	2.36	
TAR5S24U		2.34	2.4	2.46	
TAR5S25U		2.43	2.5	2.57	
TAR5S26U		2.53	2.6	2.67	
TAR5S27U		2.63	2.7	2.77	
TAR5S28U		2.73	2.8	2.87	
TAR5S29U		2.83	2.9	2.97	
TAR5S30U		2.92	3.0	3.08	
TAR5S31U		3.02	3.1	3.18	
TAR5S32U		3.12	3.2	3.28	
TAR5S33U		3.21	3.3	3.39	
TAR5S34U		3.31	3.4	3.49	
TAR5S35U		3.41	3.5	3.59	
TAR5S36U		3.51	3.6	3.69	
TAR5S37U		3.6	3.7	3.8	
TAR5S38U		3.7	3.8	3.9	
TAR5S39U		3.8	3.9	4.0	
TAR5S40U		3.9	4.0	4.1	
TAR5S41U		3.99	4.1	4.21	
TAR5S42U		4.09	4.2	4.31	
TAR5S43U		4.19	4.3	4.41	
TAR5S44U		4.29	4.4	4.51	
TAR5S45U	4.38	4.5	4.62		
TAR5S46U	4.48	4.6	4.72		
TAR5S47U	4.58	4.7	4.82		
TAR5S48U	4.68	4.8	4.92		
TAR5S49U	4.77	4.9	5.03		
TAR5S50U	4.87	5.0	5.13		

## Application Notes

### 1. Recommended Application Circuit

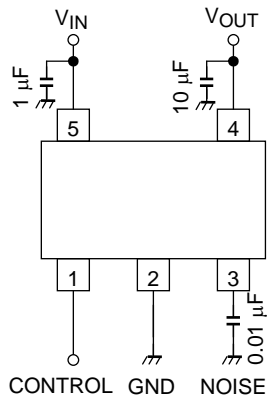

CONTROL	Operation
HIGH	ON
LOW	OFF

A noise-damping capacitor should be connected between the NOISE pin and GND for stable operation. The recommended value is higher than 0.0047  $\mu\text{F}$ .

The above figure shows the recommended application circuit for the TAR5SxxU. Capacitors should be connected to  $V_{\text{IN}}$  and  $V_{\text{OUT}}$  for input/output stabilization.

If on/off control is not required, it is recommended to connect the CONTROL pin (pin 1) to  $V_{\text{CC}}$ .

### 2. Power Dissipation

The power dissipation rating (450 mW) is measured on a board shown below. More power can be safely dissipated by reducing the input voltage, output current and/or ambient temperature. It is recommended to use the TAR5SxxU at 70% to 80% of the absolute maximum power dissipation.

### Thermal Resistance Evaluation Board

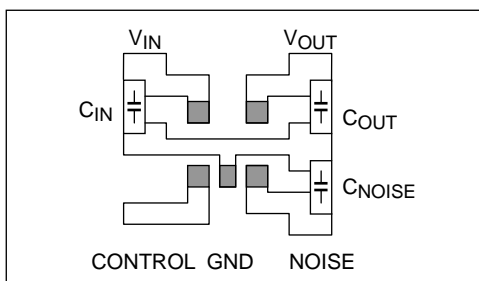

Material: Glass epoxy  
 Dimensions: 30 mm  $\times$  30 mm  
 Copper pad area: 35 mm<sup>2</sup>, t = 0.8 mm

**3. Ripple Rejection**

The TAR5SxxU feature a good power supply ripple rejection and input transient response, making them an ideal solution for the RF block of cell phones.

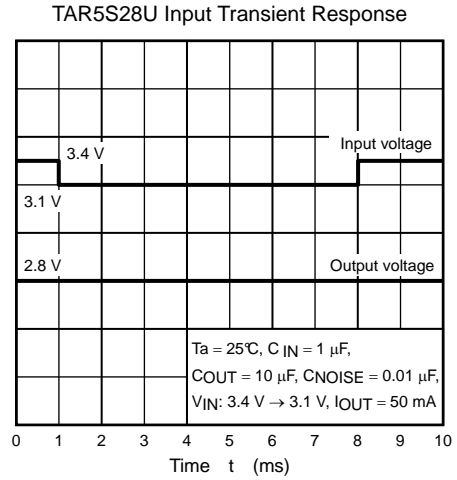
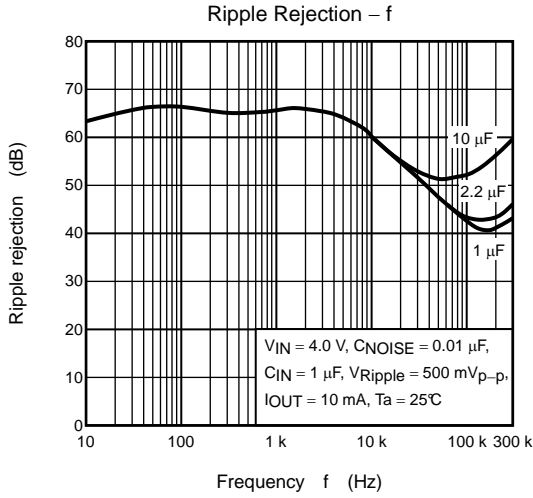

**4. NOISE Pin**

The TAR5SxxU have a pin named NOISE. To reduce the output noise and ensure stable operation, a capacitor should be inserted between the NOISE pin and GND. The capacitance value should be at least 0.0047  $\mu\text{F}$ .

The output voltage rise time varies with the value of the capacitor connected to the NOISE pin.

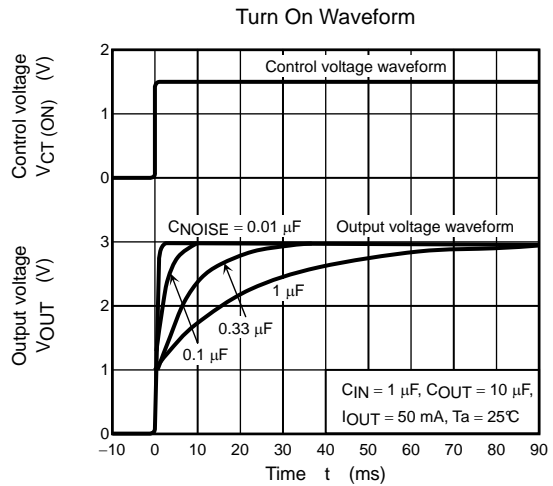
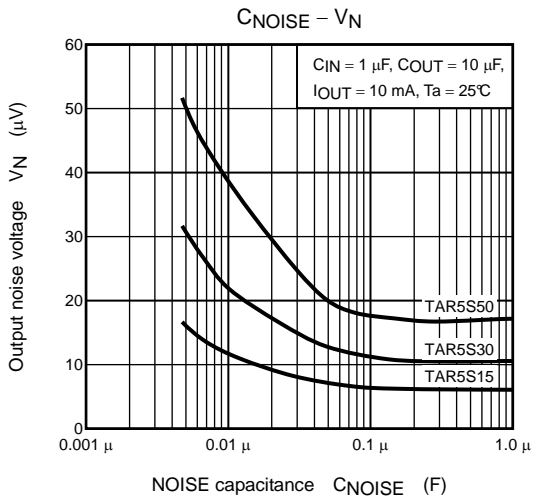

**5. Examples of Performance Curves When Ceramic Capacitors Are Used**

The stable operating area (SOA) is an area where the output voltage does not go into oscillation. The following figures represent the SOA obtained using an evaluation circuit shown below. The SOA is determined by the equivalent series resistance (ESR) of the output capacitor and the output current. The TAR5SxxU provide stable operation even when a ceramic capacitor is used as the output capacitor.

If the ripple frequency is 30 kHz or greater, the ripple rejection characteristics differ, depending on the type of the output capacitor (ceramic or tantalum) as shown by the bottom figure on this page.

It is recommended to verify that TAR5SxxU operate properly under the intended conditions of use.

**Examples of Safe Operating Area Characteristics**

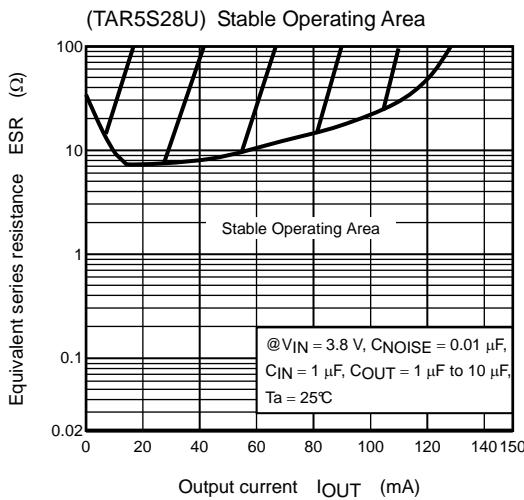
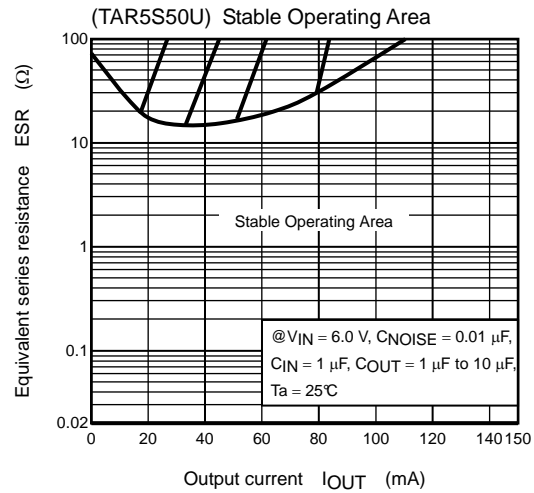
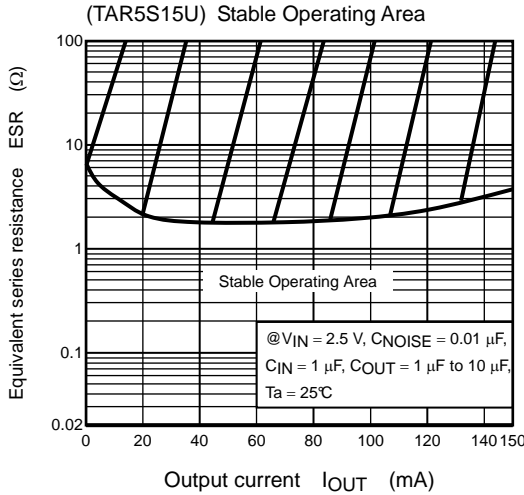

**Circuit for Stable Operating Area Evaluation**

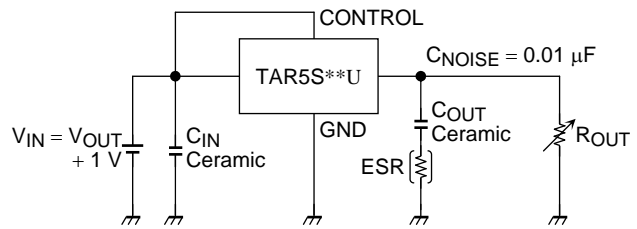

Capacitors used for evaluation  
 CIN: Murata GRM40B105K  
 COUT: Murata GRM40B105K / GRM40B106K

**Ripple Rejection Characteristic (f = 10 kHz to 300 kHz)**

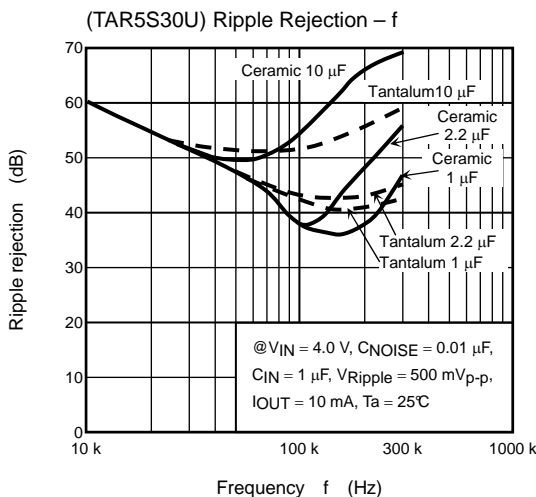

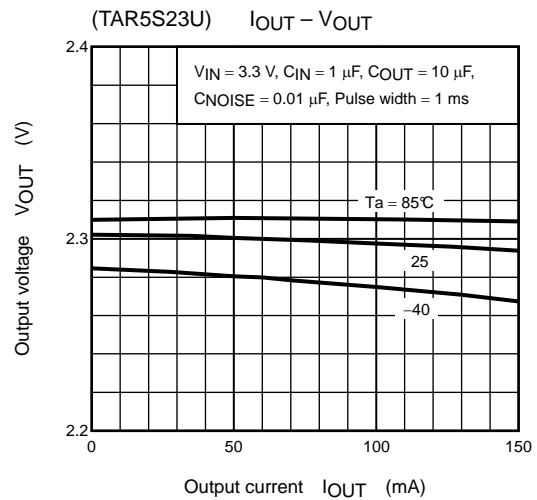
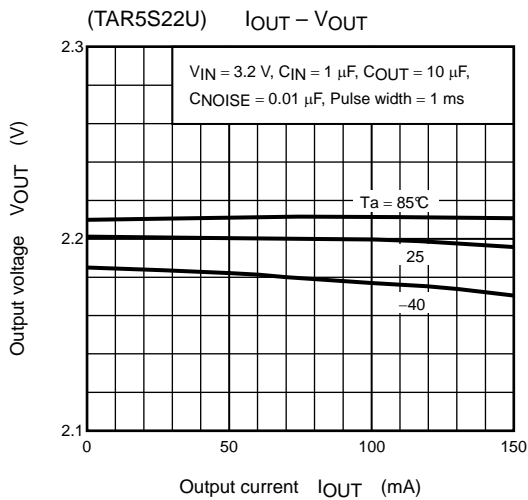
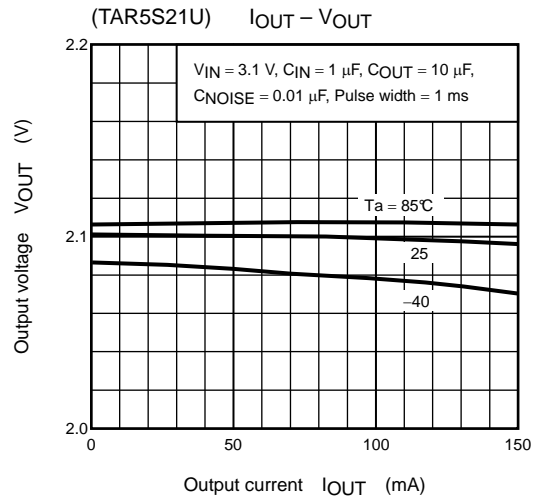
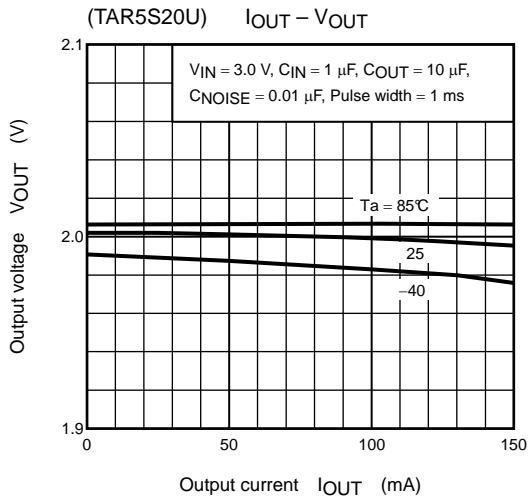
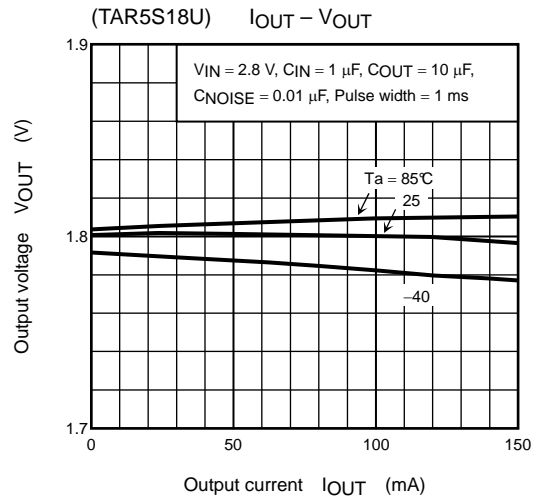
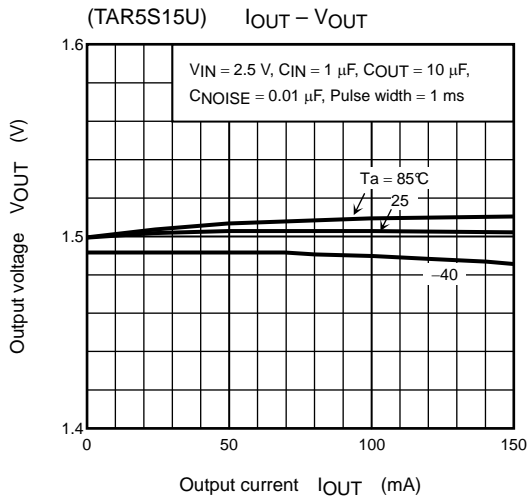



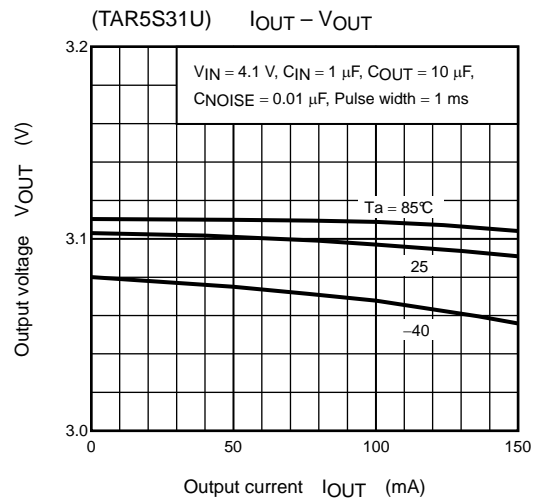
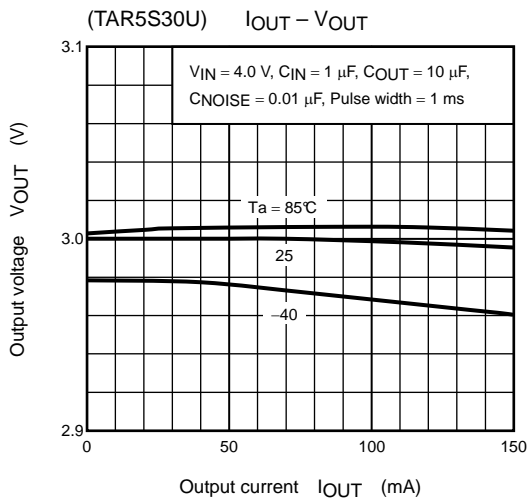
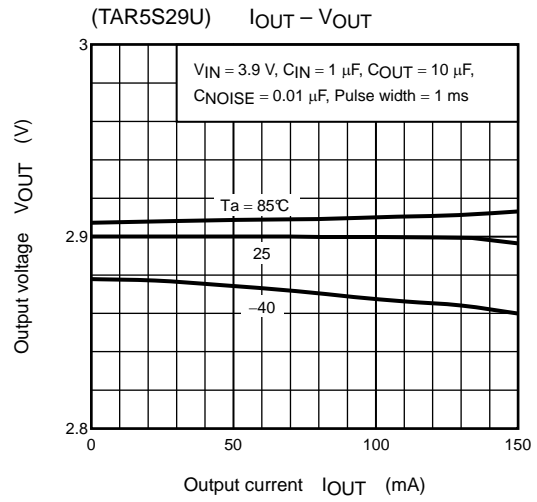
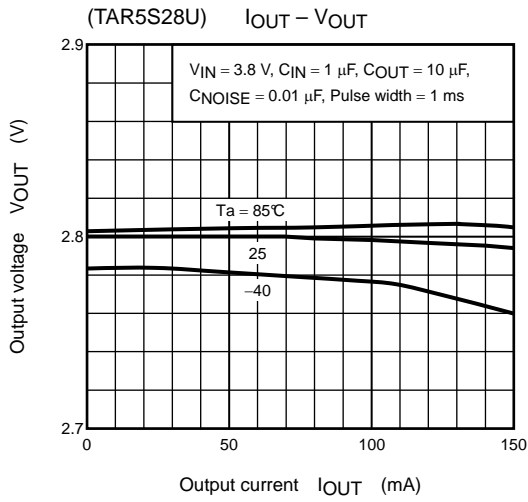
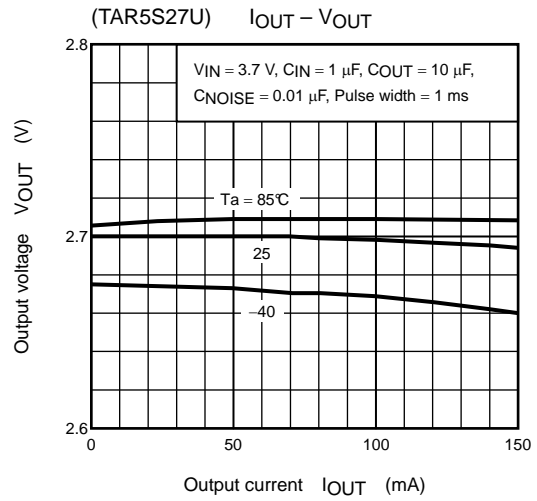
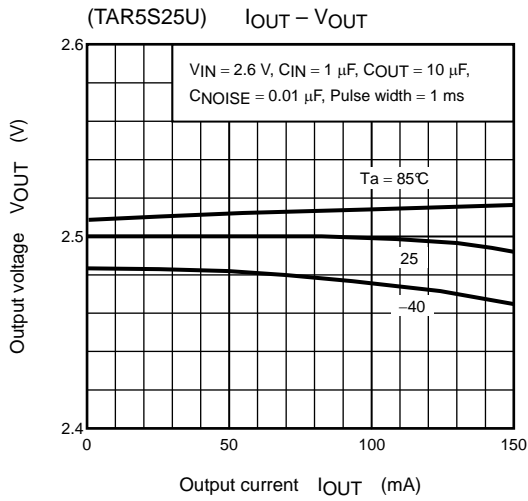

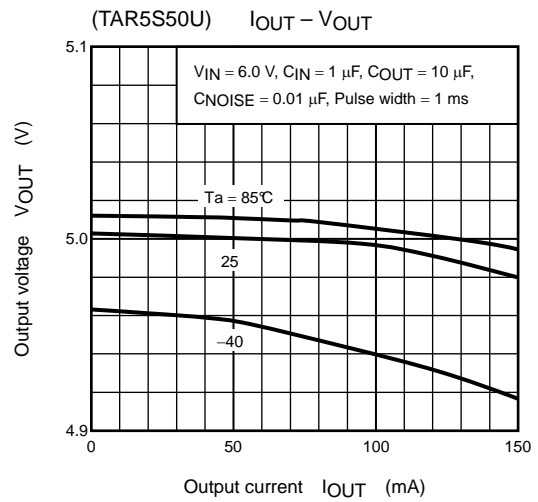
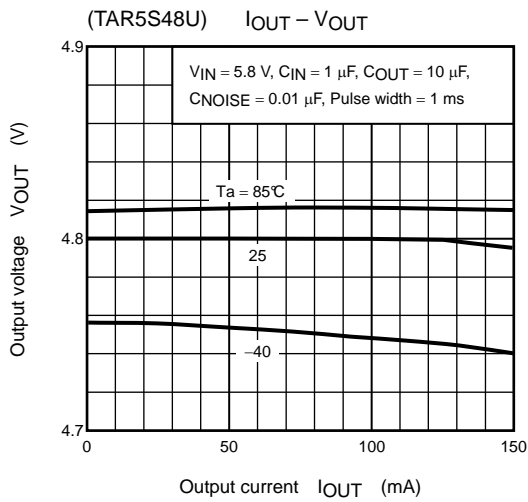
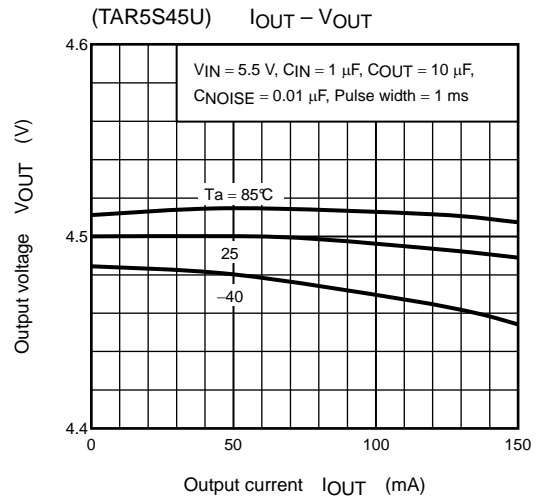
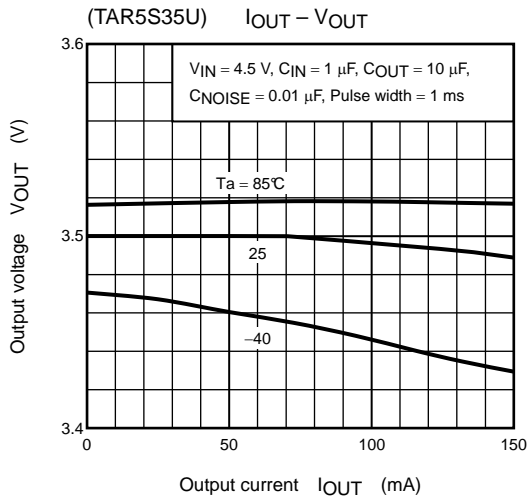
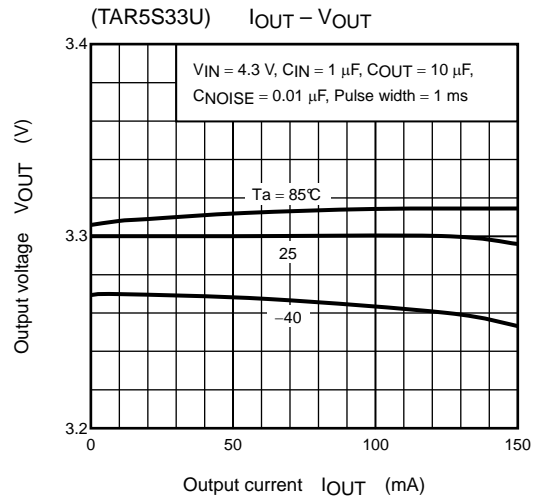
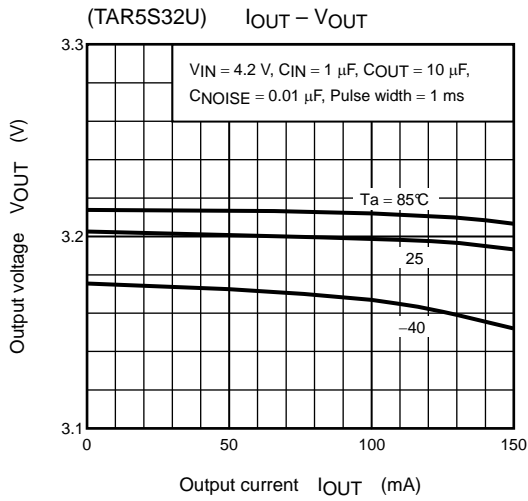

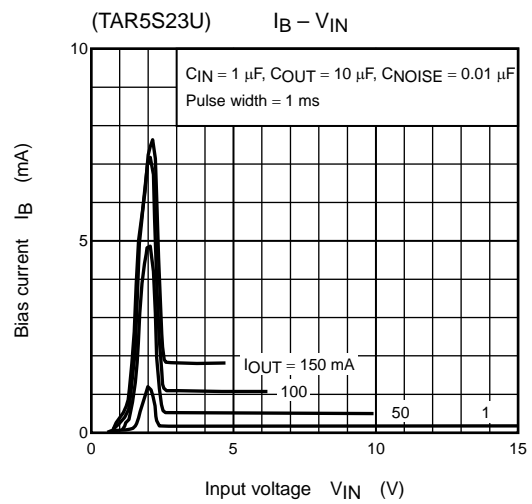
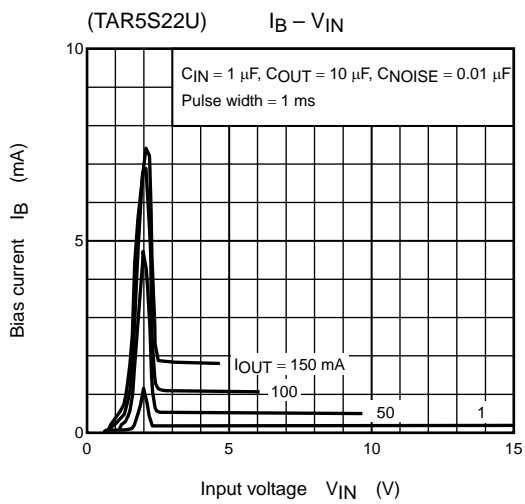
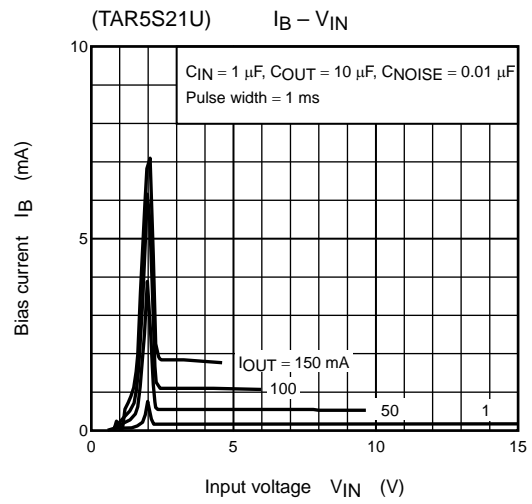
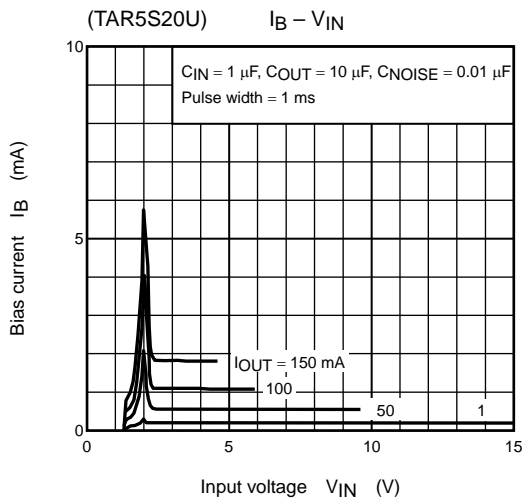
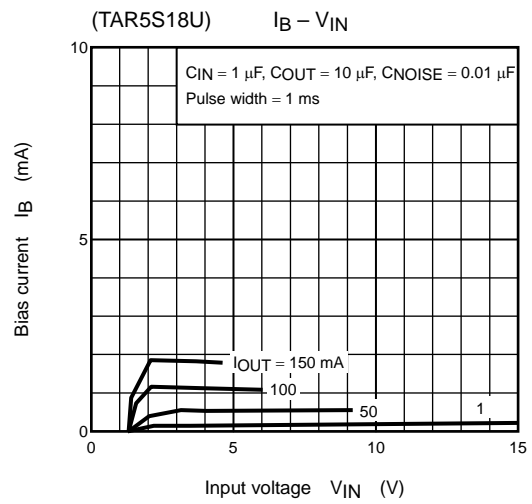
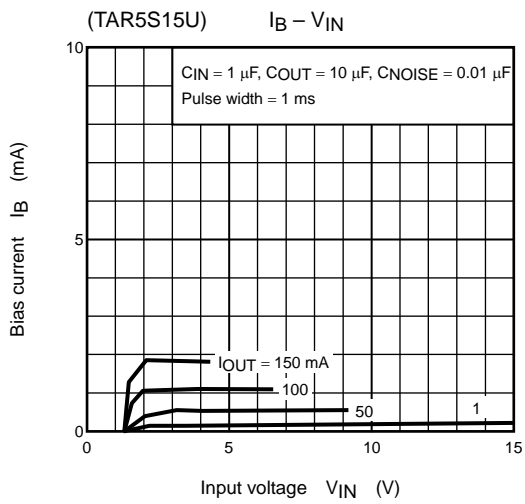

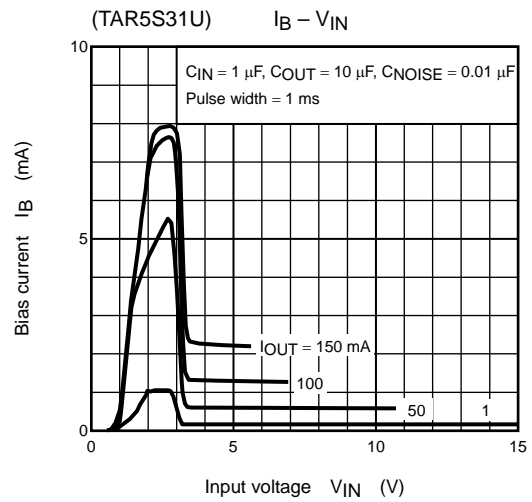
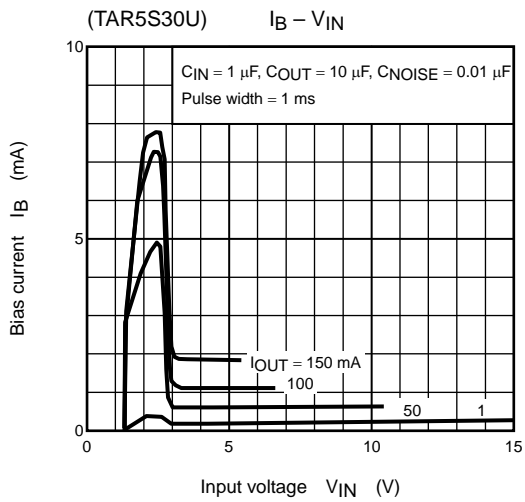
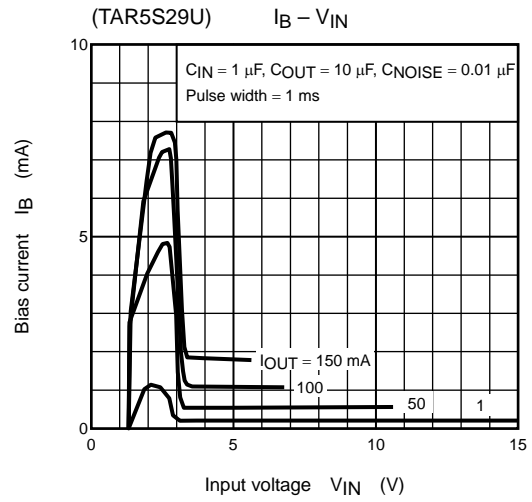
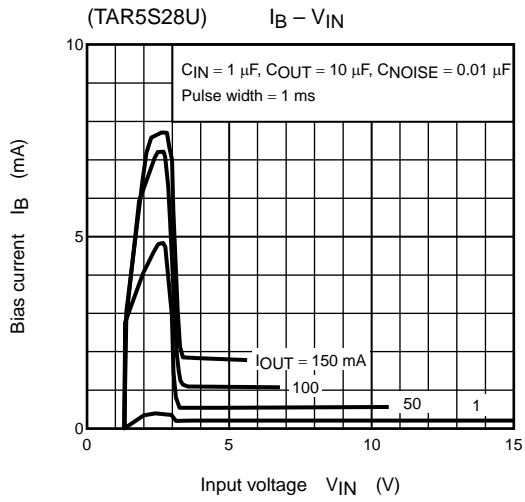
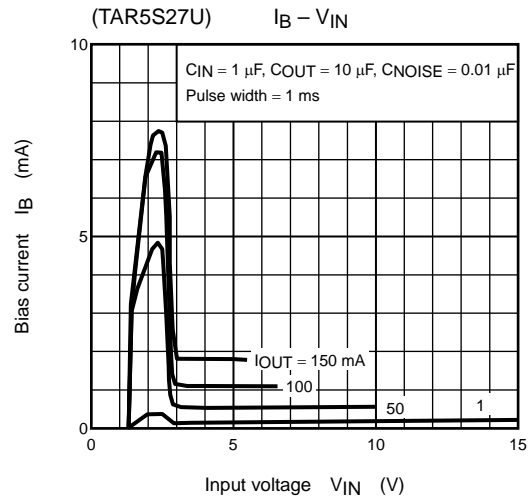
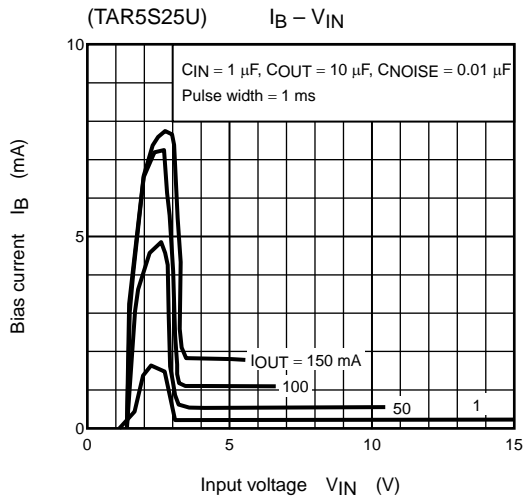

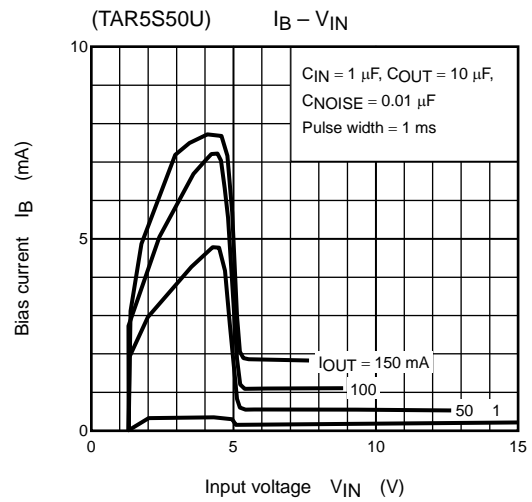
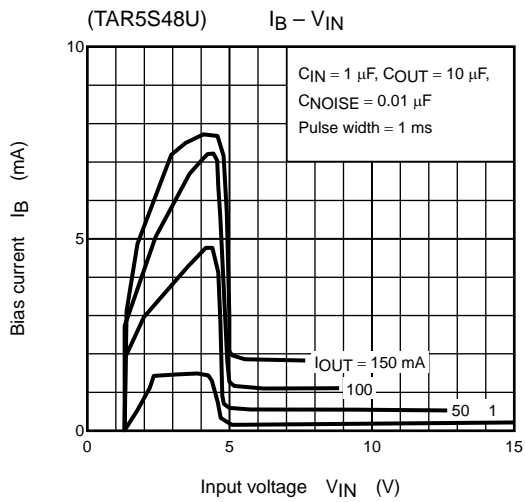
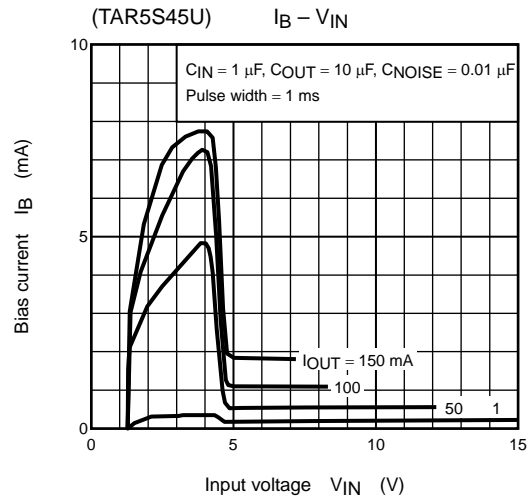
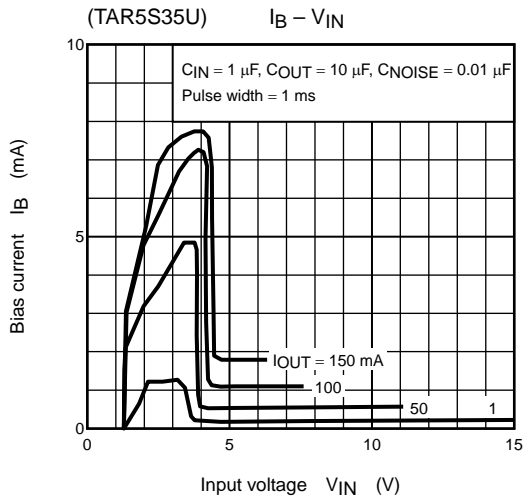
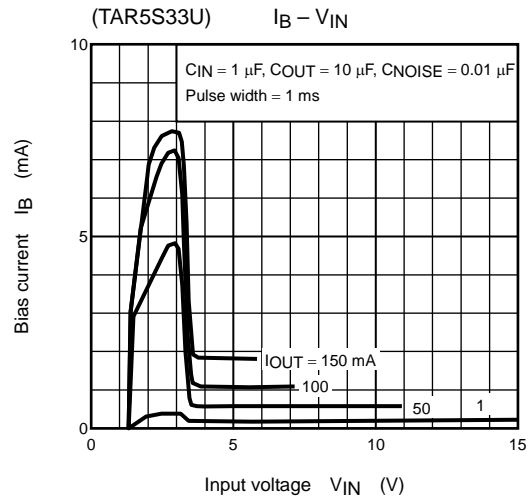
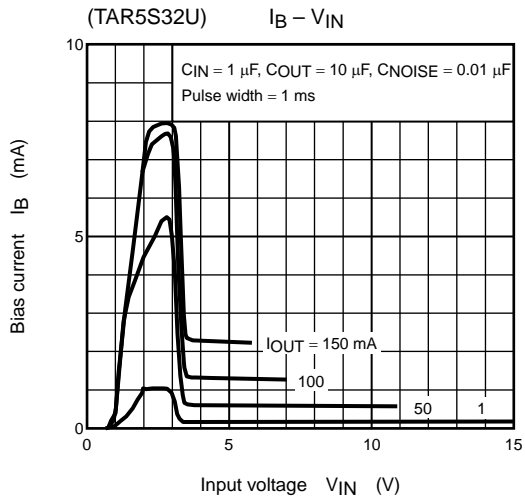

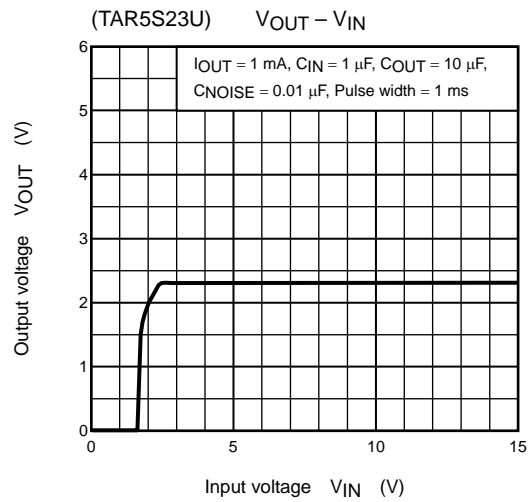
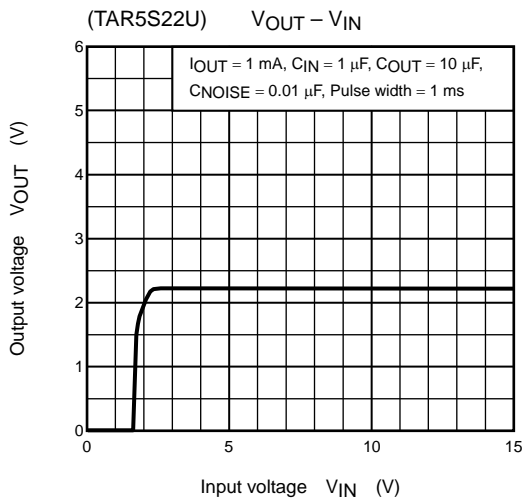
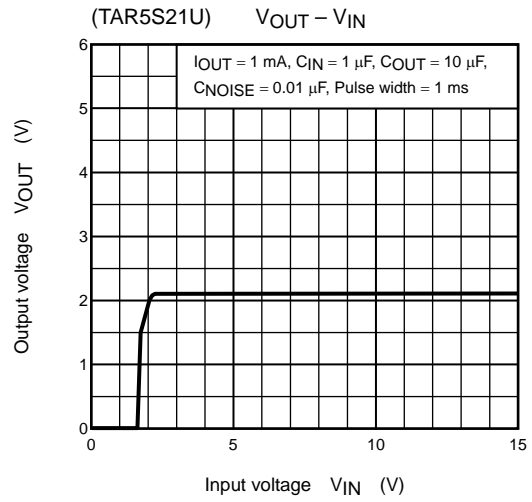
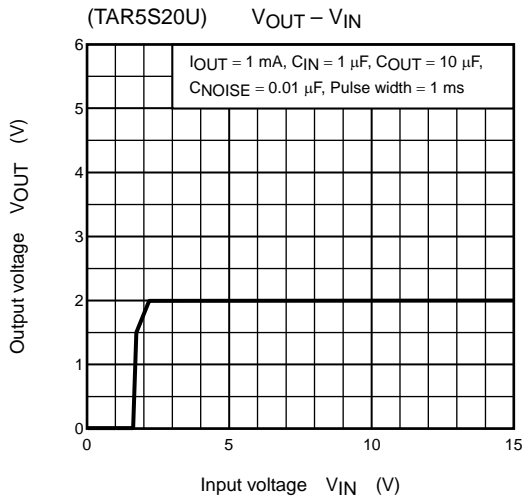
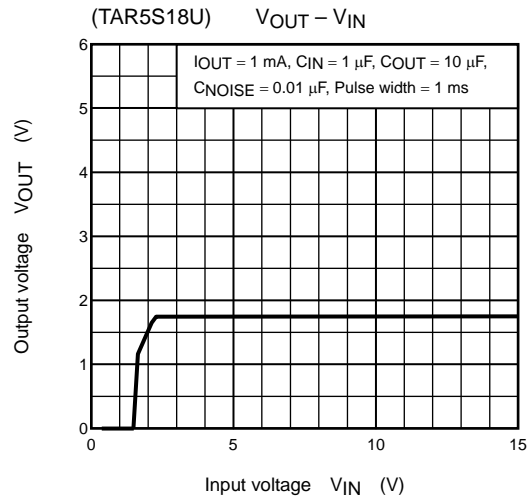
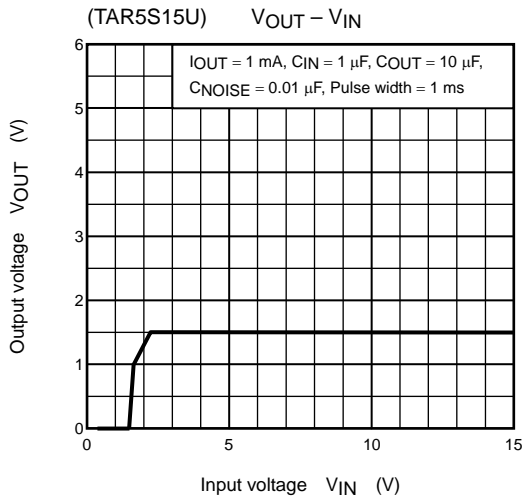

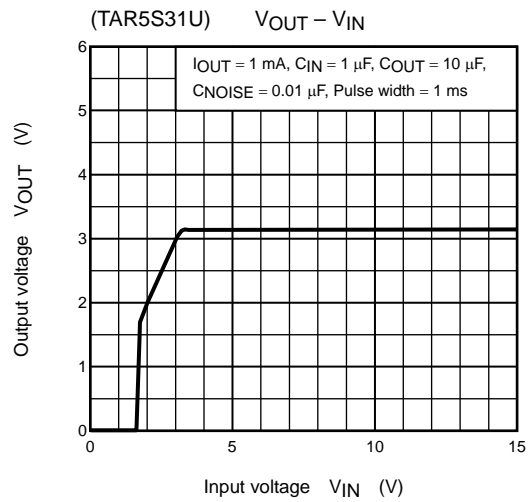
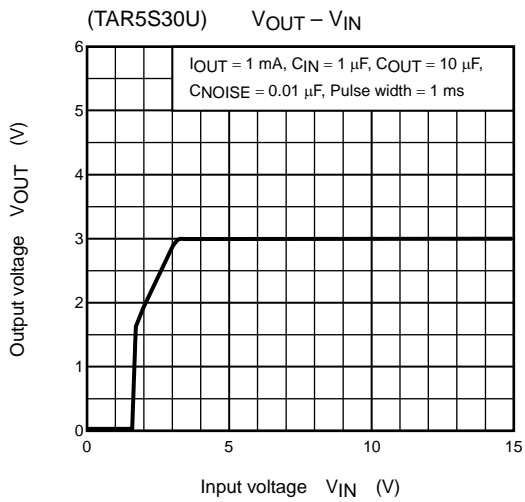
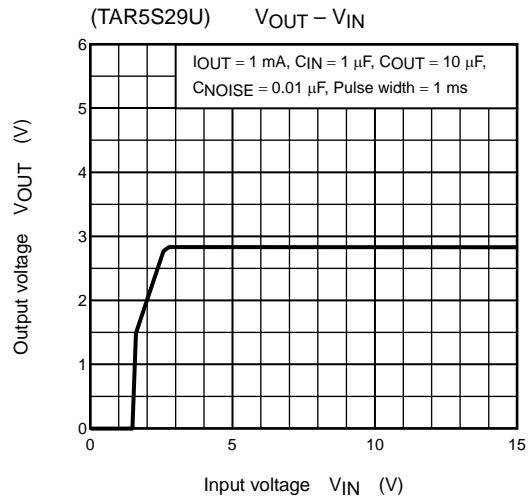
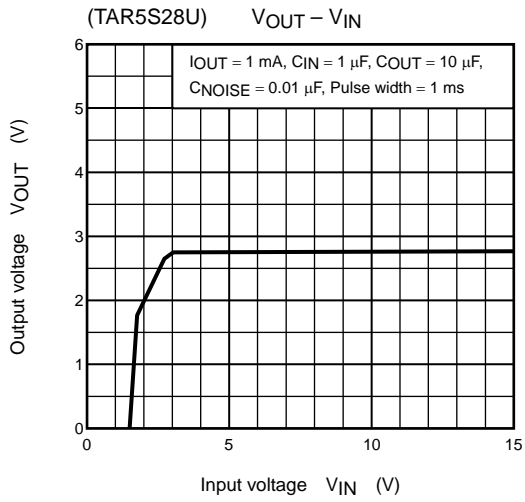
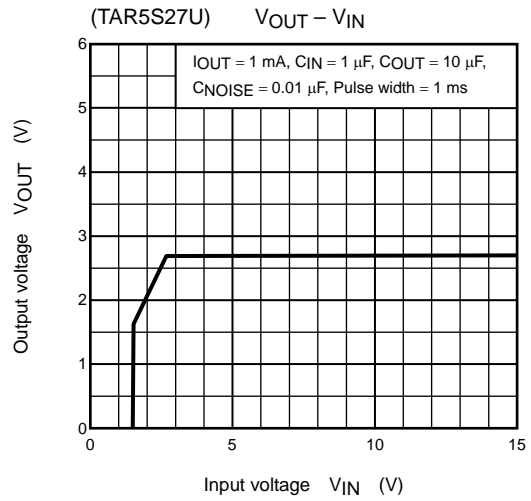
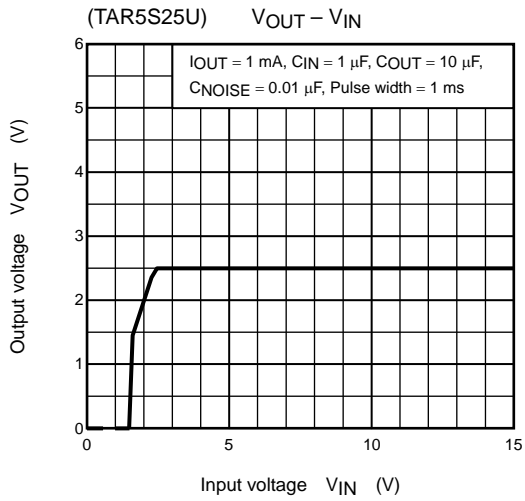

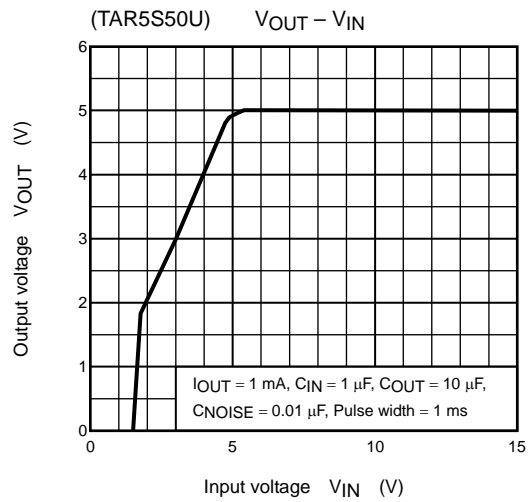
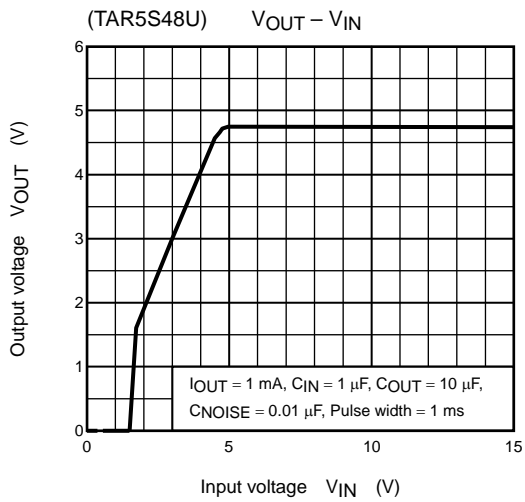
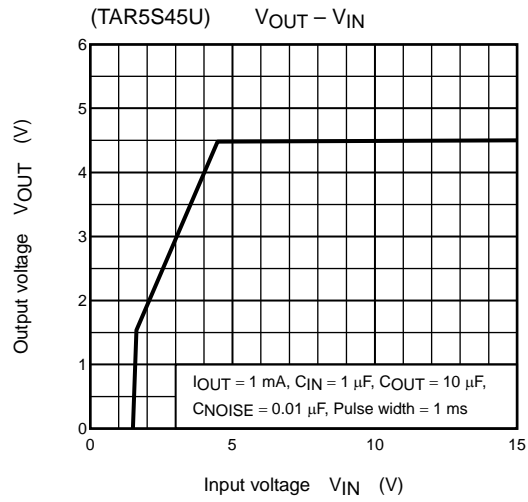
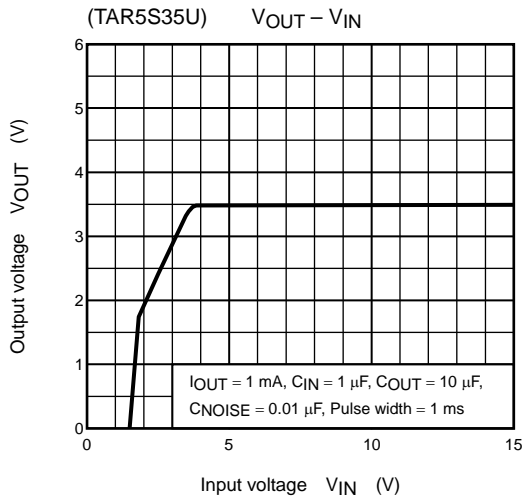
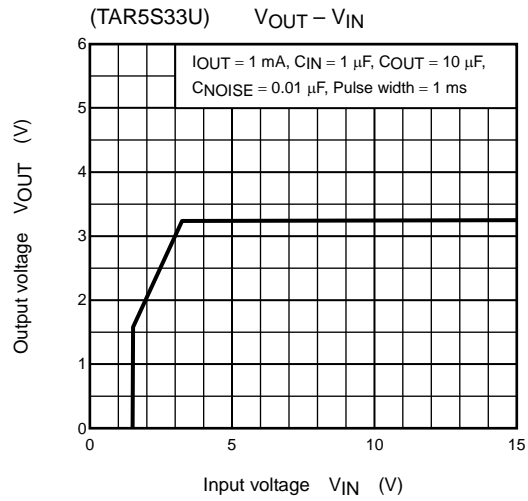
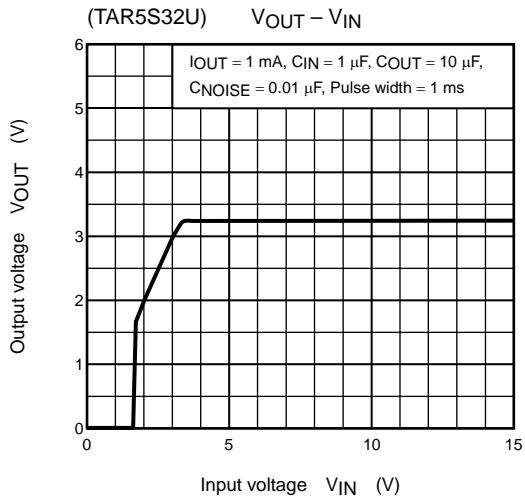



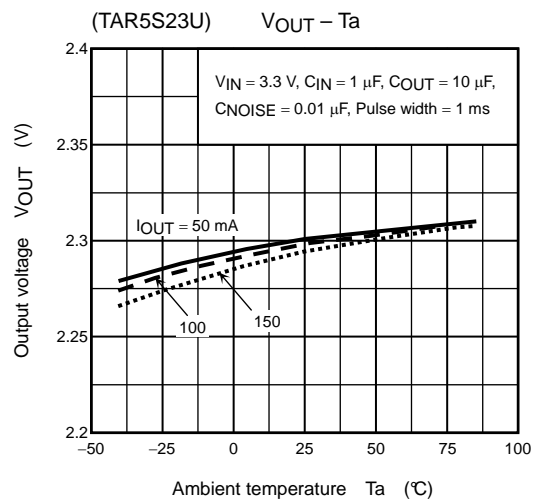
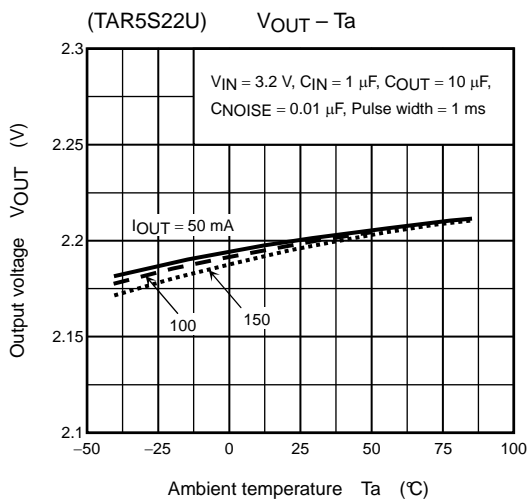
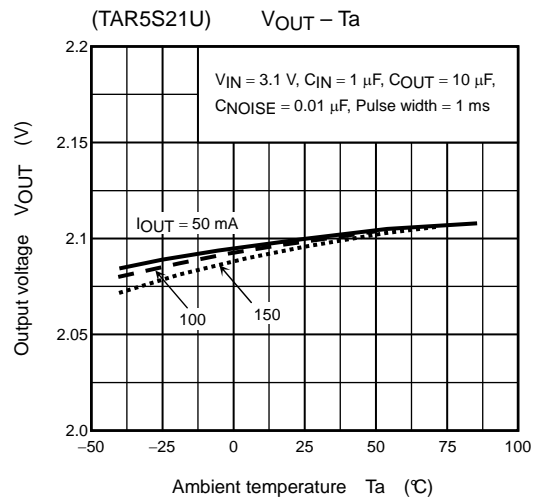
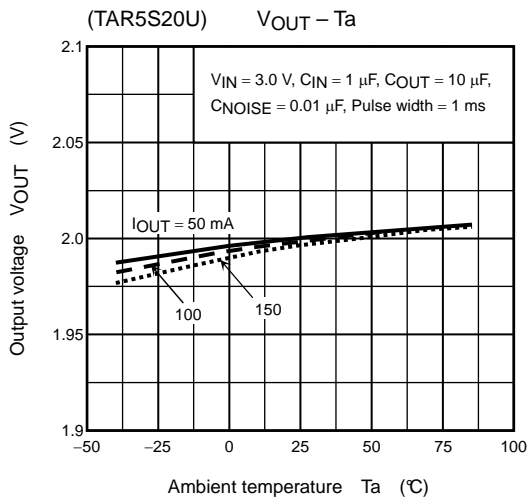
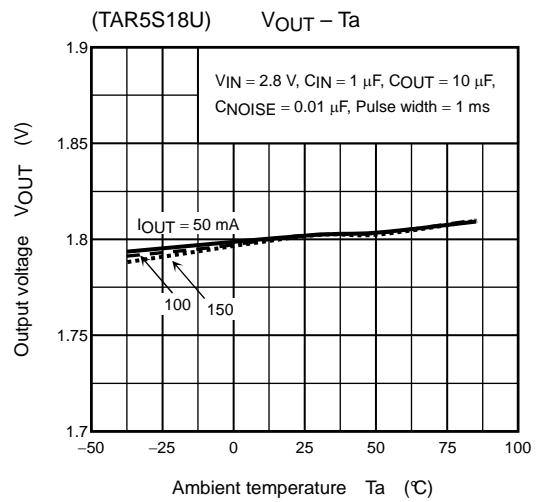
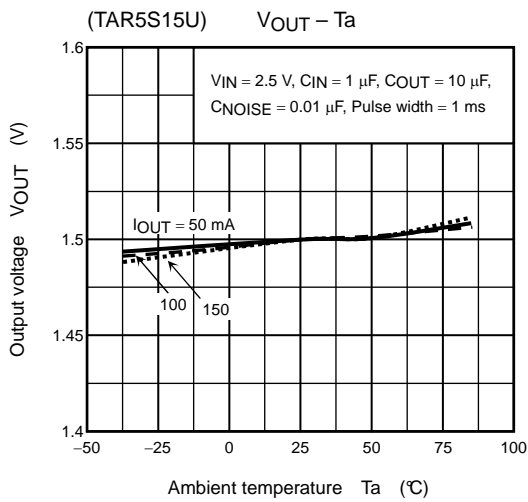

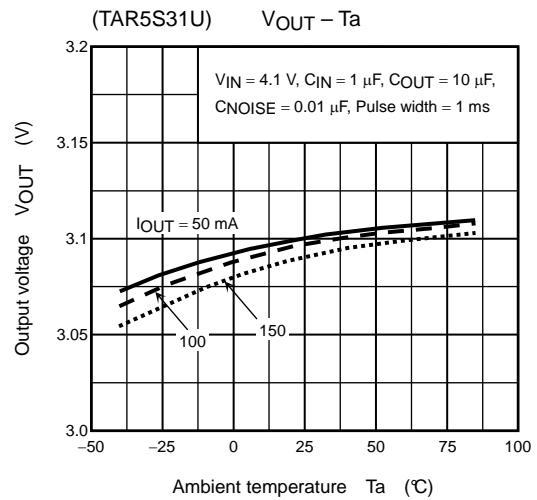
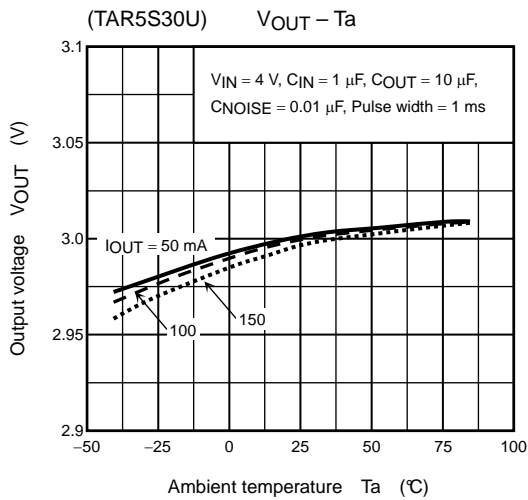
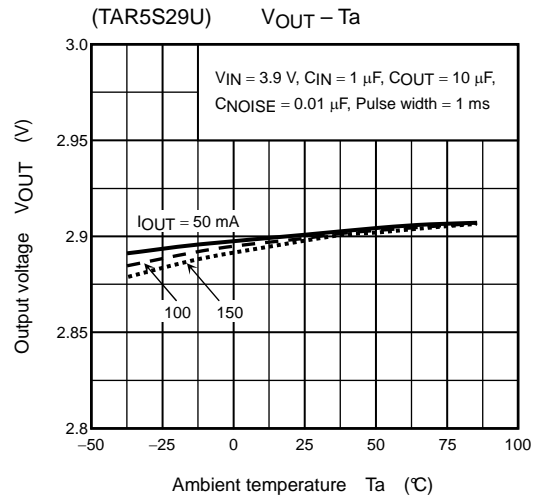
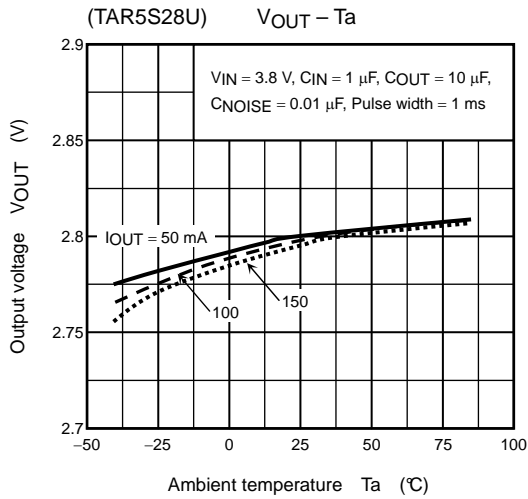
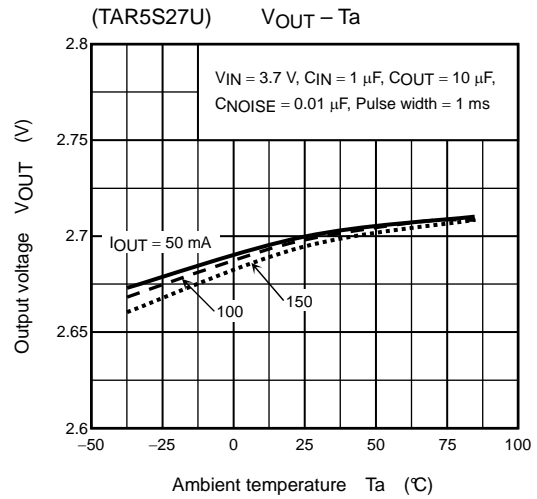
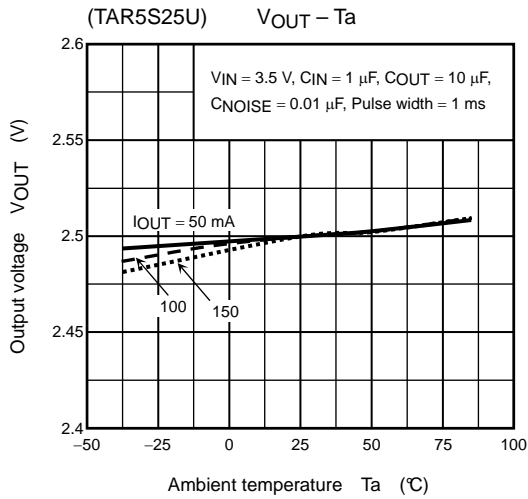

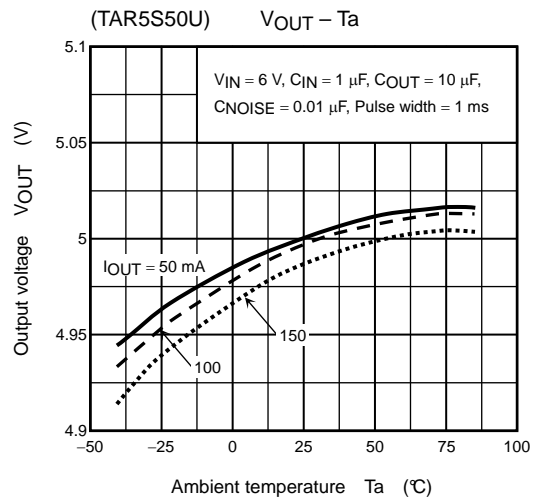
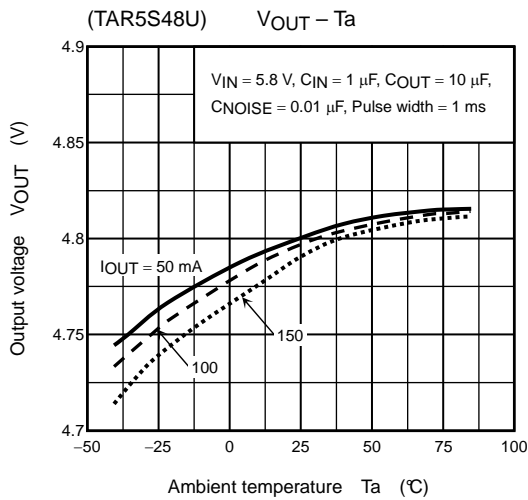
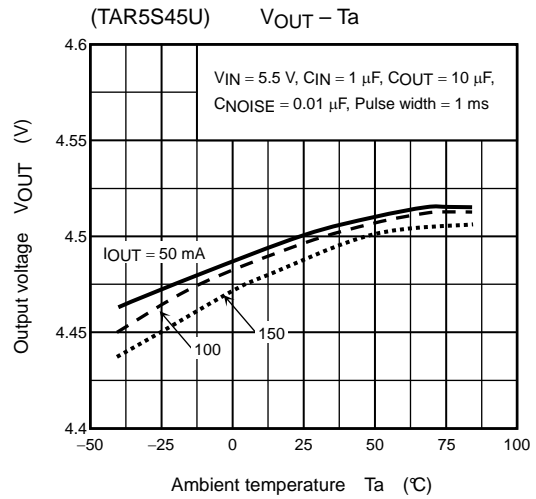
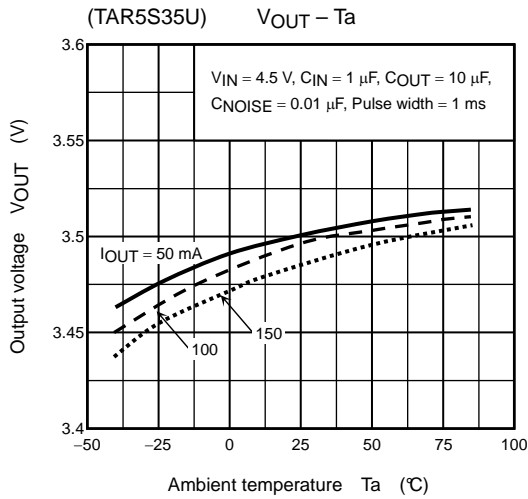
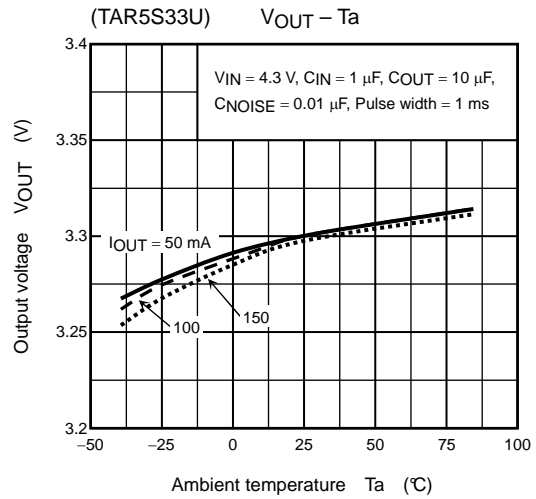
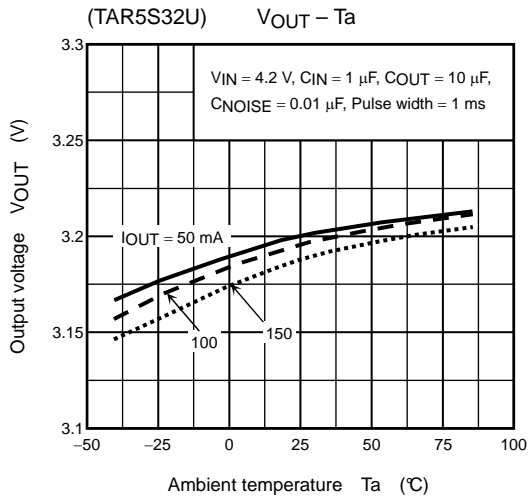

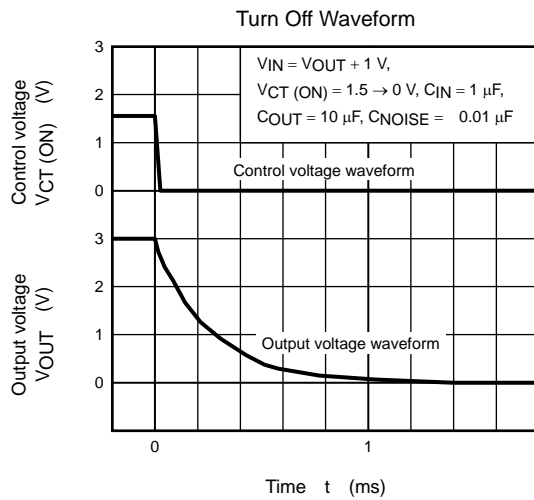
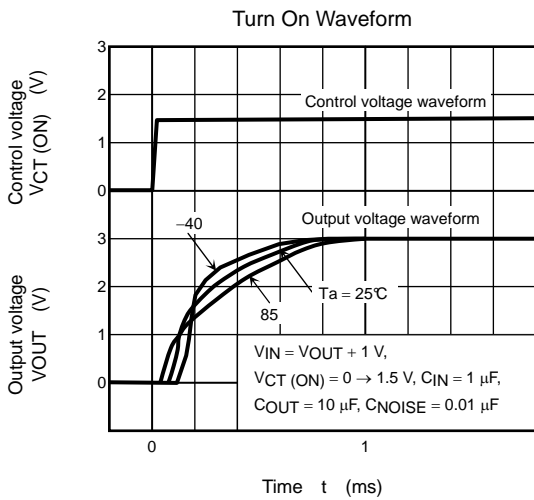
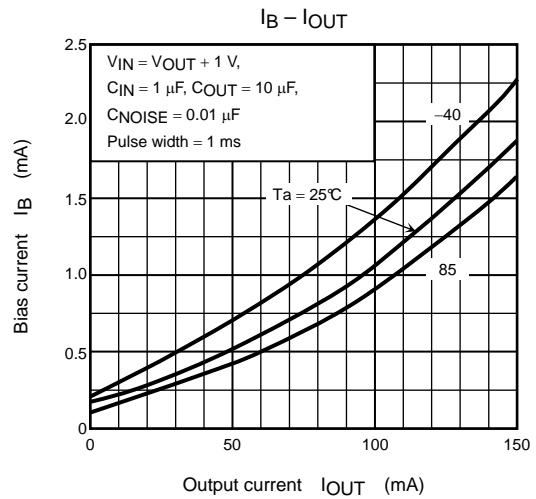
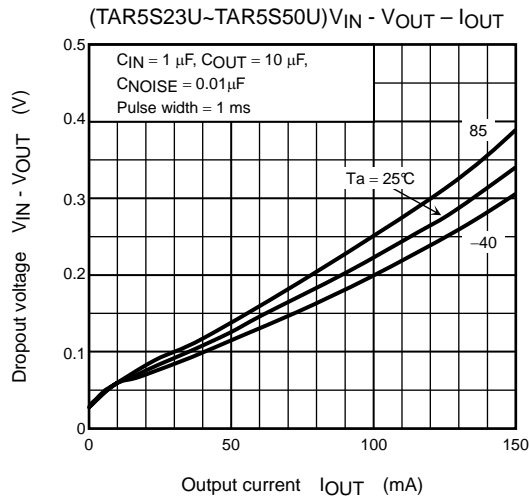
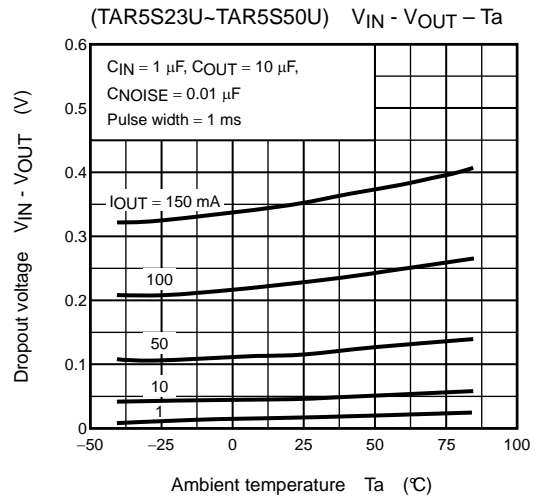
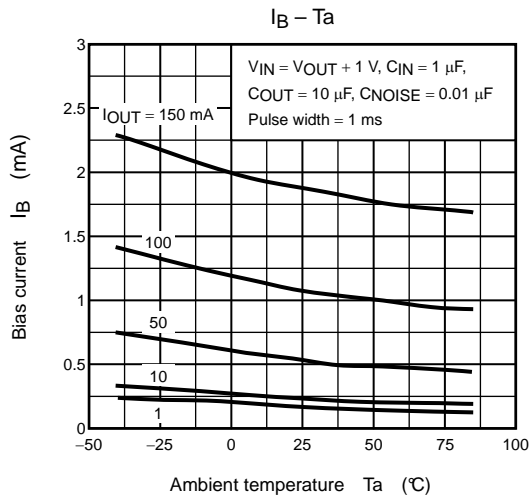

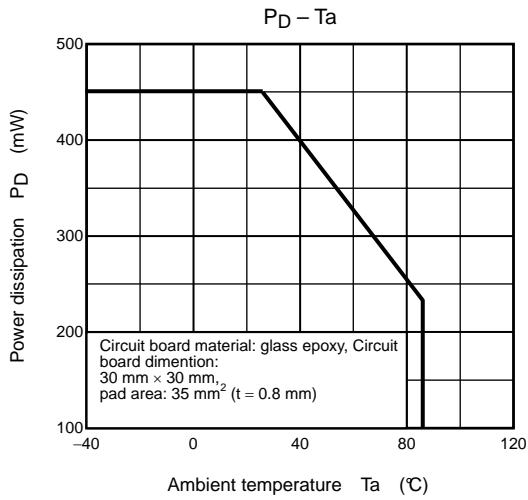
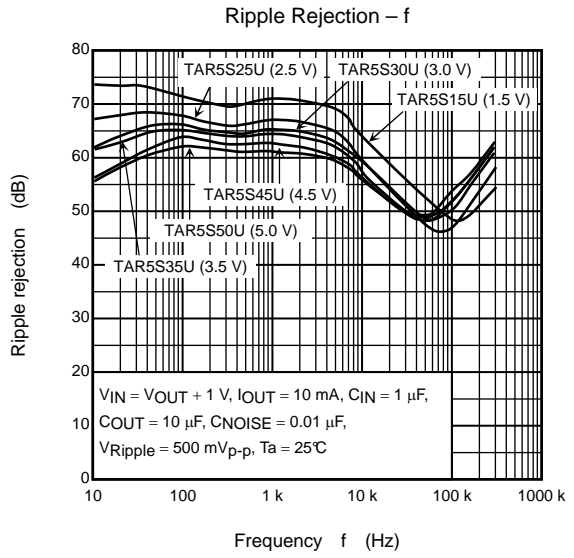
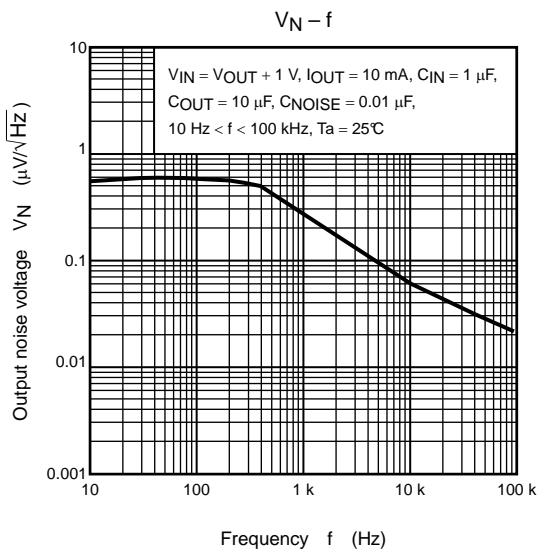

**Package Dimensions**

SON5-P-0202-0.65

Unit: mm

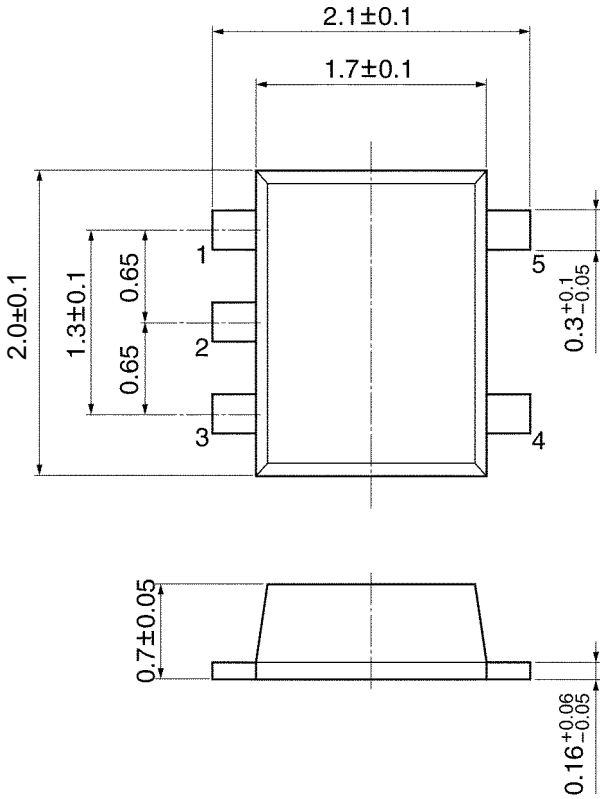

Weight: 0.007 g (typ.)

**RESTRICTIONS ON PRODUCT USE**

- Toshiba Corporation, and its subsidiaries and affiliates (collectively "TOSHIBA"), reserve the right to make changes to the information in this document, and related hardware, software and systems (collectively "Product") without notice.
- This document and any information herein may not be reproduced without prior written permission from TOSHIBA. Even with TOSHIBA's written permission, reproduction is permissible only if reproduction is without alteration/omission.
- Though TOSHIBA works continually to improve Product's quality and reliability, Product can malfunction or fail. Customers are responsible for complying with safety standards and for providing adequate designs and safeguards for their hardware, software and systems which minimize risk and avoid situations in which a malfunction or failure of Product could cause loss of human life, bodily injury or damage to property, including data loss or corruption. Before creating and producing designs and using, customers must also refer to and comply with (a) the latest versions of all relevant TOSHIBA information, including without limitation, this document, the specifications, the data sheets and application notes for Product and the precautions and conditions set forth in the "TOSHIBA Semiconductor Reliability Handbook" and (b) the instructions for the application that Product will be used with or for. Customers are solely responsible for all aspects of their own product design or applications, including but not limited to (a) determining the appropriateness of the use of this Product in such design or applications; (b) evaluating and determining the applicability of any information contained in this document, or in charts, diagrams, programs, algorithms, sample application circuits, or any other referenced documents; and (c) validating all operating parameters for such designs and applications. **TOSHIBA ASSUMES NO LIABILITY FOR CUSTOMERS' PRODUCT DESIGN OR APPLICATIONS.**
- Product is intended for use in general electronics applications (e.g., computers, personal equipment, office equipment, measuring equipment, industrial robots and home electronics appliances) or for specific applications as expressly stated in this document. Product is neither intended nor warranted for use in equipment or systems that require extraordinarily high levels of quality and/or reliability and/or a malfunction or failure of which may cause loss of human life, bodily injury, serious property damage or serious public impact ("Unintended Use"). Unintended Use includes, without limitation, equipment used in nuclear facilities, equipment used in the aerospace industry, medical equipment, equipment used for automobiles, trains, ships and other transportation, traffic signaling equipment, equipment used to control combustions or explosions, safety devices, elevators and escalators, devices related to electric power, and equipment used in finance-related fields. Do not use Product for Unintended Use unless specifically permitted in this document.
- Do not disassemble, analyze, reverse-engineer, alter, modify, translate or copy Product, whether in whole or in part.
- Product shall not be used for or incorporated into any products or systems whose manufacture, use, or sale is prohibited under any applicable laws or regulations.
- The information contained herein is presented only as guidance for Product use. No responsibility is assumed by TOSHIBA for any infringement of patents or any other intellectual property rights of third parties that may result from the use of Product. No license to any intellectual property right is granted by this document, whether express or implied, by estoppel or otherwise.
- **ABSENT A WRITTEN SIGNED AGREEMENT, EXCEPT AS PROVIDED IN THE RELEVANT TERMS AND CONDITIONS OF SALE FOR PRODUCT, AND TO THE MAXIMUM EXTENT ALLOWABLE BY LAW, TOSHIBA (1) ASSUMES NO LIABILITY WHATSOEVER, INCLUDING WITHOUT LIMITATION, INDIRECT, CONSEQUENTIAL, SPECIAL, OR INCIDENTAL DAMAGES OR LOSS, INCLUDING WITHOUT LIMITATION, LOSS OF PROFITS, LOSS OF OPPORTUNITIES, BUSINESS INTERRUPTION AND LOSS OF DATA, AND (2) DISCLAIMS ANY AND ALL EXPRESS OR IMPLIED WARRANTIES AND CONDITIONS RELATED TO SALE, USE OF PRODUCT, OR INFORMATION, INCLUDING WARRANTIES OR CONDITIONS OF MERCHANTABILITY, FITNESS FOR A PARTICULAR PURPOSE, ACCURACY OF INFORMATION, OR NONINFRINGEMENT.**
- Do not use or otherwise make available Product or related software or technology for any military purposes, including without limitation, for the design, development, use, stockpiling or manufacturing of nuclear, chemical, or biological weapons or missile technology products (mass destruction weapons). Product and related software and technology may be controlled under the Japanese Foreign Exchange and Foreign Trade Law and the U.S. Export Administration Regulations. Export and re-export of Product or related software or technology are strictly prohibited except in compliance with all applicable export laws and regulations.
- Please contact your TOSHIBA sales representative for details as to environmental matters such as the RoHS compatibility of Product. Please use Product in compliance with all applicable laws and regulations that regulate the inclusion or use of controlled substances, including without limitation, the EU RoHS Directive. TOSHIBA assumes no liability for damages or losses occurring as a result of noncompliance with applicable laws and regulations.