

TOSHIBA Bipolar Linear Integrated Circuit Silicon Monolithic

**TA58L05S,TA58L06S,TA58L08S,TA58L09S
TA58L10S,TA58L12S,TA58L15S****250 mA Low Dropout Voltage Regulator**

The TA58L**S Series consists of fixed-positive-output, low-dropout regulators with an output current of 250 mA (max) that utilize PNP transistors for the output stage. Low dropout voltage and standby current make the TA58L**S Series suitable for applications requiring low power consumption.

Features

- Maximum output current : 250 mA
- Output voltage : 5/ 6/ 8/ 9/ 10/ 12/ 15 V
- Output voltage accuracy : $V_{OUT} \pm 3\%$ (@ $T_j = 25^\circ\text{C}$)
- Low-dropout voltage : 0.4 V (max) (@ $I_{OUT} = 200$ mA)
- Protection function : Overcurrent protection / overheating protection / Reverse connection of power supply / 60 V load dump
- Package type : TO-220NIS

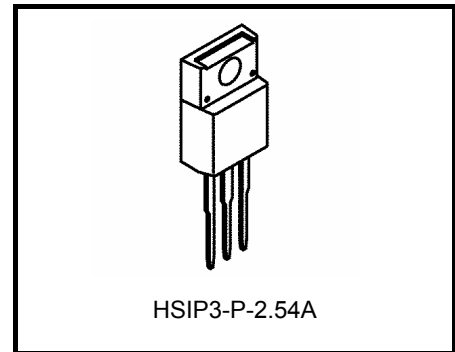

Weight : 1.7 g (typ.)

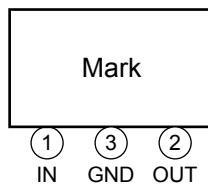
Pin Assignment

Marking

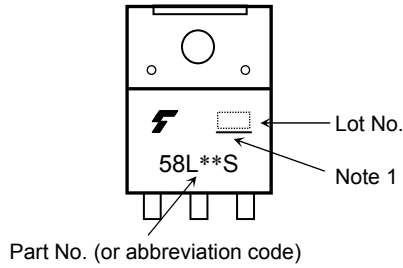

Note 1: A line under a Lot No. identifies the indication of product Labels.
 Not underlined: $[[Pb]]/INCLUDES > MCV$
 Underlined: $[[G]]/RoHS COMPATIBLE$ or $[[G]]/RoHS [[Pb]]$

Please contact your TOSHIBA sales representative for details as to environmental matters such as the RoHS compatibility of Product. The RoHS is the Directive 2002/95/EC of the European Parliament and of the Council of 27 January 2003 on the restriction of the use of certain hazardous substances in electrical and electronic equipment.

Note 2: The “**” in each product name is replaced with the output voltage of each product.

The product(s) in this document (“Product”) contain functions intended to protect the Product from temporary small overloads such as minor short-term overcurrent, overvoltage, or overheating. The protective functions do not necessarily protect Product under all circumstances. When incorporating Product into your system, please design the system (1) to avoid such overloads upon the Product, and (2) to shut down or otherwise relieve the Product of such overload conditions immediately upon occurrence. For details, please refer to the notes appearing below in this document and other documents referenced in this document.

Pin Description

Pin No.	Symbol	Description
1	IN	Input terminal. Connected by capacitor (C_{IN}) to GND.
3	GND	Ground terminal
2	OUT	Output terminal. Connected by capacitor (C_{OUT}) to GND.

How to Order

Product No.	Package	Package Type and Capacity
TA58L**S(Q) (Note 3)	TO-220NIS	Loose in bag: 50 (1 bag)

Note 3: The “**” in each product number is replaced with the output voltage of each product.

Block Diagram

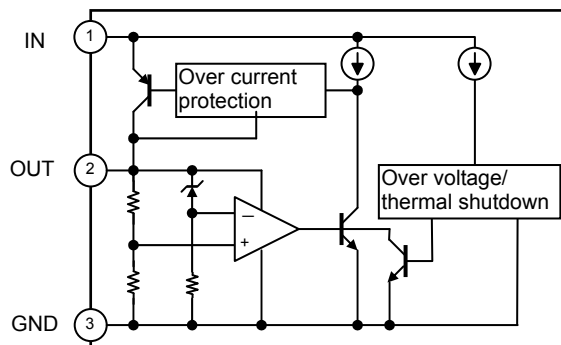

Absolute Maximum Rating (Ta = 25°C)

Characteristic		Symbol	Rating	Unit
Input voltage	DC	V _{IN (DC)}	29	V
	Pulse	V _{IN (Pulse)}	60 (τ = 200ms)	V
Output current		I _{OUT}	250	mA
Operating temperature		T _{opr}	-40 to 105	°C
Junction temperature		T _j	150	°C
Storage temperature		T _{stg}	-55 to 150	°C
Power dissipation	Ta = 25°C	P _D	2	W
	Tc = 25°C		20	

Note 4: Do not apply current and voltage (including reverse polarity) to any pin that is not specified.

Note 5: Using continuously under heavy loads (e.g. the application of high temperature/current/voltage and the significant change in temperature, etc.) may cause this product to decrease in the reliability significantly even if the operating conditions (i.e. operating temperature/current/voltage, etc.) are within the absolute maximum ratings and the operating ranges.

Please design the appropriate reliability upon reviewing the Toshiba Semiconductor Reliability Handbook ("Handling Precautions"/"Derating Concept and Methods") and individual reliability data (i.e. reliability test report and estimated failure rate, etc).

Thermal Characteristics

Characteristic	Symbol	Max	Unit
Thermal resistance, junction to ambient	R _{th (j-a)}	62.5	°C/ W
Thermal resistance, junction to case	R _{th (j-c)}	6.25	°C/ W

Protection Function (Reference)

Characteristic	Symbol	Test Condition	Min	Typ.	Max	Unit
Thermal shutdown	T _{SD}	V _{IN} = 14 V (05 to 06S)/ 16 V (08 to 10S)/ 18 V (12S)/ 20 V (15S)	—	170	—	°C
Peak circuit current	I _{PEAK}	V _{IN} = 14 V (05 to 06S)/ 16 V (08 to 10S)/ 18 V (12S)/ 20 V (15S), T _j = 25°C	—	600	—	mA
Short circuit current	I _{SC}	V _{IN} = 14 V (05 to 06S)/ 16 V (08 to 10S)/ 18 V (12S)/ 20 V (15S), T _j = 25°C	—	330	—	mA
Overvoltage protection	V _{IN}	T _j = 25°C	29	33	—	V

Note 6: Ensure that the devices operate within the limits of the maximum rating when in actual use.

Note 7: When the input voltage exceeds 29 V, the overvoltage protection circuit is activated to turn off the output voltage.

TA58L05S

Electrical Characteristics (unless otherwise specified, $T_j = 25^\circ\text{C}$)

Characteristic	Symbol	Test Condition	Min	Typ.	Max	Unit
Output voltage	V_{OUT}	$V_{IN} = 14\text{ V}, I_{OUT} = 10\text{ mA}$	4.85	5.00	5.15	V
		$5.35\text{ V} \leq V_{IN} \leq 26\text{ V}, I_{OUT} = 10\text{ mA}, -40^\circ\text{C} \leq T_a \leq 105^\circ\text{C}$	4.8	5.0	5.2	
Line regulation	Reg·line	$9\text{ V} \leq V_{IN} \leq 16\text{ V}, I_{OUT} = 10\text{ mA}$	—	1	10	mV
		$5.35\text{ V} \leq V_{IN} \leq 26\text{ V}, I_{OUT} = 10\text{ mA}$	—	2	15	
Load regulation	Reg·load	$V_{IN} = 14\text{ V}, 10\text{ mA} \leq I_{OUT} \leq 250\text{ mA}$	—	10	30	mV
Quiescent current	I_B	$6\text{ V} \leq V_{IN} \leq 26\text{ V}, I_{OUT} = 0\text{ A}$	—	0.45	1.00	mA
		$6\text{ V} \leq V_{IN} \leq 26\text{ V}, I_{OUT} = 250\text{ mA}$	—	25	50	
Dropout voltage	V_D	$I_{OUT} = 50\text{ mA}$	—	0.08	0.20	V
		$I_{OUT} = 200\text{ mA}$	—	0.22	0.40	

TA58L06S

Electrical Characteristics (unless otherwise specified, $T_j = 25^\circ\text{C}$)

Characteristic	Symbol	Test Condition	Min	Typ.	Max	Unit
Output voltage	V_{OUT}	$V_{IN} = 14\text{ V}, I_{OUT} = 10\text{ mA}$	5.82	6.00	6.18	V
		$6.35\text{ V} \leq V_{IN} \leq 26\text{ V}, I_{OUT} = 10\text{ mA}, -40^\circ\text{C} \leq T_a \leq 105^\circ\text{C}$	5.76	6.00	6.24	
Line regulation	Reg·line	$10\text{ V} \leq V_{IN} \leq 17\text{ V}, I_{OUT} = 10\text{ mA}$	—	1	10	mV
		$6.35\text{ V} \leq V_{IN} \leq 26\text{ V}, I_{OUT} = 10\text{ mA}$	—	2	15	
Load regulation	Reg·load	$V_{IN} = 14\text{ V}, 10\text{ mA} \leq I_{OUT} \leq 250\text{ mA}$	—	10	30	mV
Quiescent current	I_B	$7\text{ V} \leq V_{IN} \leq 26\text{ V}, I_{OUT} = 0\text{ A}$	—	0.5	1.0	mA
		$7\text{ V} \leq V_{IN} \leq 26\text{ V}, I_{OUT} = 250\text{ mA}$	—	25	50	
Dropout voltage	V_D	$I_{OUT} = 50\text{ mA}$	—	0.08	0.20	V
		$I_{OUT} = 200\text{ mA}$	—	0.22	0.40	

TA58L08S

Electrical Characteristics (unless otherwise specified, $T_j = 25^\circ\text{C}$)

Characteristic	Symbol	Test Condition	Min	Typ.	Max	Unit
Output voltage	V_{OUT}	$V_{IN} = 16\text{ V}, I_{OUT} = 10\text{ mA}$	7.76	8.00	8.24	V
		$8.35\text{ V} \leq V_{IN} \leq 26\text{ V}, I_{OUT} = 10\text{ mA}, -40^\circ\text{C} \leq T_a \leq 105^\circ\text{C}$	7.68	8.00	8.32	
Line regulation	Reg·line	$12\text{ V} \leq V_{IN} \leq 19\text{ V}, I_{OUT} = 10\text{ mA}$	—	1	10	mV
		$8.35\text{ V} \leq V_{IN} \leq 26\text{ V}, I_{OUT} = 10\text{ mA}$	—	2	15	
Load regulation	Reg·load	$V_{IN} = 16\text{ V}, 10\text{ mA} \leq I_{OUT} \leq 250\text{ mA}$	—	10	40	mV
Quiescent current	I_B	$9\text{ V} \leq V_{IN} \leq 26\text{ V}, I_{OUT} = 0\text{ A}$	—	0.55	1.00	mA
		$9\text{ V} \leq V_{IN} \leq 26\text{ V}, I_{OUT} = 250\text{ mA}$	—	25	50	
Dropout voltage	V_D	$I_{OUT} = 50\text{ mA}$	—	0.08	0.20	V
		$I_{OUT} = 200\text{ mA}$	—	0.22	0.40	

TA58L09S

Electrical Characteristics (unless otherwise specified, $T_j = 25^\circ\text{C}$)

Characteristic	Symbol	Test Condition	Min	Typ.	Max	Unit
Output voltage	V_{OUT}	$V_{IN} = 16\text{ V}, I_{OUT} = 10\text{ mA}$	8.73	9.00	9.27	V
		$9.35\text{ V} \leq V_{IN} \leq 26\text{ V}, I_{OUT} = 10\text{ mA}, -40^\circ\text{C} \leq T_a \leq 105^\circ\text{C}$	8.64	9.00	9.36	
Line regulation	Reg·line	$13\text{ V} \leq V_{IN} \leq 20\text{ V}, I_{OUT} = 10\text{ mA}$	—	1	12	mV
		$9.35\text{ V} \leq V_{IN} \leq 26\text{ V}, I_{OUT} = 10\text{ mA}$	—	2	20	
Load regulation	Reg·load	$V_{IN} = 16\text{ V}, 10\text{ mA} \leq I_{OUT} \leq 250\text{ mA}$	—	12	40	mV
Quiescent current	I_B	$10\text{ V} \leq V_{IN} \leq 26\text{ V}, I_{OUT} = 0\text{ A}$	—	0.6	1.0	mA
		$10\text{ V} \leq V_{IN} \leq 26\text{ V}, I_{OUT} = 250\text{ mA}$	—	25	50	
Dropout voltage	V_D	$I_{OUT} = 50\text{ mA}$	—	0.08	0.20	V
		$I_{OUT} = 200\text{ mA}$	—	0.22	0.40	

TA58L10S

Electrical Characteristics (unless otherwise specified, $T_j = 25^\circ\text{C}$)

Characteristic	Symbol	Test Condition	Min	Typ.	Max	Unit
Output voltage	V_{OUT}	$V_{IN} = 16\text{ V}, I_{OUT} = 10\text{ mA}$	9.7	10.0	10.3	V
		$10.35\text{ V} \leq V_{IN} \leq 26\text{ V}, I_{OUT} = 10\text{ mA}, -40^\circ\text{C} \leq T_a \leq 105^\circ\text{C}$	9.6	10.0	10.4	
Line regulation	Reg·line	$14\text{ V} \leq V_{IN} \leq 21\text{ V}, I_{OUT} = 10\text{ mA}$	—	1	12	mV
		$10.35\text{ V} \leq V_{IN} \leq 26\text{ V}, I_{OUT} = 10\text{ mA}$	—	2	20	
Load regulation	Reg·load	$V_{IN} = 16\text{ V}, 10\text{ mA} \leq I_{OUT} \leq 250\text{ mA}$	—	12	40	mV
Quiescent current	I_B	$11\text{ V} \leq V_{IN} \leq 26\text{ V}, I_{OUT} = 0\text{ A}$	—	0.6	1.2	mA
		$11\text{ V} \leq V_{IN} \leq 26\text{ V}, I_{OUT} = 250\text{ mA}$	—	25	50	
Dropout voltage	V_D	$I_{OUT} = 50\text{ mA}$	—	0.08	0.20	V
		$I_{OUT} = 200\text{ mA}$	—	0.22	0.40	

TA58L12S

Electrical Characteristics (unless otherwise specified, $T_j = 25^\circ\text{C}$)

Characteristic	Symbol	Test Condition	Min	Typ.	Max	Unit
Output voltage	V_{OUT}	$V_{IN} = 18\text{ V}, I_{OUT} = 10\text{ mA}$	11.64	12.00	12.36	V
		$12.35\text{ V} \leq V_{IN} \leq 26\text{ V}, I_{OUT} = 10\text{ mA}, -40^\circ\text{C} \leq T_a \leq 105^\circ\text{C}$	11.52	12.00	12.48	
Line regulation	Reg·line	$16\text{ V} \leq V_{IN} \leq 23\text{ V}, I_{OUT} = 10\text{ mA}$	—	1	12	mV
		$12.35\text{ V} \leq V_{IN} \leq 26\text{ V}, I_{OUT} = 10\text{ mA}$	—	2	20	
Load regulation	Reg·load	$V_{IN} = 18\text{ V}, 10\text{ mA} \leq I_{OUT} \leq 250\text{ mA}$	—	20	50	mV
Quiescent current	I_B	$13\text{ V} \leq V_{IN} \leq 26\text{ V}, I_{OUT} = 0\text{ A}$	—	0.65	1.20	mA
		$13\text{ V} \leq V_{IN} \leq 26\text{ V}, I_{OUT} = 250\text{ mA}$	—	25	50	
Dropout voltage	V_D	$I_{OUT} = 50\text{ mA}$	—	0.08	0.20	V
		$I_{OUT} = 200\text{ mA}$	—	0.22	0.40	

TA58L15S

Electrical Characteristics (unless otherwise specified, $T_j = 25^\circ\text{C}$)

Characteristic	Symbol	Test Condition	Min	Typ.	Max	Unit
Output voltage	V_{OUT}	$V_{\text{IN}} = 20 \text{ V}, I_{\text{OUT}} = 10 \text{ mA}$	14.55	15.00	15.45	V
		$15.35 \text{ V} \leq V_{\text{IN}} \leq 26 \text{ V}, I_{\text{OUT}} = 10 \text{ mA}, -40^\circ\text{C} \leq T_a \leq 105^\circ\text{C}$	14.4	15.0	15.6	
Line regulation	Reg·line	$19 \text{ V} \leq V_{\text{IN}} \leq 26 \text{ V}, I_{\text{OUT}} = 10 \text{ mA}$	—	1	12	mV
		$15.35 \text{ V} \leq V_{\text{IN}} \leq 26 \text{ V}, I_{\text{OUT}} = 10 \text{ mA}$	—	2	20	
Load regulation	Reg·load	$V_{\text{IN}} = 20 \text{ V}, 10 \text{ mA} \leq I_{\text{OUT}} \leq 250 \text{ mA}$	—	20	60	mV
Quiescent current	I_{B}	$16 \text{ V} \leq V_{\text{IN}} \leq 26 \text{ V}, I_{\text{OUT}} = 0 \text{ A}$	—	0.75	1.40	mA
		$16 \text{ V} \leq V_{\text{IN}} \leq 26 \text{ V}, I_{\text{OUT}} = 250 \text{ mA}$	—	25	50	
Dropout voltage	V_{D}	$I_{\text{OUT}} = 50 \text{ mA}$	—	0.08	0.20	V
		$I_{\text{OUT}} = 200 \text{ mA}$	—	0.22	0.40	

Electrical Characteristics Common to All Products

- $T_j = 25^\circ\text{C}$ in the measurement conditions of each item is the standard condition when a pulse test is carried out, and any drift in the electrical characteristic due to a rise in the junction temperature of the chip may be disregarded.

Standard Application Circuit

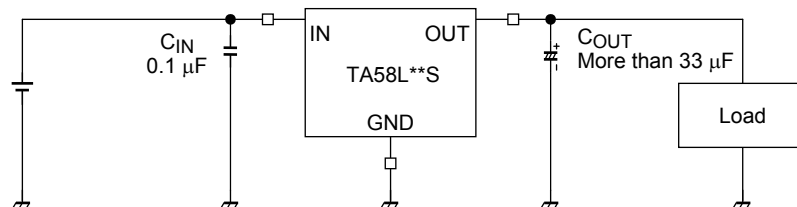

- Place C_{IN} as close as possible to the input terminal and GND. Place C_{OUT} as close as possible to the output terminal and GND. Although capacitor C_{OUT} acts to smooth the dc output voltage during suspension of output oscillation or load change, it might cause output oscillation in a cold environment due to increased capacitor ESR. It is therefore recommended to use a capacitor with small variations temperature sensitivity. Also, ensure that the regulator performance is satisfactory over the operating temperature range of the target system..

Usage Precautions

- Low voltage
Do not apply voltage to the Product that is lower than the minimum operating voltage, or the Product's protective functions will not operate properly and the Product may be permanently damaged.
- Overcurrent Protection
The overcurrent protection circuits in the Product are designed to temporarily protect Product from minor overcurrent of brief duration. When the overcurrent protective function in the Product activates, immediately cease application of overcurrent to Product. Improper usage of Product, such as application of current to Product exceeding the absolute maximum ratings, could cause the overcurrent protection circuit not to operate properly and/or damage Product permanently even before the protection circuit starts to operate.
- Overheating Protection
The thermal shutdown circuits in the Product are designed to temporarily protect Product from minor overheating of brief duration. When the overheating protective function in the Product activates, immediately correct the overheating situation. Improper usage of Product, such as the application of heat to Product exceeding the absolute maximum ratings, could cause the overheating protection circuit not to operate properly and/or damage Product permanently even before the protection circuit starts to operate.
- Overvoltage Protection
The overvoltage protection circuits in the Product are designed to temporarily protect Product from minor overvoltage of brief duration. When the overvoltage protective function in the Product activates, immediately cease application of overvoltage to Product. Improper usage of Product, such as application of voltage to Product exceeding the absolute maximum ratings, could cause the overvoltage protection circuit not to operate properly and/or damage Product permanently even before the protection circuit starts to operate.

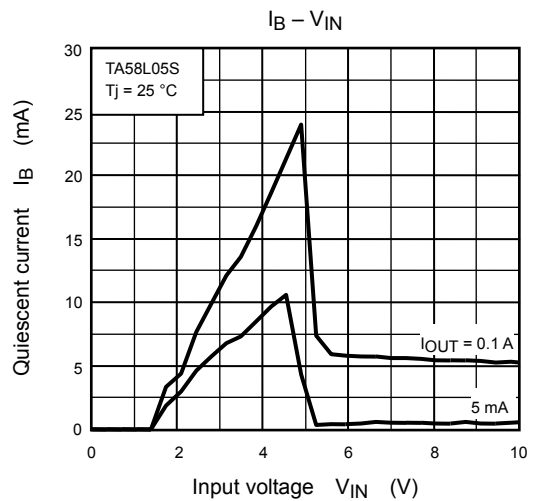
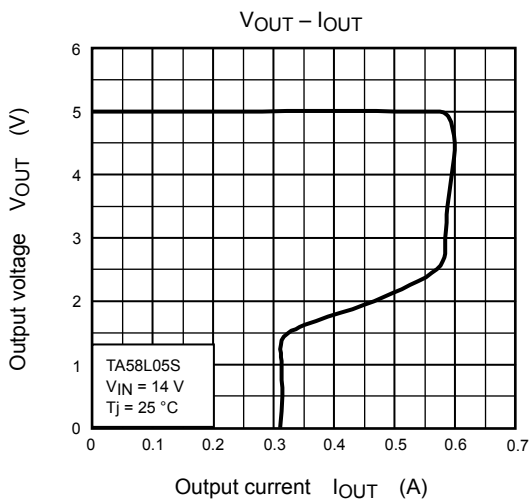
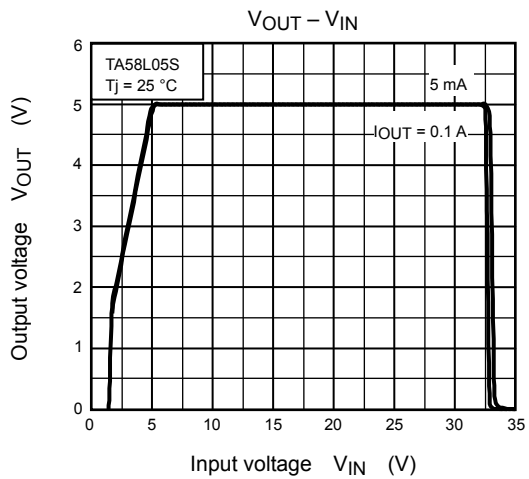
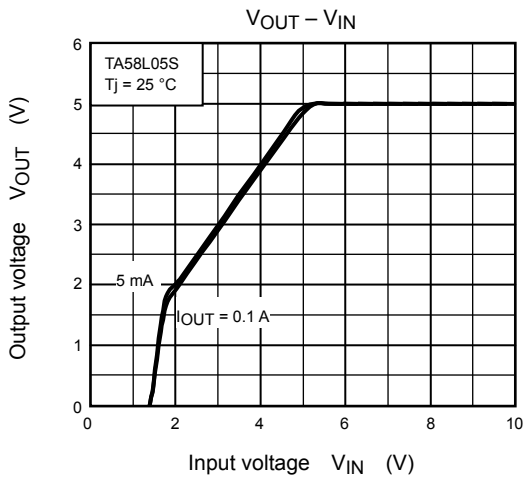
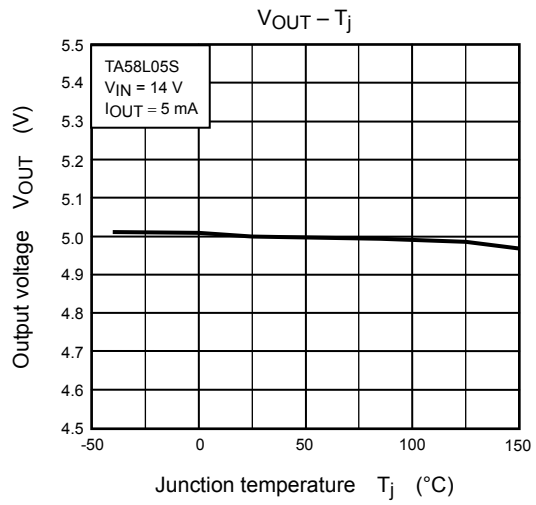
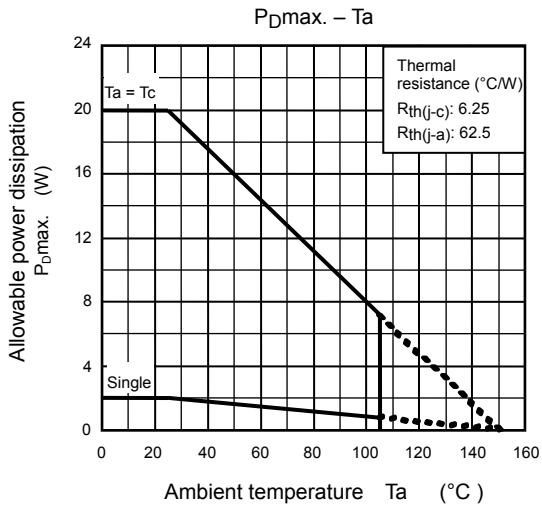

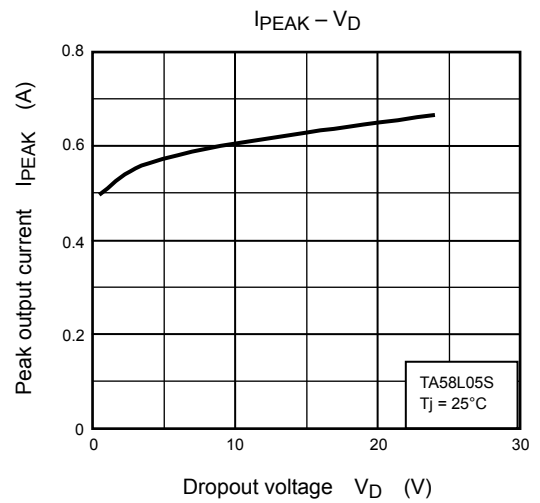
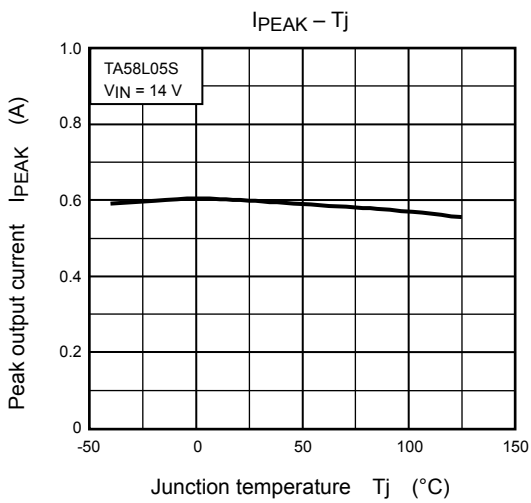
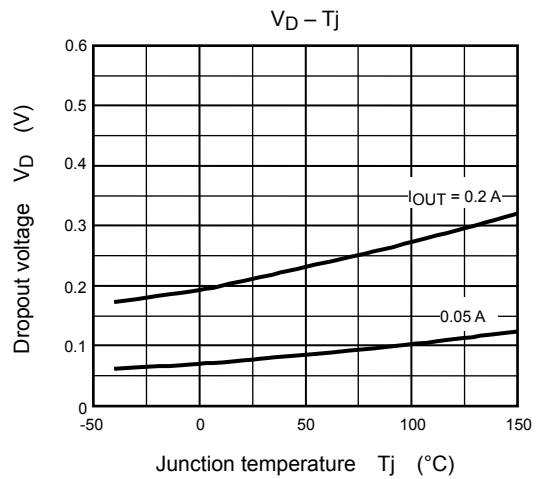
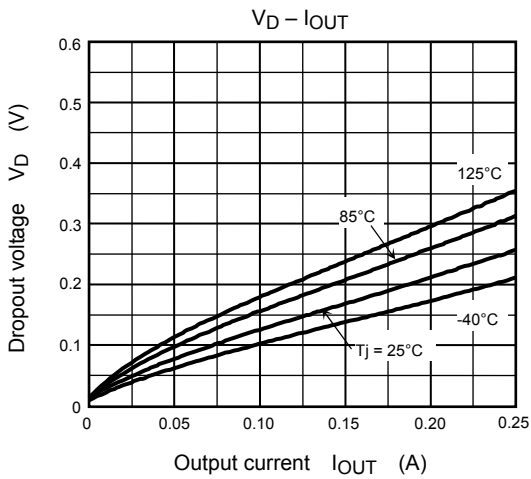
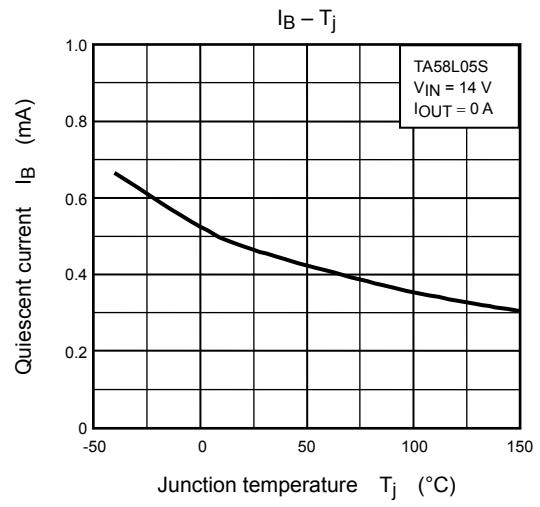
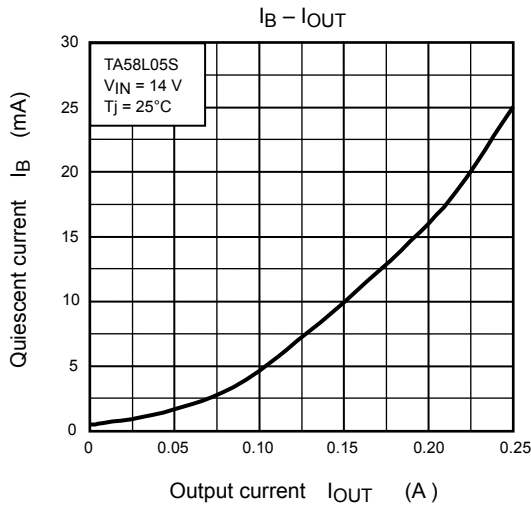

Package Dimensions

HSIP3-P-2.54A

Unit: mm

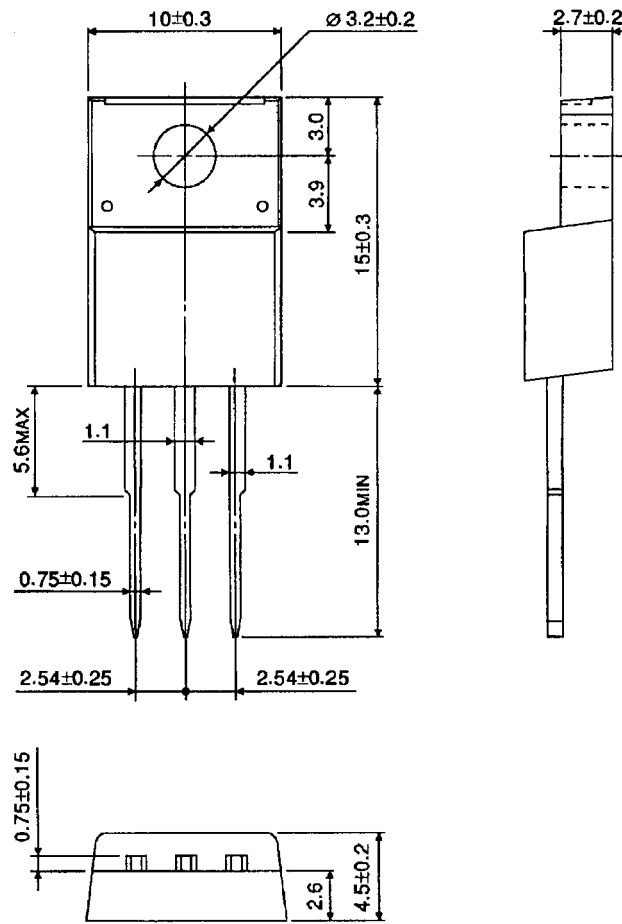

Weight: 1.7 g (typ.)

RESTRICTIONS ON PRODUCT USE

- Toshiba Corporation, and its subsidiaries and affiliates (collectively "TOSHIBA"), reserve the right to make changes to the information in this document, and related hardware, software and systems (collectively "Product") without notice.
- This document and any information herein may not be reproduced without prior written permission from TOSHIBA. Even with TOSHIBA's written permission, reproduction is permissible only if reproduction is without alteration/omission.
- Though TOSHIBA works continually to improve Product's quality and reliability, Product can malfunction or fail. Customers are responsible for complying with safety standards and for providing adequate designs and safeguards for their hardware, software and systems which minimize risk and avoid situations in which a malfunction or failure of Product could cause loss of human life, bodily injury or damage to property, including data loss or corruption. Before customers use the Product, create designs including the Product, or incorporate the Product into their own applications, customers must also refer to and comply with (a) the latest versions of all relevant TOSHIBA information, including without limitation, this document, the specifications, the data sheets and application notes for Product and the precautions and conditions set forth in the "TOSHIBA Semiconductor Reliability Handbook" and (b) the instructions for the application with which the Product will be used with or for. Customers are solely responsible for all aspects of their own product design or applications, including but not limited to (a) determining the appropriateness of the use of this Product in such design or applications; (b) evaluating and determining the applicability of any information contained in this document, or in charts, diagrams, programs, algorithms, sample application circuits, or any other referenced documents; and (c) validating all operating parameters for such designs and applications. **TOSHIBA ASSUMES NO LIABILITY FOR CUSTOMERS' PRODUCT DESIGN OR APPLICATIONS.**
- Product is intended for use in general electronics applications (e.g., computers, personal equipment, office equipment, measuring equipment, industrial robots and home electronics appliances) or for specific applications as expressly stated in this document. Product is neither intended nor warranted for use in equipment or systems that require extraordinarily high levels of quality and/or reliability and/or a malfunction or failure of which may cause loss of human life, bodily injury, serious property damage or serious public impact ("Unintended Use"). Unintended Use includes, without limitation, equipment used in nuclear facilities, equipment used in the aerospace industry, medical equipment, equipment used for automobiles, trains, ships and other transportation, traffic signaling equipment, equipment used to control combustions or explosions, safety devices, elevators and escalators, devices related to electric power, and equipment used in finance-related fields. Do not use Product for Unintended Use unless specifically permitted in this document.
- Do not disassemble, analyze, reverse-engineer, alter, modify, translate or copy Product, whether in whole or in part.
- Product shall not be used for or incorporated into any products or systems whose manufacture, use, or sale is prohibited under any applicable laws or regulations.
- The information contained herein is presented only as guidance for Product use. No responsibility is assumed by TOSHIBA for any infringement of patents or any other intellectual property rights of third parties that may result from the use of Product. No license to any intellectual property right is granted by this document, whether express or implied, by estoppel or otherwise.
- **ABSENT A WRITTEN SIGNED AGREEMENT, EXCEPT AS PROVIDED IN THE RELEVANT TERMS AND CONDITIONS OF SALE FOR PRODUCT, AND TO THE MAXIMUM EXTENT ALLOWABLE BY LAW, TOSHIBA (1) ASSUMES NO LIABILITY WHATSOEVER, INCLUDING WITHOUT LIMITATION, INDIRECT, CONSEQUENTIAL, SPECIAL, OR INCIDENTAL DAMAGES OR LOSS, INCLUDING WITHOUT LIMITATION, LOSS OF PROFITS, LOSS OF OPPORTUNITIES, BUSINESS INTERRUPTION AND LOSS OF DATA, AND (2) DISCLAIMS ANY AND ALL EXPRESS OR IMPLIED WARRANTIES AND CONDITIONS RELATED TO SALE, USE OF PRODUCT, OR INFORMATION, INCLUDING WARRANTIES OR CONDITIONS OF MERCHANTABILITY, FITNESS FOR A PARTICULAR PURPOSE, ACCURACY OF INFORMATION, OR NONINFRINGEMENT.**
- Do not use or otherwise make available Product or related software or technology for any military purposes, including without limitation, for the design, development, use, stockpiling or manufacturing of nuclear, chemical, or biological weapons or missile technology products (mass destruction weapons). Product and related software and technology may be controlled under the Japanese Foreign Exchange and Foreign Trade Law and the U.S. Export Administration Regulations. Export and re-export of Product or related software or technology are strictly prohibited except in compliance with all applicable export laws and regulations.
- Please contact your TOSHIBA sales representative for details as to environmental matters such as the RoHS compatibility of Product. Please use Product in compliance with all applicable laws and regulations that regulate the inclusion or use of controlled substances, including without limitation, the EU RoHS Directive. TOSHIBA assumes no liability for damages or losses occurring as a result of noncompliance with applicable laws and regulations.