

TOSHIBA Bipolar Linear Integrated Circuit Silicon Monolithic

TA78DS05BP, TA78DS06BP, TA78DS08BP, TA78DS09BP, TA78DS10BP, TA78DS12BP, TA78DS15BP, TA78DS05CP

5 V, 6 V, 8 V, 9 V, 10 V, 12 V, 15 V

Low Dropout Voltage Regulator

The TA78DS××BP series consists fixed-positive-output voltage regulator ICs capable of sourcing current up to 30 mA. Due to the features of low dropout voltage and low standby current, these devices are useful for battery-powered equipment. This series includes built-in overcurrent protection, overheating protection, overvoltage protection, input fault protection and excessive transient protection circuits.

Features

- Low standby current of 600 μ A typical.
- Maximum output current of 30 mA.
- Low dropout voltage of less than 0.3 V.
- Multi-protection:
Reverse connection of power supply, 60V load dump, overheating protection and overcurrent protection.
- Available in the plastic TO-92 MOD package.

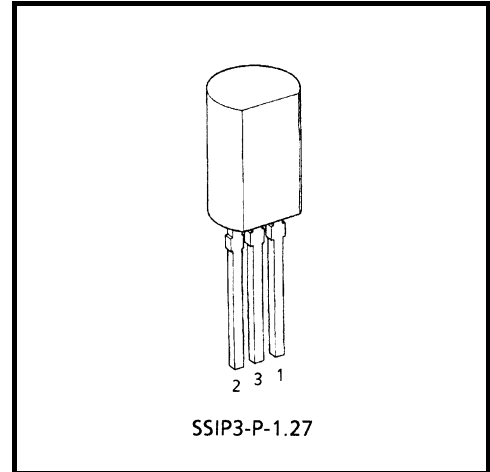

Weight: 0.36 g (Typ.)

Pin Assignment

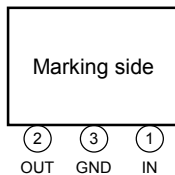

Marking

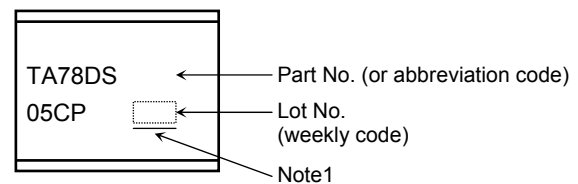
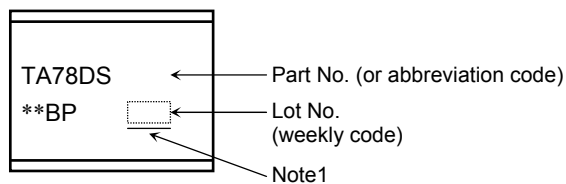

Note 1: A line under a Lot No. identifies the indication of product Labels.

Not underlined: [[Pb]]/INCLUDES > MCV

Underlined: [[G]]/RoHS COMPATIBLE or [[G]]/RoHS [[Pb]]

Please contact your TOSHIBA sales representative for details as to environmental matters such as the RoHS compatibility of Product. The RoHS is the Directive 2002/95/EC of the European Parliament and of the Council of 27 January 2003 on the restriction of the use of certain hazardous substances in electrical and electronic equipment.

The product(s) in this document (“Product”) contain functions intended to protect the Product from temporary small overloads such as minor short-term overcurrent, overvoltage, or overheating. The protective functions do not necessarily protect Product under all circumstances. When incorporating Product into your system, please design the system (1) to avoid such overloads upon the Product, and (2) to shut down or otherwise relieve the Product of such overload conditions immediately upon occurrence. For details, please refer to the notes appearing below in this document and other documents referenced in this document.

Block Diagram

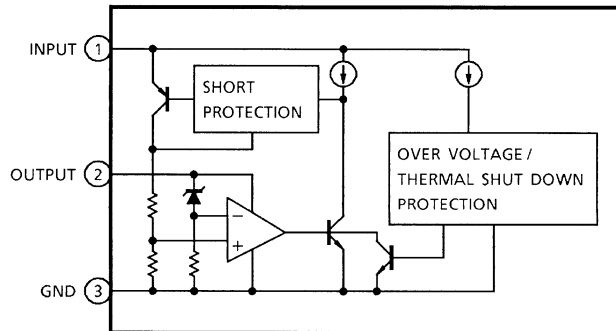

Absolute Maximum Ratings (Ta = 25°C)

Characteristics	Symbol	Rating	Unit
Operating input voltage	V_{IN}	29	V
Input voltage of surge	V_{IN}	60	V
Output current	I_{OUT}	0.03	A
Power dissipation	P_D	800	mW
Operating temperature	T_{opr}	-40 to 85	°C
Storage temperature	T_{stg}	-55 to 150	°C
Junction temperature	T_j	150	°C
Thermal resistance	$R_{th(j-a)}$	156	°C/W
Soldering temperature time	T_{sol}	260 (10 s)	°C

Note: Using continuously under heavy loads (e.g. the application of high temperature/current/voltage and the significant change in temperature, etc.) may cause this product to decrease in the reliability significantly even if the operating conditions (i.e. operating temperature/current/voltage, etc.) are within the absolute maximum ratings and the operating ranges.

Please design the appropriate reliability upon reviewing the Toshiba Semiconductor Reliability Handbook (“Handling Precautions”/“Derating Concept and Methods”) and individual reliability data (i.e. reliability test report and estimated failure rate, etc).

TA78DS05BP

Electrical Characteristics

(Unless otherwise specified, $V_{IN} = 14\text{ V}$, $I_{OUT} = 5\text{ mA}$, $C_{IN} = 0.1\text{ }\mu\text{F}$, $C_{OUT} = 3.3\text{ }\mu\text{F}$, $T_j = 25^\circ\text{C}$)

Characteristics	Symbol	Test Circuit	Test Condition	Min	Typ.	Max	Unit
Output voltage	V_{OUT}	—	$5.35\text{ V} \leq V_{IN} \leq 26\text{ V}$	4.75	5.0	5.25	V
			$5.35\text{ V} \leq V_{IN} \leq 26\text{ V}$, $-40^\circ\text{C} \leq T_a \leq 85^\circ\text{C}$	4.5	5.0	5.5	
Line regulation	Reg-line	—	$9.0\text{ V} \leq V_{IN} \leq 16\text{ V}$	—	1	10	mV
			$6.0\text{ V} \leq V_{IN} \leq 26\text{ V}$	—	4	30	
Load regulation	Reg-load	—	$5.0\text{ mA} \leq I_{OUT} \leq 30\text{ mA}$	—	1	50	mV
Quiescent current	I_B	—	$I_{OUT} = 0\text{ mA}$	—	0.6	1	mA
			$6\text{ V} \leq V_{IN} \leq 26\text{ V}$, $I_{OUT} = 5\text{ mA}$	—	0.7	1	
Dropout voltage	V_D	—	$I_{OUT} = 5\text{ mA}$	—	0.1	0.2	V
			$I_{OUT} = 10\text{ mA}$	—	0.2	0.3	
Max operating voltage	V_{IN}	—	—	29	33	—	V

TA78DS05CP

Electrical Characteristics

(Unless otherwise specified, $V_{IN} = 14\text{ V}$, $I_{OUT} = 5\text{ mA}$, $C_{IN} = 0.1\text{ }\mu\text{F}$, $C_{OUT} = 3.3\text{ }\mu\text{F}$, $T_j = 25^\circ\text{C}$)

Characteristics	Symbol	Test Circuit	Test Condition	Min	Typ.	Max	Unit
Output voltage	V_{OUT}	—	$5.35\text{ V} \leq V_{IN} \leq 26\text{ V}$	4.8	5.0	5.2	V
			$5.35\text{ V} \leq V_{IN} \leq 26\text{ V}$, $-40^\circ\text{C} \leq T_a \leq 85^\circ\text{C}$	4.75	5.0	5.25	
Line regulation	Reg-line	—	$9.0\text{ V} \leq V_{IN} \leq 16\text{ V}$	—	1	10	mV
			$6.0\text{ V} \leq V_{IN} \leq 26\text{ V}$	—	4	30	
Load regulation	Reg-load	—	$5.0\text{ mA} \leq I_{OUT} \leq 30\text{ mA}$	—	1	50	mV
Quiescent current	I_B	—	$I_{OUT} = 0\text{ mA}$	—	0.6	1	mA
			$6\text{ V} \leq V_{IN} \leq 26\text{ V}$, $I_{OUT} = 5\text{ mA}$	—	0.7	1	
Dropout voltage	V_D	—	$I_{OUT} = 5\text{ mA}$	—	0.1	0.2	V
			$I_{OUT} = 10\text{ mA}$	—	0.2	0.3	
Max operating voltage	V_{IN}	—	—	29	33	—	V

TA78DS06BP

Electrical Characteristics

(Unless otherwise specified, $V_{IN} = 14\text{ V}$, $I_{OUT} = 5\text{ mA}$, $C_{IN} = 0.1\text{ }\mu\text{F}$, $C_{OUT} = 3.3\text{ }\mu\text{F}$, $T_j = 25^\circ\text{C}$)

Characteristics	Symbol	Test Circuit	Test Condition	Min	Typ.	Max	Unit
Output voltage	V_{OUT}	—	$6.35\text{ V} \leq V_{IN} \leq 26\text{ V}$	5.7	6.0	6.3	V
			$6.35\text{ V} \leq V_{IN} \leq 26\text{ V}$, $-40^\circ\text{C} \leq T_a \leq 85^\circ\text{C}$	5.4	6.0	6.6	
Line regulation	Reg-line	—	$10\text{ V} \leq V_{IN} \leq 17\text{ V}$	—	1	20	mV
			$7.0\text{ V} \leq V_{IN} \leq 26\text{ V}$	—	4	40	
Load regulation	Reg-load	—	$5.0\text{ mA} \leq I_{OUT} \leq 30\text{ mA}$	—	1	60	mV
Quiescent current	I_B	—	$I_{OUT} = 0\text{ mA}$	—	0.6	1.1	mA
			$7\text{ V} \leq V_{IN} \leq 26\text{ V}$, $I_{OUT} = 5\text{ mA}$	—	0.7	1.1	
Dropout voltage	V_D	—	$I_{OUT} = 5\text{ mA}$	—	0.1	0.2	V
			$I_{OUT} = 10\text{ mA}$	—	0.2	0.3	
Max operating voltage	V_{IN}	—	—	29	33	—	V

TA78DS08BP

Electrical Characteristics

(Unless otherwise specified, $V_{IN} = 14\text{ V}$, $I_{OUT} = 5\text{ mA}$, $C_{IN} = 0.1\text{ }\mu\text{F}$, $C_{OUT} = 3.3\text{ }\mu\text{F}$, $T_j = 25^\circ\text{C}$)

Characteristics	Symbol	Test Circuit	Test Condition	Min	Typ.	Max	Unit
Output voltage	V_{OUT}	—	$8.35\text{ V} \leq V_{IN} \leq 26\text{ V}$	7.6	8.0	8.4	V
			$8.35\text{ V} \leq V_{IN} \leq 26\text{ V}$, $-40^\circ\text{C} \leq T_a \leq 85^\circ\text{C}$	7.2	8.0	8.8	
Line regulation	Reg-line	—	$12\text{ V} \leq V_{IN} \leq 19\text{ V}$	—	2	30	mV
			$9.0\text{ V} \leq V_{IN} \leq 26\text{ V}$	—	5	60	
Load regulation	Reg-load	—	$5.0\text{ mA} \leq I_{OUT} \leq 30\text{ mA}$	—	4	80	mV
Quiescent current	I_B	—	$I_{OUT} = 0\text{ mA}$	—	0.7	1.2	mA
			$9\text{ V} \leq V_{IN} \leq 26\text{ V}$, $I_{OUT} = 5\text{ mA}$	—	0.8	1.2	
Dropout voltage	V_D	—	$I_{OUT} = 5\text{ mA}$	—	0.1	0.2	V
			$I_{OUT} = 10\text{ mA}$	—	0.2	0.3	
Max operating voltage	V_{IN}	—	—	29	33	—	V

TA78DS09BP

Electrical Characteristics

(Unless otherwise specified, $V_{IN} = 14\text{ V}$, $I_{OUT} = 5\text{ mA}$, $C_{IN} = 0.1\text{ }\mu\text{F}$, $C_{OUT} = 3.3\text{ }\mu\text{F}$, $T_j = 25^\circ\text{C}$)

Characteristics	Symbol	Test Circuit	Test Condition	Min	Typ.	Max	Unit
Output voltage	V_{OUT}	—	$9.35\text{ V} \leq V_{IN} \leq 26\text{ V}$	8.55	9.0	9.45	V
			$9.35\text{ V} \leq V_{IN} \leq 26\text{ V}$, $-40^\circ\text{C} \leq T_a \leq 85^\circ\text{C}$	8.1	9.0	9.9	
Line regulation	Reg-line	—	$13\text{ V} \leq V_{IN} \leq 20\text{ V}$	—	2	35	mV
			$10\text{ V} \leq V_{IN} \leq 26\text{ V}$	—	5	70	
Load regulation	Reg-load	—	$5.0\text{ mA} \leq I_{OUT} \leq 30\text{ mA}$	—	4	90	mV
Quiescent current	I_B	—	$I_{OUT} = 0\text{ mA}$	—	0.7	1.3	mA
			$10\text{ V} \leq V_{IN} \leq 26\text{ V}$, $I_{OUT} = 5\text{ mA}$	—	0.8	1.3	
Dropout voltage	V_D	—	$I_{OUT} = 5\text{ mA}$	—	0.1	0.2	V
			$I_{OUT} = 10\text{ mA}$	—	0.2	0.3	
Max operating voltage	V_{IN}	—	—	29	33	—	V

TA78DS10BP

Electrical Characteristics

(Unless otherwise specified, $V_{IN} = 14\text{ V}$, $I_{OUT} = 5\text{ mA}$, $C_{IN} = 0.1\text{ }\mu\text{F}$, $C_{OUT} = 3.3\text{ }\mu\text{F}$, $T_j = 25^\circ\text{C}$)

Characteristics	Symbol	Test Circuit	Test Condition	Min	Typ.	Max	Unit
Output voltage	V_{OUT}	—	$10.35\text{ V} \leq V_{IN} \leq 26\text{ V}$	9.5	10.0	10.5	V
			$10.35\text{ V} \leq V_{IN} \leq 26\text{ V}$, $-40^\circ\text{C} \leq T_a \leq 85^\circ\text{C}$	9.0	10.0	11.0	
Line regulation	Reg-line	—	$14\text{ V} \leq V_{IN} \leq 21\text{ V}$	—	3	40	mV
			$11\text{ V} \leq V_{IN} \leq 26\text{ V}$	—	7	80	
Load regulation	Reg-load	—	$5.0\text{ mA} \leq I_{OUT} \leq 30\text{ mA}$	—	6	100	mV
Quiescent current	I_B	—	$I_{OUT} = 0\text{ mA}$	—	0.7	1.4	mA
			$11\text{ V} \leq V_{IN} \leq 26\text{ V}$, $I_{OUT} = 5\text{ mA}$	—	0.8	1.4	
Dropout voltage	V_D	—	$I_{OUT} = 5\text{ mA}$	—	0.1	0.2	V
			$I_{OUT} = 10\text{ mA}$	—	0.2	0.3	
Max operating voltage	V_{IN}	—	—	29	33	—	V

TA78DS12BP

Electrical Characteristics

(Unless otherwise specified, $V_{IN} = 18\text{ V}$, $I_{OUT} = 5\text{ mA}$, $C_{IN} = 0.1\text{ }\mu\text{F}$, $C_{OUT} = 3.3\text{ }\mu\text{F}$, $T_j = 25^\circ\text{C}$)

Characteristics	Symbol	Test Circuit	Test Condition	Min	Typ.	Max	Unit
Output voltage	V_{OUT}	—	$12.35\text{ V} \leq V_{IN} \leq 26\text{ V}$	11.4	12.0	12.6	V
			$12.35\text{ V} \leq V_{IN} \leq 26\text{ V}$, $-40^\circ\text{C} \leq T_a \leq 85^\circ\text{C}$	10.8	12.0	13.2	
Line regulation	Reg-line	—	$16\text{ V} \leq V_{IN} \leq 23\text{ V}$	—	4	50	mV
			$13\text{ V} \leq V_{IN} \leq 26\text{ V}$	—	8	100	
Load regulation	Reg-load	—	$5.0\text{ mA} \leq I_{OUT} \leq 30\text{ mA}$	—	2	120	mV
Quiescent current	I_B	—	$I_{OUT} = 0\text{ mA}$	—	0.8	1.5	mA
			$13\text{ V} \leq V_{IN} \leq 26\text{ V}$, $I_{OUT} = 5\text{ mA}$	—	1.0	1.5	
Dropout voltage	V_D	—	$I_{OUT} = 5\text{ mA}$	—	0.1	0.2	V
			$I_{OUT} = 10\text{ mA}$	—	0.2	0.3	
Max operating voltage	V_{IN}	—	—	29	33	—	V

TA78DS15BP

Electrical Characteristics

(Unless otherwise specified, $V_{IN} = 20\text{ V}$, $I_{OUT} = 5\text{ mA}$, $C_{IN} = 0.1\text{ }\mu\text{F}$, $C_{OUT} = 3.3\text{ }\mu\text{F}$, $T_j = 25^\circ\text{C}$)

Characteristics	Symbol	Test Circuit	Test Condition	Min	Typ.	Max	Unit
Output voltage	V_{OUT}	—	$15.35\text{ V} \leq V_{IN} \leq 26\text{ V}$	14.25	15.0	15.75	V
			$15.35\text{ V} \leq V_{IN} \leq 26\text{ V}$, $-40^\circ\text{C} \leq T_a \leq 85^\circ\text{C}$	13.5	15.0	16.5	
Line regulation	Reg-line	—	$19\text{ V} \leq V_{IN} \leq 26\text{ V}$	—	5	60	mV
			$16\text{ V} \leq V_{IN} \leq 26\text{ V}$	—	8	130	
Load regulation	Reg-load	—	$5.0\text{ mA} \leq I_{OUT} \leq 30\text{ mA}$	—	1	150	mV
Quiescent current	I_B	—	$I_{OUT} = 0\text{ mA}$	—	1.0	1.6	mA
			$16\text{ V} \leq V_{IN} \leq 26\text{ V}$, $I_{OUT} = 5\text{ mA}$	—	1.2	1.6	
Dropout voltage	V_D	—	$I_{OUT} = 5\text{ mA}$	—	0.1	0.2	V
			$I_{OUT} = 10\text{ mA}$	—	0.2	0.3	
Max operating voltage	V_{IN}	—	—	29	33	—	V

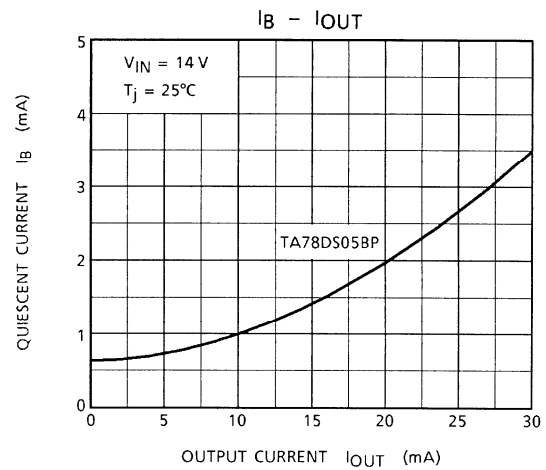
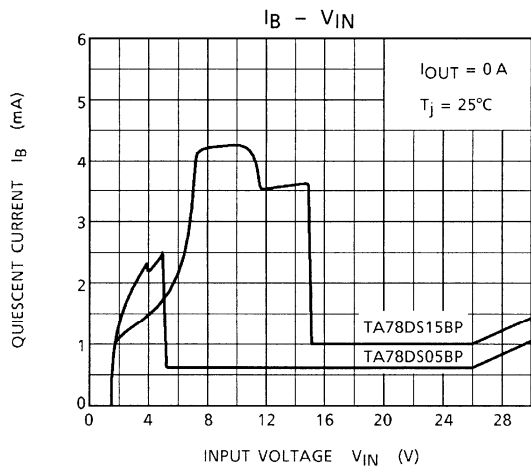
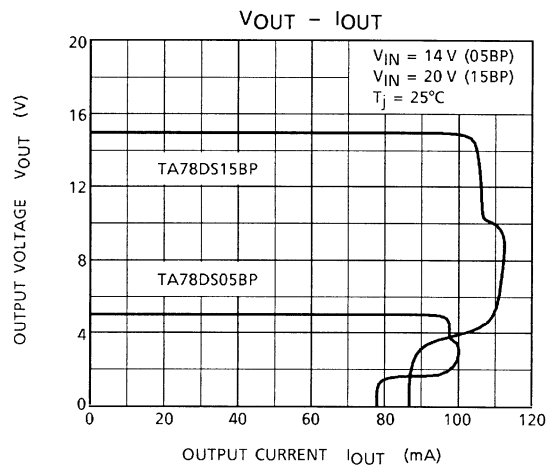
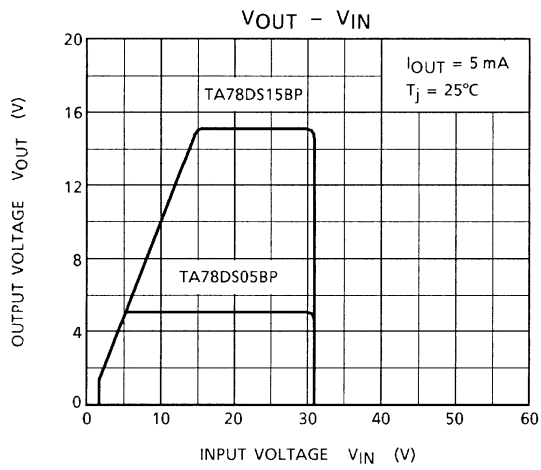
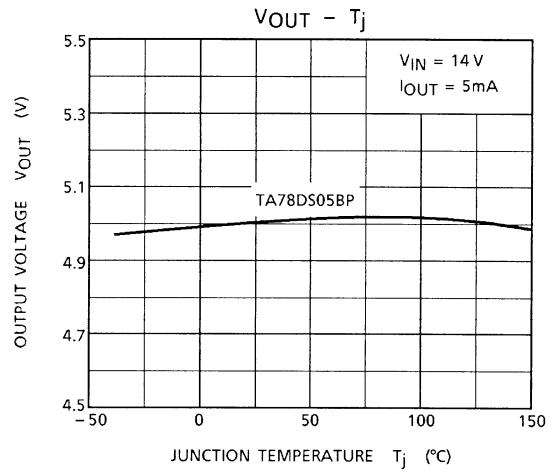
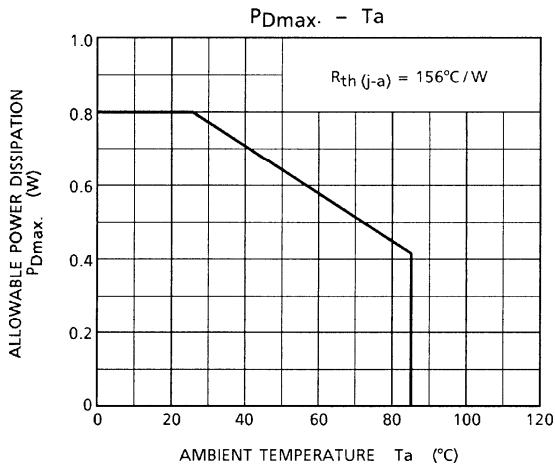

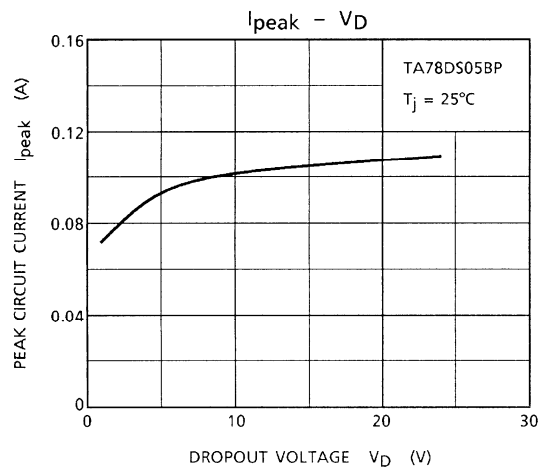
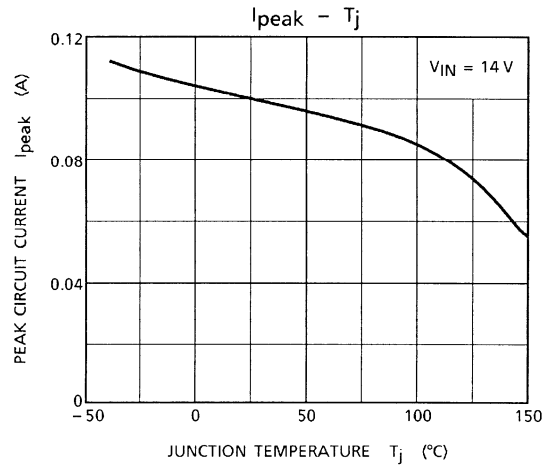
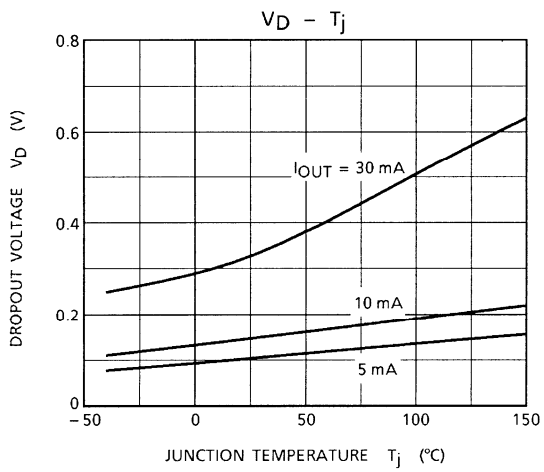
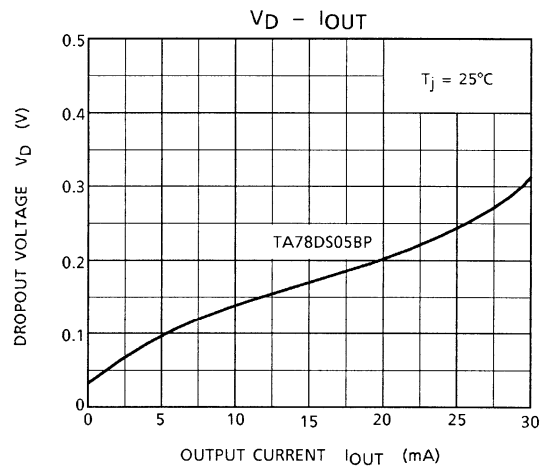
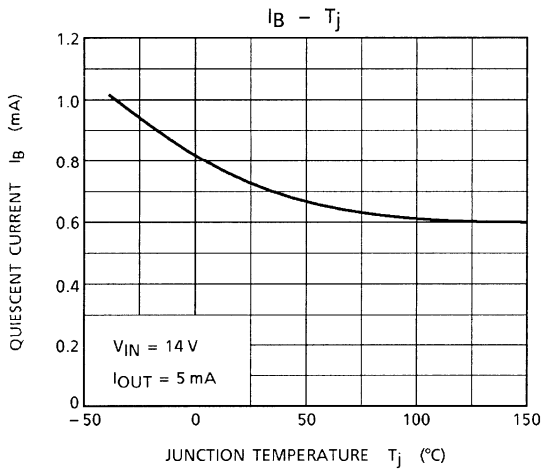

Application Circuit

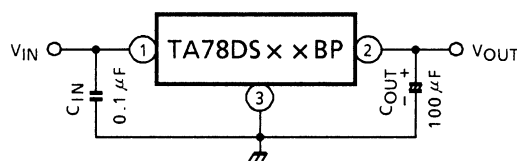

The capacitors C_{IN}/C_{OUT} must be guaranteed to operate within the temperature range in which the regulator operates correctly.

The equivalent series resistance (ESR) of C_{OUT} must be less than 1Ω inside the operating temperature range.

Usage Precautions

- Low voltage

Do not apply voltage to the Product that is lower than the minimum operating voltage, or the Product's protective functions will not operate properly and the Product may be permanently damaged.

- Overcurrent Protection

The overcurrent protection circuits in the Product are designed to temporarily protect Product from minor overcurrent of brief duration. When the overcurrent protective function in the Product activates, immediately cease application of overcurrent to Product. Improper usage of Product, such as application of current to Product exceeding the absolute maximum ratings, could cause the overcurrent protection circuit not to operate properly and/or damage Product permanently even before the protection circuit starts to operate.

- Overheating Protection

The thermal shutdown circuits in the Product are designed to temporarily protect Product from minor overheating of brief duration. When the overheating protective function in the Product activates, immediately correct the overheating situation. Improper usage of Product, such as the application of heat to Product exceeding the absolute maximum ratings, could cause the overheating protection circuit not to operate properly and/or damage Product permanently even before the protection circuit starts to operate.

- Overvoltage Protection

The overvoltage protection circuits in the Product are designed to temporarily protect Product from minor overvoltage of brief duration. When the overvoltage protective function in the Product activates, immediately cease application of overvoltage to Product. Improper usage of Product, such as application of voltage to Product exceeding the absolute maximum ratings, could cause the overvoltage protection circuit not to operate properly and/or damage Product permanently even before the protection circuit starts to operate.

RESTRICTIONS ON PRODUCT USE

- Toshiba Corporation, and its subsidiaries and affiliates (collectively "TOSHIBA"), reserve the right to make changes to the information in this document, and related hardware, software and systems (collectively "Product") without notice.
- This document and any information herein may not be reproduced without prior written permission from TOSHIBA. Even with TOSHIBA's written permission, reproduction is permissible only if reproduction is without alteration/omission.
- Though TOSHIBA works continually to improve Product's quality and reliability, Product can malfunction or fail. Customers are responsible for complying with safety standards and for providing adequate designs and safeguards for their hardware, software and systems which minimize risk and avoid situations in which a malfunction or failure of Product could cause loss of human life, bodily injury or damage to property, including data loss or corruption. Before customers use the Product, create designs including the Product, or incorporate the Product into their own applications, customers must also refer to and comply with (a) the latest versions of all relevant TOSHIBA information, including without limitation, this document, the specifications, the data sheets and application notes for Product and the precautions and conditions set forth in the "TOSHIBA Semiconductor Reliability Handbook" and (b) the instructions for the application with which the Product will be used with or for. Customers are solely responsible for all aspects of their own product design or applications, including but not limited to (a) determining the appropriateness of the use of this Product in such design or applications; (b) evaluating and determining the applicability of any information contained in this document, or in charts, diagrams, programs, algorithms, sample application circuits, or any other referenced documents; and (c) validating all operating parameters for such designs and applications. **TOSHIBA ASSUMES NO LIABILITY FOR CUSTOMERS' PRODUCT DESIGN OR APPLICATIONS.**
- Product is intended for use in general electronics applications (e.g., computers, personal equipment, office equipment, measuring equipment, industrial robots and home electronics appliances) or for specific applications as expressly stated in this document. Product is neither intended nor warranted for use in equipment or systems that require extraordinarily high levels of quality and/or reliability and/or a malfunction or failure of which may cause loss of human life, bodily injury, serious property damage or serious public impact ("Unintended Use"). Unintended Use includes, without limitation, equipment used in nuclear facilities, equipment used in the aerospace industry, medical equipment, equipment used for automobiles, trains, ships and other transportation, traffic signaling equipment, equipment used to control combustions or explosions, safety devices, elevators and escalators, devices related to electric power, and equipment used in finance-related fields. Do not use Product for Unintended Use unless specifically permitted in this document.
- Do not disassemble, analyze, reverse-engineer, alter, modify, translate or copy Product, whether in whole or in part.
- Product shall not be used for or incorporated into any products or systems whose manufacture, use, or sale is prohibited under any applicable laws or regulations.
- The information contained herein is presented only as guidance for Product use. No responsibility is assumed by TOSHIBA for any infringement of patents or any other intellectual property rights of third parties that may result from the use of Product. No license to any intellectual property right is granted by this document, whether express or implied, by estoppel or otherwise.
- **ABSENT A WRITTEN SIGNED AGREEMENT, EXCEPT AS PROVIDED IN THE RELEVANT TERMS AND CONDITIONS OF SALE FOR PRODUCT, AND TO THE MAXIMUM EXTENT ALLOWABLE BY LAW, TOSHIBA (1) ASSUMES NO LIABILITY WHATSOEVER, INCLUDING WITHOUT LIMITATION, INDIRECT, CONSEQUENTIAL, SPECIAL, OR INCIDENTAL DAMAGES OR LOSS, INCLUDING WITHOUT LIMITATION, LOSS OF PROFITS, LOSS OF OPPORTUNITIES, BUSINESS INTERRUPTION AND LOSS OF DATA, AND (2) DISCLAIMS ANY AND ALL EXPRESS OR IMPLIED WARRANTIES AND CONDITIONS RELATED TO SALE, USE OF PRODUCT, OR INFORMATION, INCLUDING WARRANTIES OR CONDITIONS OF MERCHANTABILITY, FITNESS FOR A PARTICULAR PURPOSE, ACCURACY OF INFORMATION, OR NONINFRINGEMENT.**
- Do not use or otherwise make available Product or related software or technology for any military purposes, including without limitation, for the design, development, use, stockpiling or manufacturing of nuclear, chemical, or biological weapons or missile technology products (mass destruction weapons). Product and related software and technology may be controlled under the Japanese Foreign Exchange and Foreign Trade Law and the U.S. Export Administration Regulations. Export and re-export of Product or related software or technology are strictly prohibited except in compliance with all applicable export laws and regulations.
- Please contact your TOSHIBA sales representative for details as to environmental matters such as the RoHS compatibility of Product. Please use Product in compliance with all applicable laws and regulations that regulate the inclusion or use of controlled substances, including without limitation, the EU RoHS Directive. TOSHIBA assumes no liability for damages or losses occurring as a result of noncompliance with applicable laws and regulations.