

300nA NanoPower Voltage References

ISL21080

The ISL21080 analog voltage references feature low supply voltage operation at ultra-low 310nA typ, 1.5µA max operating current. Additionally, the ISL21080 family features guaranteed initial accuracy as low as ±0.2% and 50ppm/°C temperature coefficient.

These references are ideal for general purpose portable applications to extend battery life at lower cost. The ISL21080 is provided in the industry standard 3 Ld SOT-23 pinout.

The ISL21080 output voltages can be used as precision voltage sources for voltage monitors, control loops, standby voltages for low power states for DSP, FPGA, Datapath Controllers, microcontrollers and other core voltages: 0.9V, 1.024V, 1.25V, 1.5V, 2.048V, 2.5V, 3.0V, 3.3V, 4.096V and 5.0V.

Special Note: Post-assembly x-ray inspection may lead to permanent changes in device output voltage and should be minimized or avoided. For further information, please see "Applications Information" on page 14 and [AN1533](#), "X-Ray Effects on Intersil FGA References".

Applications* (see page 20)

- Energy Harvesting Applications
- Wireless Sensor Network Applications
- Low Power Voltage Sources for Controllers, FPGA, ASICs or Logic Devices
- Battery Management/Monitoring
- Low Power Standby Voltages
- Portable Instrumentation
- Consumer/Medical Electronics
- Wearable Electronics
- Lower Cost Industrial and Instrumentation
- Power Regulation Circuits
- Control Loops and Compensation Networks
- LED/Diode Supply

Features

- Reference Output Voltage 0.900V, 1.024V, 1.250V, 1.500V, 2.048V, 2.500V, 3.000V, 3.300V, 4.096V, 5.000V
- Initial Accuracy:
 - ISL21080-09 and -10 ±0.7%
 - ISL21080-12 ±0.6%
 - ISL21080-15 ±0.5%
 - ISL21080-20 and -25 ±0.3%
 - ISL21080-30, -33, -41, and -50 ±0.2%
- Input Voltage Range:
 - ISL21080-09 2.0V to 5.5V
 - ISL21080-10, -12, -15, -20 and -25 2.7V to 5.5V
 - ISL21080-30 3.2V to 5.5V
 - ISL21080-33 3.5V to 5.5V
 - ISL21080-41 4.5V to 8.0V
 - ISL21080-50 5.5V to 8.0V
- Output Voltage Noise 30µV_{p-p} (0.1Hz to 10Hz)
- Supply Current 1.5µA (Max)
- Tempco 50ppm/°C
- Output Current Capability ±7mA
- Operating Temperature Range -40°C to +85°C
- Package 3 Ld SOT-23
- Pb-Free (RoHS compliant)

Related Literature* (see page 20)

- See [AN1494](#), "Reflow and PC Board Assembly Effects on Intersil FGA References"
- See [AN1533](#), "X-Ray Effects on Intersil FGA References"

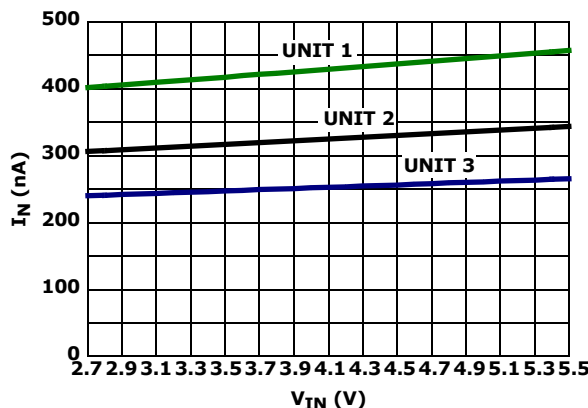
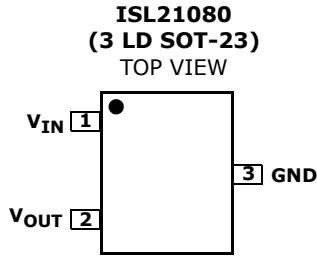

FIGURE 1. I_{IN} vs V_{IN}, 3 UNITS

ISL21080

Pin Configuration



Pin Descriptions

PIN NUMBER	PIN NAME	DESCRIPTION
1	V_{IN}	Input Voltage Connection.
2	V_{OUT}	Voltage Reference Output
3	GND	Ground Connection

Ordering Information

PART NUMBER (Notes 1, 2)	PART MARKING	V_{OUT} OPTION (V)	GRADE (%)	TEMP. RANGE (°C)	PACKAGE Tape & Reel (Pb-Free)	PKG. DWG. #
ISL21080DIH309Z-TK	BCLA	0.9	±0.7	-40 to +85	3 Ld SOT-23	P3.064
ISL21080DIH310Z-TK	BCMA	1.024	±0.7	-40 to +85	3 Ld SOT-23	P3.064
ISL21080DIH312Z-TK	BCNA	1.25	±0.6	-40 to +85	3 Ld SOT-23	P3.064
ISL21080CIH315Z-TK	BCDA	1.5	±0.5	-40 to +85	3 Ld SOT-23	P3.064
ISL21080CIH320Z-TK	BCPA	2.048	±0.3	-40 to +85	3 Ld SOT-23	P3.064
ISL21080CIH325Z-TK	BCRA	2.5	±0.3	-40 to +85	3 Ld SOT-23	P3.064
ISL21080CIH330Z-TK	BCSA	3.0	±0.2	-40 to +85	3 Ld SOT-23	P3.064
ISL21080CIH333Z-TK	BCTA	3.3	±0.2	-40 to +85	3 Ld SOT-23	P3.064
ISL21080CIH341Z-TK	BCVA	4.096	±0.2	-40 to +85	3 Ld SOT-23	P3.064
ISL21080CIH350Z-TK	BCWA	5.0	±0.2	-40 to +85	3 Ld SOT-23	P3.064

NOTES:

1. Please refer to [TB347](#) for details on reel specifications.
2. These Intersil Pb-free plastic packaged products employ special Pb-free material sets, molding compounds/die attach materials, and 100% matte tin plate plus anneal (e3 termination finish, which is RoHS compliant and compatible with both SnPb and Pb-free soldering operations). Intersil Pb-free products are MSL classified at Pb-free peak reflow temperatures that meet or exceed the Pb-free requirements of IPC/JEDEC J STD-020.
3. For Moisture Sensitivity Level (MSL), please see device information page for [ISL21080](#). For more information on MSL please see techbrief [TB363](#).

ISL21080

Absolute Maximum Ratings

Max Voltage	
V_{IN} to GND	-0.5V to +6.5V
V_{IN} to GND (ISL21080-41 and 50 only)	-0.5V to +10V
V_{OUT} to GND (10s)	-0.5V to $V_{OUT} + 1V$
V_{OUT} to GND (10s)	
ISL21080-41 and 50 only	-0.5V to +5.1V
ESD Ratings	
Human Body Model (Tested to JESD22-A114)	5kV
Machine Model (Tested to JESD22-A115)	500V
Charged Device Model (Tested to JESD22-C101)	2kV
Latch Up (Tested per JESD-78B; Class 2, Level A)	100mA

Environmental Operating Conditions

X-Ray Exposure (Note 4) 10mRem

CAUTION: Do not operate at or near the maximum ratings listed for extended periods of time. Exposure to such conditions may adversely impact product reliability and result in failures not covered by warranty.

NOTES:

- Measured with no filtering, distance of 10" from source, intensity set to 55kV and 70mA current, 30s duration. Other exposure levels should be analyzed for Output Voltage drift effects. See "Applications Information" on page 14.
- θ_{JA} is measured with the component mounted on a high effective thermal conductivity test board in free air. See Tech Brief TB379 for details.
- For θ_{JC} , the "case temp" location is taken at the package top center.
- Post-reflow drift for the ISL21080 devices will range from 100 μ V to 1.0mV based on experimental results with devices on FR4 double sided boards. The design engineer must take this into account when considering the reference voltage after assembly.
- Post-assembly x-ray inspection may also lead to permanent changes in device output voltage and should be minimized or avoided. Initial accuracy can change 10mV or more under extreme radiation. Most inspection equipment will not affect the FGA reference voltage, but if x-ray inspection is required, it is advisable to monitor the reference output voltage to verify excessive shift has not occurred.

Thermal Information

Thermal Resistance (Typical, Notes 5, 6)	θ_{JA} ($^{\circ}$ C/W)	θ_{JC} ($^{\circ}$ C/W)
3 Lead SOT-23	275	110
Maximum Junction Temperature	+107 $^{\circ}$ C	
Continuous Power Dissipation ($T_A = +85^{\circ}$ C)	99mW	
Storage Temperature Range	-65 $^{\circ}$ C to +150 $^{\circ}$ C	
Pb-Free Reflow Profile (Note 7)	see link below	
	http://www.intersil.com/pbfree/Pb-FreeReflow.asp	

Recommended Operating Conditions

Temperature	-40 $^{\circ}$ C to +85 $^{\circ}$ C
Supply Voltage	2.7V to 5.5V

Electrical Specifications (ISL21080-09, $V_{OUT} = 0.9V$) $V_{IN} = 3.0V$, $T_A = -40^{\circ}$ C to +85 $^{\circ}$ C, $I_{OUT} = 0$, unless otherwise specified. **Boldface limits apply over the operating temperature range, -40 $^{\circ}$ C to +85 $^{\circ}$ C.**

PARAMETER	DESCRIPTION	CONDITIONS	MIN (Note 12)	TYP	MAX (Note 12)	UNIT
V_{OUT}	Output Voltage			0.9		V
V_{OA}	V_{OUT} Accuracy @ $T_A = +25^{\circ}$ C (Notes 7, 8)		-0.7		+0.7	%
TC V_{OUT}	Output Voltage Temperature Coefficient (Note 9)				50	ppm/ $^{\circ}$ C
V_{IN}	Input Voltage Range		2.0		5.5	V
I_{IN}	Supply Current			0.35	1.5	μ A
$\Delta V_{OUT} / \Delta V_{IN}$	Line Regulation	$2V \leq V_{IN} \leq 5.5V$		30	350	μ V/V
$\Delta V_{OUT} / \Delta I_{OUT}$	Load Regulation	Sourcing: $0mA \leq I_{OUT} \leq 10mA$		6	100	μ V/mA
		Sinking: $-10mA \leq I_{OUT} \leq 0mA$		23	350	μ V/mA
I_{SC}	Short Circuit Current	$T_A = +25^{\circ}$ C, V_{OUT} tied to GND		30		mA
t_R	Turn-on Settling Time	$V_{OUT} = \pm 0.1\%$ with no load		1		ms
	Ripple Rejection	$f = 120Hz$		-40		dB
e_N	Output Voltage Noise	$0.1Hz \leq f \leq 10Hz$		40		μ V _{p-p}
V_N	Broadband Voltage Noise	$10Hz \leq f \leq 1kHz$		10		μ V _{RMS}
	Noise Density	$f = 1kHz$		1.1		μ V/ \sqrt{Hz}
$\Delta V_{OUT} / \Delta T_A$	Thermal Hysteresis (Note 10)	$\Delta T_A = +125^{\circ}$ C		100		ppm
$\Delta V_{OUT} / \Delta t$	Long Term Stability (Note 11)	$T_A = +25^{\circ}$ C		60		ppm

ISL21080

Electrical Specifications (ISL21080-10, $V_{OUT} = 1.024V$) $V_{IN} = 3.0V$, $T_A = -40^{\circ}C$ to $+85^{\circ}C$, $I_{OUT} = 0$, unless otherwise specified. **Boldface limits apply over the operating temperature range, $-40^{\circ}C$ to $+85^{\circ}C$.**

PARAMETER	DESCRIPTION	CONDITIONS	MIN (Note 12)	TYP	MAX (Note 12)	UNIT
V_{OUT}	Output Voltage			1.024		V
V_{OA}	V_{OUT} Accuracy @ $T_A = +25^{\circ}C$ (Notes 7, 8)		-0.7		+0.7	%
TC V_{OUT}	Output Voltage Temperature Coefficient (Note 9)				50	ppm/ $^{\circ}C$
V_{IN}	Input Voltage Range		2.7		5.5	V
I_{IN}	Supply Current			0.31	1.5	μA
$\Delta V_{OUT} / \Delta V_{IN}$	Line Regulation	$2.7V \leq V_{IN} \leq 5.5V$		80	350	$\mu V/V$
$\Delta V_{OUT} / \Delta I_{OUT}$	Load Regulation	Sourcing: $0mA \leq I_{OUT} \leq 7mA$		25	100	$\mu V/mA$
		Sinking: $-7mA \leq I_{OUT} \leq 0mA$		50	350	$\mu V/mA$
I_{SC}	Short Circuit Current	$T_A = +25^{\circ}C$, V_{OUT} tied to GND		50		mA
t_R	Turn-on Settling Time	$V_{OUT} = \pm 0.1\%$ with no load		4		ms
	Ripple Rejection	$f = 120Hz$		-40		dB
e_N	Output Voltage Noise	$0.1Hz \leq f \leq 10Hz$		30		μV_{p-p}
V_N	Broadband Voltage Noise	$10Hz \leq f \leq 1kHz$		52		μV_{RMS}
		Noise Density	$f = 1kHz$	2.2		$\mu V/\sqrt{Hz}$
$\Delta V_{OUT} / \Delta T_A$	Thermal Hysteresis (Note 10)	$\Delta T_A = +165^{\circ}C$		100		ppm
$\Delta V_{OUT} / \Delta t$	Long Term Stability (Note 11)	$T_A = +25^{\circ}C$		50		ppm

Electrical Specifications (ISL21080-12, $V_{OUT} = 1.25V$) $V_{IN} = 3.0V$, $T_A = -40^{\circ}C$ to $+85^{\circ}C$, $I_{OUT} = 0$, unless otherwise specified. **Boldface limits apply over the operating temperature range, $-40^{\circ}C$ to $+85^{\circ}C$.**

PARAMETER	DESCRIPTION	CONDITIONS	MIN (Note 12)	TYP	MAX (Note 12)	UNIT
V_{OUT}	Output Voltage			1.25		V
V_{OA}	V_{OUT} Accuracy @ $T_A = +25^{\circ}C$ (Notes 7, 8)		-0.6		+0.6	%
TC V_{OUT}	Output Voltage Temperature Coefficient (Note 9)				50	ppm/ $^{\circ}C$
V_{IN}	Input Voltage Range		2.7		5.5	V
I_{IN}	Supply Current			0.31	1.5	μA
$\Delta V_{OUT} / \Delta V_{IN}$	Line Regulation	$2.7V \leq V_{IN} \leq 5.5V$		80	350	$\mu V/V$
$\Delta V_{OUT} / \Delta I_{OUT}$	Load Regulation	Sourcing: $0mA \leq I_{OUT} \leq 7mA$		25	100	$\mu V/mA$
		Sinking: $-7mA \leq I_{OUT} \leq 0mA$		50	350	$\mu V/mA$
I_{SC}	Short Circuit Current	$T_A = +25^{\circ}C$, V_{OUT} tied to GND		50		mA
t_R	Turn-on Settling Time	$V_{OUT} = \pm 0.1\%$ with no load		4		ms
	Ripple Rejection	$f = 120Hz$		-40		dB
e_N	Output Voltage Noise	$0.1Hz \leq f \leq 10Hz$		30		μV_{p-p}
V_N	Broadband Voltage Noise	$10Hz \leq f \leq 1kHz$		52		μV_{RMS}
		Noise Density	$f = 1kHz$	1.1		$\mu V/\sqrt{Hz}$
$\Delta V_{OUT} / \Delta T_A$	Thermal Hysteresis (Note 10)	$\Delta T_A = +165^{\circ}C$		100		ppm
$\Delta V_{OUT} / \Delta t$	Long Term Stability (Note 11)	$T_A = +25^{\circ}C$		50		ppm

ISL21080

Electrical Specifications (ISL21080-15, $V_{OUT} = 1.5V$) $V_{IN} = 3.0V$, $T_A = -40^{\circ}C$ to $+85^{\circ}C$, $I_{OUT} = 0$, unless otherwise specified. **Boldface limits apply over the operating temperature range, $-40^{\circ}C$ to $+85^{\circ}C$.**

PARAMETER	DESCRIPTION	CONDITIONS	MIN (Note 12)	TYP	MAX (Note 12)	UNIT
V_{OUT}	Output Voltage			1.5		V
V_{OA}	V_{OUT} Accuracy @ $T_A = +25^{\circ}C$ (Notes 7, 8)		-0.5		+0.5	%
TC V_{OUT}	Output Voltage Temperature Coefficient (Note 9)				50	ppm/ $^{\circ}C$
V_{IN}	Input Voltage Range		2.7		5.5	V
I_{IN}	Supply Current			0.31	1.5	μA
$\Delta V_{OUT} / \Delta V_{IN}$	Line Regulation	$2.7V \leq V_{IN} \leq 5.5V$		80	350	$\mu V/V$
$\Delta V_{OUT} / \Delta I_{OUT}$	Load Regulation	Sourcing: $0mA \leq I_{OUT} \leq 7mA$		10	100	$\mu V/mA$
		Sinking: $-7mA \leq I_{OUT} \leq 0mA$		50	350	$\mu V/mA$
I_{SC}	Short Circuit Current	$T_A = +25^{\circ}C$, V_{OUT} tied to GND		50		mA
t_R	Turn-on Settling Time	$V_{OUT} = \pm 0.1\%$ with no load		4		ms
	Ripple Rejection	$f = 120Hz$		-40		dB
e_N	Output Voltage Noise	$0.1Hz \leq f \leq 10Hz$		30		μV_{P-P}
V_N	Broadband Voltage Noise	$10Hz \leq f \leq 1kHz$		52		μV_{RMS}
		Noise Density	$f = 1kHz$	1.1		$\mu V/\sqrt{Hz}$
$\Delta V_{OUT} / \Delta T_A$	Thermal Hysteresis (Note 10)	$\Delta T_A = +165^{\circ}C$		100		ppm
$\Delta V_{OUT} / \Delta t$	Long Term Stability (Note 11)	$T_A = +25^{\circ}C$		50		ppm

Electrical Specifications (ISL21080-20, $V_{OUT} = 2.048V$) $V_{IN} = 3.0V$, $T_A = -40^{\circ}C$ to $+85^{\circ}C$, $I_{OUT} = 0$, unless otherwise specified. **Boldface limits apply over the operating temperature range, $-40^{\circ}C$ to $+85^{\circ}C$.**

PARAMETER	DESCRIPTION	CONDITIONS	MIN (Note 12)	TYP	MAX (Note 12)	UNIT
V_{OUT}	Output Voltage			2.048		V
V_{OA}	V_{OUT} Accuracy @ $T_A = +25^{\circ}C$ (Notes 7, 8)		-0.3		+0.3	%
TC V_{OUT}	Output Voltage Temperature Coefficient (Note 9)				50	ppm/ $^{\circ}C$
V_{IN}	Input Voltage Range		2.7		5.5	V
I_{IN}	Supply Current			0.31	1.5	μA
$\Delta V_{OUT} / \Delta V_{IN}$	Line Regulation	$2.7V \leq V_{IN} \leq 5.5V$		80	350	$\mu V/V$
$\Delta V_{OUT} / \Delta I_{OUT}$	Load Regulation	Sourcing: $0mA \leq I_{OUT} \leq 7mA$		25	100	$\mu V/mA$
		Sinking: $-7mA \leq I_{OUT} \leq 0mA$		50	350	$\mu V/mA$
I_{SC}	Short Circuit Current	$T_A = +25^{\circ}C$, V_{OUT} tied to GND		50		mA
t_R	Turn-on Settling Time	$V_{OUT} = \pm 0.1\%$ with no load		4		ms
	Ripple Rejection	$f = 120Hz$		-40		dB
e_N	Output Voltage Noise	$0.1Hz \leq f \leq 10Hz$		30		μV_{P-P}
V_N	Broadband Voltage Noise	$10Hz \leq f \leq 1kHz$		52		μV_{RMS}
		Noise Density	$f = 1kHz$	1.1		$\mu V/\sqrt{Hz}$
$\Delta V_{OUT} / \Delta T_A$	Thermal Hysteresis (Note 10)	$\Delta T_A = +165^{\circ}C$		100		ppm
$\Delta V_{OUT} / \Delta t$	Long Term Stability (Note 11)	$T_A = +25^{\circ}C$		50		ppm

ISL21080

Electrical Specifications (ISL21080-25, $V_{OUT} = 2.5V$) $V_{IN} = 3.0V$, $T_A = -40^{\circ}C$ to $+85^{\circ}C$, $I_{OUT} = 0$, unless otherwise specified. **Boldface limits apply over the operating temperature range, $-40^{\circ}C$ to $+85^{\circ}C$.**

PARAMETER	DESCRIPTION	CONDITIONS	MIN (Note 12)	TYP	MAX (Note 12)	UNIT
V_{OUT}	Output Voltage			2.5		V
V_{OA}	V_{OUT} Accuracy @ $T_A = +25^{\circ}C$ (Notes 7, 8)		-0.3		+0.3	%
TC V_{OUT}	Output Voltage Temperature Coefficient (Note 9)				50	ppm/ $^{\circ}C$
V_{IN}	Input Voltage Range		2.7		5.5	V
I_{IN}	Supply Current			0.31	1.5	μA
$\Delta V_{OUT} / \Delta V_{IN}$	Line Regulation	$2.7V \leq V_{IN} \leq 5.5V$		80	350	$\mu V/V$
$\Delta V_{OUT} / \Delta I_{OUT}$	Load Regulation	Sourcing: $0mA \leq I_{OUT} \leq 7mA$		25	100	$\mu V/mA$
		Sinking: $-7mA \leq I_{OUT} \leq 0mA$		50	350	$\mu V/mA$
I_{SC}	Short Circuit Current	$T_A = +25^{\circ}C$, V_{OUT} tied to GND		50		mA
t_R	Turn-on Settling Time	$V_{OUT} = \pm 0.1\%$ with no load		4		ms
	Ripple Rejection	$f = 120Hz$		-40		dB
e_N	Output Voltage Noise	$0.1Hz \leq f \leq 10Hz$		30		μV_{p-p}
V_N	Broadband Voltage Noise	$10Hz \leq f \leq 1kHz$		52		μV_{RMS}
		Noise Density	$f = 1kHz$	1.1		$\mu V/\sqrt{Hz}$
$\Delta V_{OUT} / \Delta T_A$	Thermal Hysteresis (Note 10)	$\Delta T_A = +165^{\circ}C$		100		ppm
$\Delta V_{OUT} / \Delta t$	Long Term Stability (Note 11)	$T_A = +25^{\circ}C$		50		ppm

Electrical Specifications (ISL21080-30, $V_{OUT} = 3.0V$) $V_{IN} = 5.0V$, $T_A = -40^{\circ}C$ to $+85^{\circ}C$, $I_{OUT} = 0$, unless otherwise specified. **Boldface limits apply over the operating temperature range, $-40^{\circ}C$ to $+85^{\circ}C$.**

PARAMETER	DESCRIPTION	CONDITIONS	MIN (Note 12)	TYP	MAX (Note 12)	UNIT
V_{OUT}	Output Voltage			3.0		V
V_{OA}	V_{OUT} Accuracy @ $T_A = +25^{\circ}C$ (Notes 7, 8)		-0.2		+0.2	%
TC V_{OUT}	Output Voltage Temperature Coefficient (Note 9)				50	ppm/ $^{\circ}C$
V_{IN}	Input Voltage Range		3.2		5.5	V
I_{IN}	Supply Current			0.31	1.5	μA
$\Delta V_{OUT} / \Delta V_{IN}$	Line Regulation	$3.2V \leq V_{IN} \leq 5.5V$		80	350	$\mu V/V$
$\Delta V_{OUT} / \Delta I_{OUT}$	Load Regulation	Sourcing: $0mA \leq I_{OUT} \leq 7mA$		25	100	$\mu V/mA$
		Sinking: $-7mA \leq I_{OUT} \leq 0mA$		50	350	$\mu V/mA$
I_{SC}	Short Circuit Current	$T_A = +25^{\circ}C$, V_{OUT} tied to GND		50		mA
t_R	Turn-on Settling Time	$V_{OUT} = \pm 0.1\%$ with no load		4		ms
	Ripple Rejection	$f = 120Hz$		-40		dB
e_N	Output Voltage Noise	$0.1Hz \leq f \leq 10Hz$		30		μV_{p-p}
V_N	Broadband Voltage Noise	$10Hz \leq f \leq 1kHz$		52		μV_{RMS}
		Noise Density	$f = 1kHz$	1.1		$\mu V/\sqrt{Hz}$
$\Delta V_{OUT} / \Delta T_A$	Thermal Hysteresis (Note 10)	$\Delta T_A = +165^{\circ}C$		100		ppm
$\Delta V_{OUT} / \Delta t$	Long Term Stability (Note 11)	$T_A = +25^{\circ}C$		50		ppm

ISL21080

Electrical Specifications (ISL21080-33, $V_{OUT} = 3.3V$) $V_{IN} = 5.0V$, $T_A = -40^{\circ}C$ to $+85^{\circ}C$, $I_{OUT} = 0$, unless otherwise specified. **Boldface limits apply over the operating temperature range, $-40^{\circ}C$ to $+85^{\circ}C$.**

PARAMETER	DESCRIPTION	CONDITIONS	MIN (Note 12)	TYP	MAX (Note 12)	UNIT
V_{OUT}	Output Voltage			3.3		V
V_{OA}	V_{OUT} Accuracy @ $T_A = +25^{\circ}C$ (Notes 7, 8)		-0.2		+0.2	%
TC V_{OUT}	Output Voltage Temperature Coefficient (Note 9)				50	ppm/ $^{\circ}C$
V_{IN}	Input Voltage Range		3.5		5.5	V
I_{IN}	Supply Current			0.31	1.5	μA
$\Delta V_{OUT} / \Delta V_{IN}$	Line Regulation	$3.5 V \leq V_{IN} \leq 5.5V$		80	350	$\mu V/V$
$\Delta V_{OUT} / \Delta I_{OUT}$	Load Regulation	Sourcing: $0mA \leq I_{OUT} \leq 10mA$		25	100	$\mu V/mA$
		Sinking: $-10mA \leq I_{OUT} \leq 0mA$		50	350	$\mu V/mA$
I_{SC}	Short Circuit Current	$T_A = +25^{\circ}C$, V_{OUT} tied to GND		50		mA
t_R	Turn-on Settling Time	$V_{OUT} = \pm 0.1\%$ with no load		4		ms
	Ripple Rejection	$f = 120Hz$		-40		dB
e_N	Output Voltage Noise	$0.1Hz \leq f \leq 10Hz$		30		μV_{P-P}
V_N	Broadband Voltage Noise	$10Hz \leq f \leq 1kHz$		52		μV_{RMS}
	Noise Density	$f = 1kHz$		1.1		$\mu V/\sqrt{Hz}$
$\Delta V_{OUT} / \Delta T_A$	Thermal Hysteresis (Note 10)	$\Delta T_A = +165^{\circ}C$		100		ppm
$\Delta V_{OUT} / \Delta t$	Long Term Stability (Note 11)	$T_A = +25^{\circ}C$		50		ppm

Electrical Specifications (ISL21080-41 $V_{OUT} = 4.096V$) $V_{IN} = 5.0V$, $T_A = -40^{\circ}C$ to $+85^{\circ}C$, $I_{OUT} = 0$, unless otherwise specified. **Boldface limits apply over the operating temperature range, $-40^{\circ}C$ to $+85^{\circ}C$.**

PARAMETER	DESCRIPTION	CONDITIONS	MIN (Note 12)	TYP	MAX (Note 12)	UNIT
V_{OUT}	Output Voltage			4.096		V
V_{OA}	V_{OUT} Accuracy @ $T_A = +25^{\circ}C$ (Notes 7, 8)		-0.2		+0.2	%
TC V_{OUT}	Output Voltage Temperature Coefficient (Note 9)				50	ppm/ $^{\circ}C$
V_{IN}	Input Voltage Range		4.5		8.0	V
I_{IN}	Supply Current			0.5	1.5	μA
$\Delta V_{OUT} / \Delta V_{IN}$	Line Regulation	$4.5 V \leq V_{IN} \leq 8.0V$		80	350	$\mu V/V$
$\Delta V_{OUT} / \Delta I_{OUT}$	Load Regulation	Sourcing: $0mA \leq I_{OUT} \leq 10mA$		10	100	$\mu V/mA$
		Sinking: $-10mA \leq I_{OUT} \leq 0mA$		20	350	$\mu V/mA$
I_{SC}	Short Circuit Current	$T_A = +25^{\circ}C$, V_{OUT} tied to GND		80		mA
t_R	Turn-on Settling Time	$V_{OUT} = \pm 0.1\%$ with no load		4		ms
	Ripple Rejection	$f = 120Hz$		-40		dB
e_N	Output Voltage Noise	$0.1Hz \leq f \leq 10Hz$		30		μV_{P-P}
V_N	Broadband Voltage Noise	$10Hz \leq f \leq 1kHz$		52		μV_{RMS}
	Noise Density	$f = 1kHz$		1.1		$\mu V/\sqrt{Hz}$
$\Delta V_{OUT} / \Delta T_A$	Thermal Hysteresis (Note 10)	$\Delta T_A = +165^{\circ}C$		100		ppm
$\Delta V_{OUT} / \Delta t$	Long Term Stability (Note 11)	$T_A = +25^{\circ}C$		50		ppm

ISL21080

Electrical Specifications (ISL21080-50 $V_{OUT} = 5.0V$) $V_{IN} = 6.5V$, $T_A = -40^{\circ}C$ to $+85^{\circ}C$, $I_{OUT} = 0$, unless otherwise specified. **Boldface limits apply over the operating temperature range, $-40^{\circ}C$ to $+85^{\circ}C$.**

PARAMETER	DESCRIPTION	CONDITIONS	MIN (Note 12)	TYP	MAX (Note 12)	UNIT
V_{OUT}	Output Voltage			5.0		V
V_{OA}	V_{OUT} Accuracy @ $T_A = +25^{\circ}C$ (Notes 7, 8)		-0.2		+0.2	%
TC V_{OUT}	Output Voltage Temperature Coefficient (Note 9)				50	ppm/ $^{\circ}C$
V_{IN}	Input Voltage Range		5.5		8.0	V
I_{IN}	Supply Current			0.5	1.5	μA
$\Delta V_{OUT} / \Delta V_{IN}$	Line Regulation	$5.5 V \leq V_{IN} \leq 8.0V$		80	350	$\mu V/V$
$\Delta V_{OUT} / \Delta I_{OUT}$	Load Regulation	Sourcing: $0mA \leq I_{OUT} \leq 10mA$		10	100	$\mu V/mA$
		Sinking: $-10mA \leq I_{OUT} \leq 0mA$		20	350	$\mu V/mA$
I_{SC}	Short Circuit Current	$T_A = +25^{\circ}C$, V_{OUT} tied to GND		80		mA
t_R	Turn-on Settling Time	$V_{OUT} = \pm 0.1\%$ with no load		4		ms
	Ripple Rejection	$f = 120Hz$		-40		dB
e_N	Output Voltage Noise	$0.1Hz \leq f \leq 10Hz$		30		μV_{P-P}
V_N	Broadband Voltage Noise	$10Hz \leq f \leq 1kHz$		52		μV_{RMS}
		Noise Density	$f = 1kHz$		1.1	$\mu V/\sqrt{Hz}$
$\Delta V_{OUT} / \Delta T_A$	Thermal Hysteresis (Note 10)	$\Delta T_A = +165^{\circ}C$		100		ppm
$\Delta V_{OUT} / \Delta t$	Long Term Stability (Note 11)	$T_A = +25^{\circ}C$		50		ppm

NOTES:

- Over the specified temperature range. Temperature coefficient is measured by the box method whereby the change in V_{OUT} is divided by the temperature range; in this case, $-40^{\circ}C$ to $+85^{\circ}C = +125^{\circ}C$.
- Thermal Hysteresis is the change of V_{OUT} measured @ $T_A = +25^{\circ}C$ after temperature cycling over a specified range, ΔT_A . V_{OUT} is read initially at $T_A = +25^{\circ}C$ for the device under test. The device is temperature cycled and a second V_{OUT} measurement is taken at $+25^{\circ}C$. The difference between the initial V_{OUT} reading and the second V_{OUT} reading is then expressed in ppm. For $\Delta T_A = +125^{\circ}C$, the device under test is cycled from $+25^{\circ}C$ to $+85^{\circ}C$ to $-40^{\circ}C$ to $+25^{\circ}C$.
- Long term drift is logarithmic in nature and diminishes over time. Drift after the first 1000 hours will be approximately $10ppm/\sqrt{1khrs}$.
- Parameters with MIN and/or MAX limits are 100% tested at $+25^{\circ}C$, unless otherwise specified. Temperature limits established by characterization and are not production tested.

Typical Performance Characteristics Curves

$V_{OUT} = 0.9V$, $V_{IN} = 3.0V$, $I_{OUT} = 0mA$, $T_A = +25^{\circ}C$ unless otherwise specified.

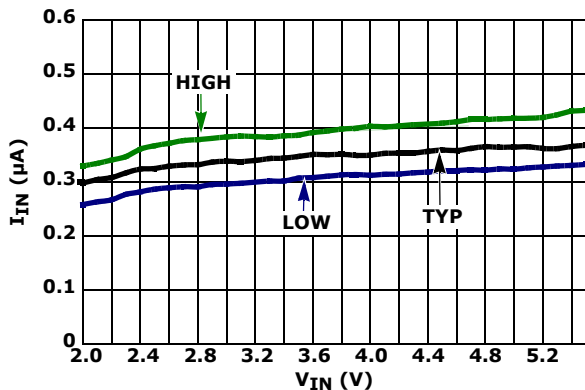

FIGURE 2. I_{IN} vs V_{IN} , 3 UNITS

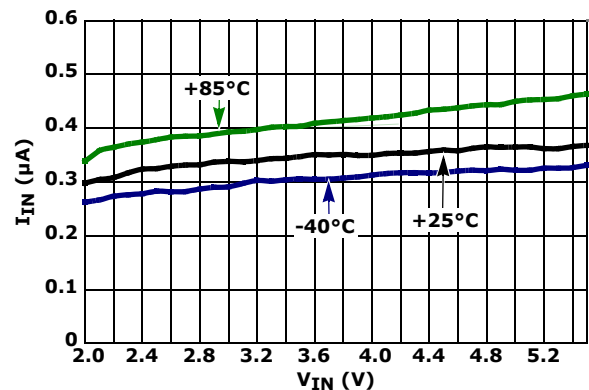

FIGURE 3. I_{IN} vs V_{IN} OVER-TEMPERATURE

Typical Performance Characteristics Curves

$V_{OUT} = 0.9V$, $V_{IN} = 3.0V$, $I_{OUT} = 0mA$,
 $T_A = +25^{\circ}C$ unless otherwise specified.

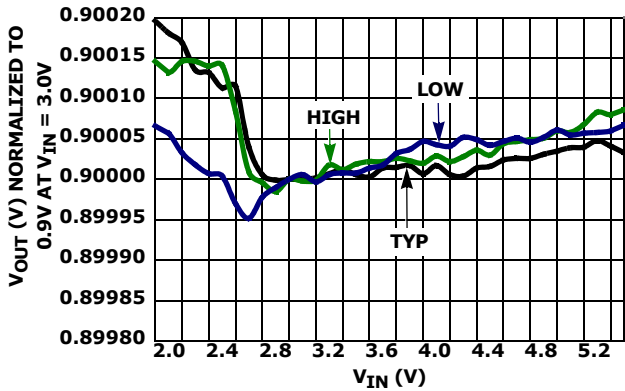

FIGURE 4. LINE REGULATION, 3 UNITS

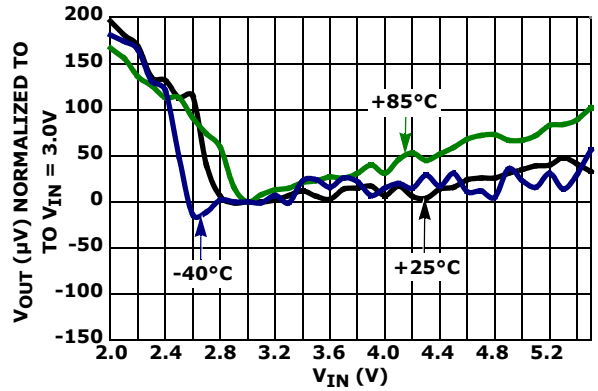

FIGURE 5. LINE REGULATION OVER-TEMPERATURE

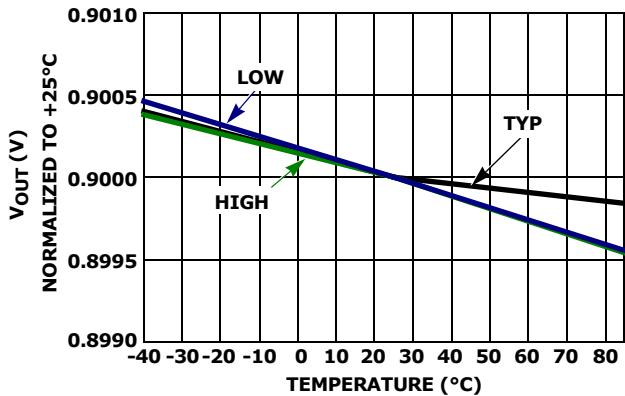

FIGURE 6. V_{OUT} vs TEMPERATURE NORMALIZED TO $+25^{\circ}C$

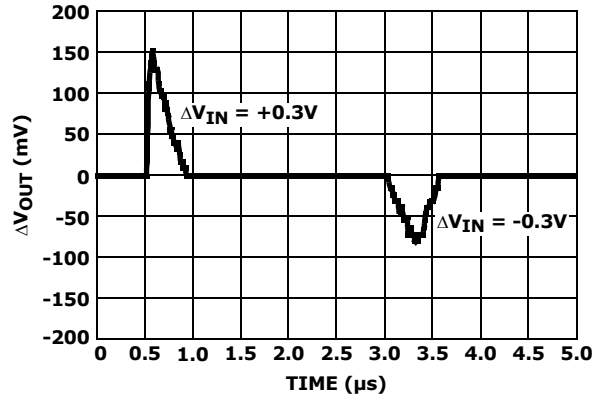

FIGURE 7. LINE TRANSIENT RESPONSE, WITH CAPACITIVE LOAD

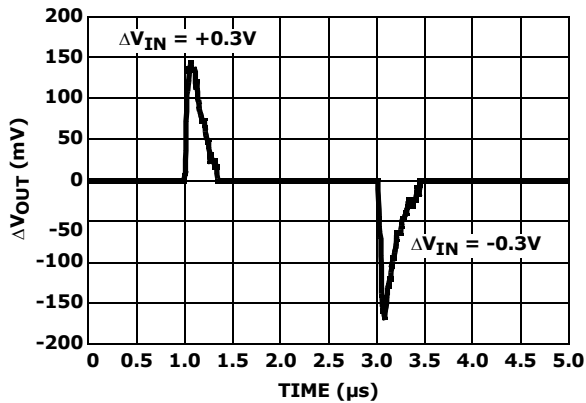

FIGURE 8. LINE TRANSIENT RESPONSE

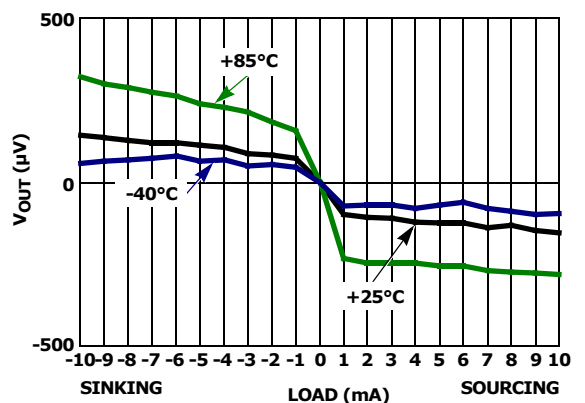

FIGURE 9. LOAD REGULATION OVER-TEMPERATURE

Typical Performance Characteristics Curves

$V_{OUT} = 0.9V$, $V_{IN} = 3.0V$, $I_{OUT} = 0mA$,
 $T_A = +25^{\circ}C$ unless otherwise specified.

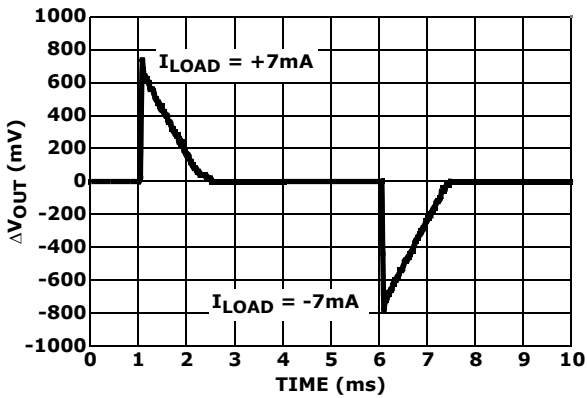

FIGURE 10. LOAD TRANSIENT RESPONSE

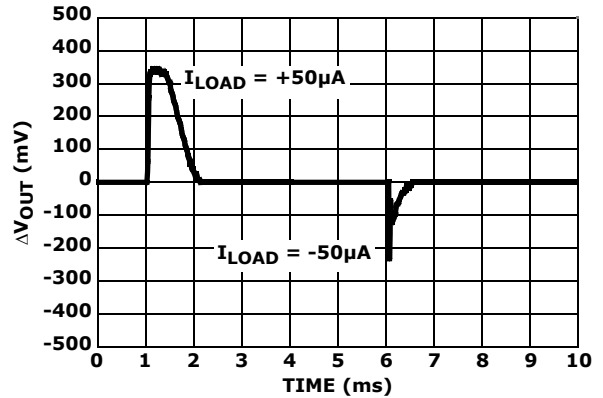

FIGURE 11. LOAD TRANSIENT RESPONSE

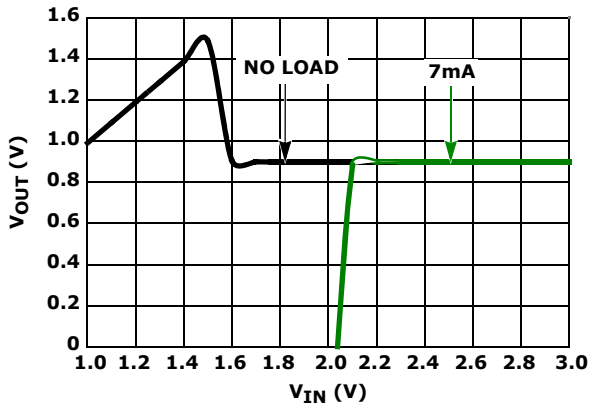

FIGURE 12. DROPOUT

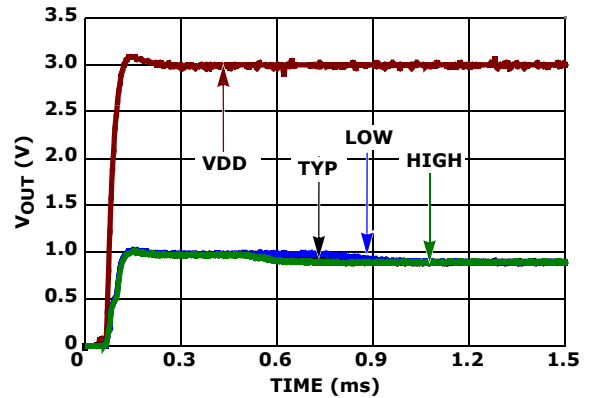

FIGURE 13. TURN-ON TIME

Typical Performance Characteristics Curves

$V_{OUT} = 1.5V$, $V_{IN} = 3.0V$, $I_{OUT} = 0mA$,
 $T_A = +25^{\circ}C$ unless otherwise specified.

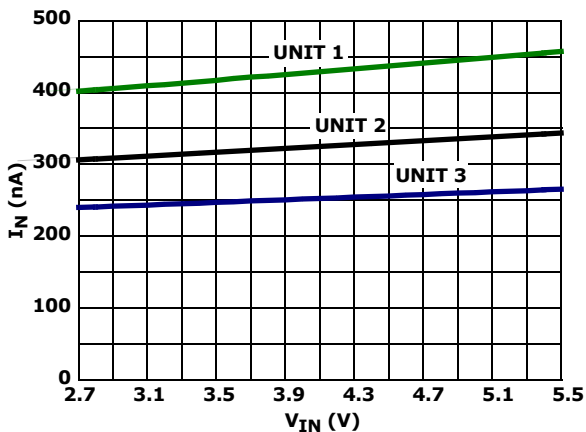

FIGURE 14. I_{IN} vs V_{IN} , 3 UNITS

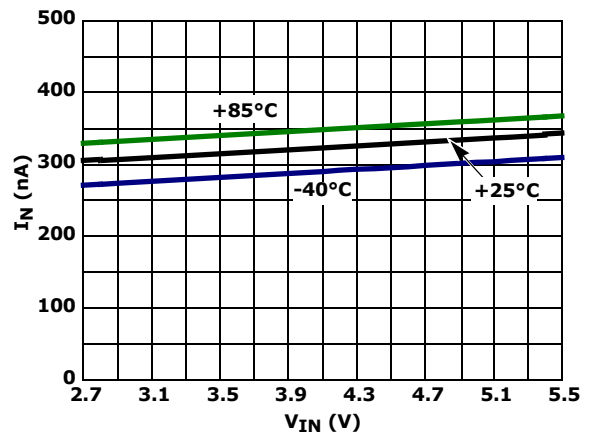

FIGURE 15. I_{IN} vs V_{IN} OVER-TEMPERATURE

Typical Performance Characteristics Curves

$V_{OUT} = 1.5V$, $V_{IN} = 3.0V$, $I_{OUT} = 0mA$,
 $T_A = +25^{\circ}C$ unless otherwise specified.

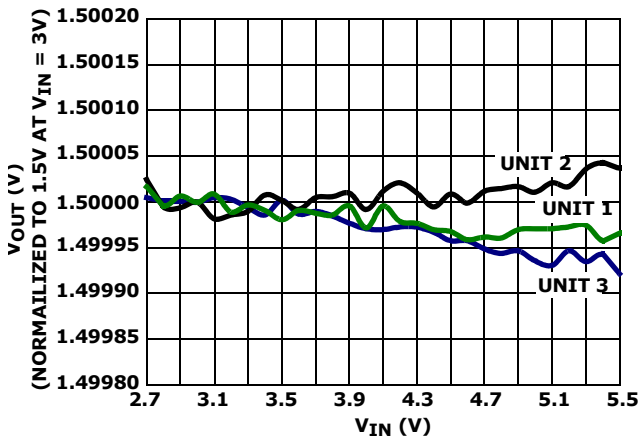

FIGURE 16. LINE REGULATION, 3 UNITS

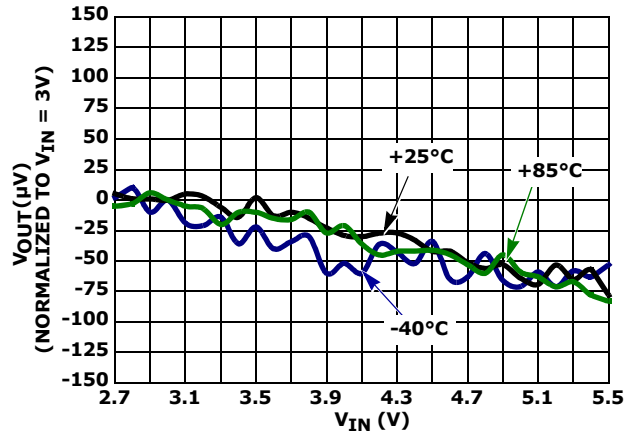

FIGURE 17. LINE REGULATION OVER-TEMPERATURE

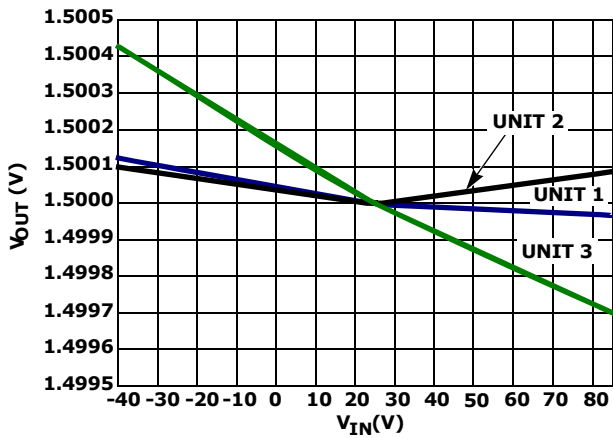

FIGURE 18. V_{OUT} vs TEMPERATURE NORMALIZED to $+25^{\circ}C$

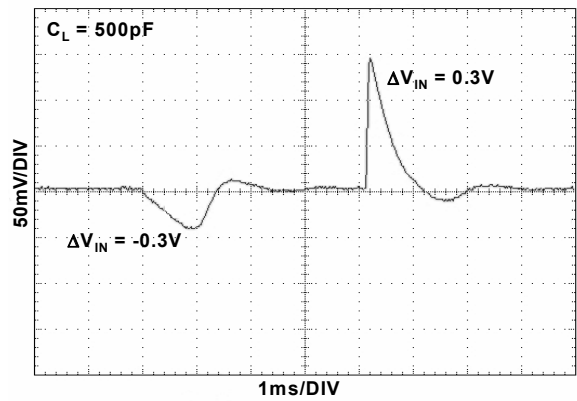

FIGURE 19. LINE TRANSIENT RESPONSE, WITH CAPACITIVE LOAD

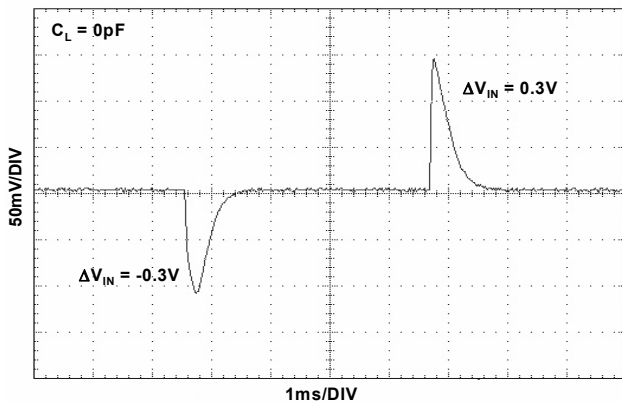

FIGURE 20. LINE TRANSIENT RESPONSE

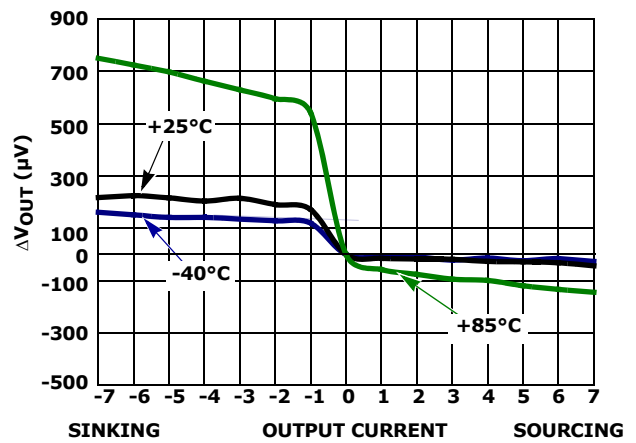

FIGURE 21. LOAD REGULATION OVER-TEMPERATURE

Typical Performance Characteristics Curves

$V_{OUT} = 1.5V$, $V_{IN} = 3.0V$, $I_{OUT} = 0mA$,
 $T_A = +25^{\circ}C$ unless otherwise specified.

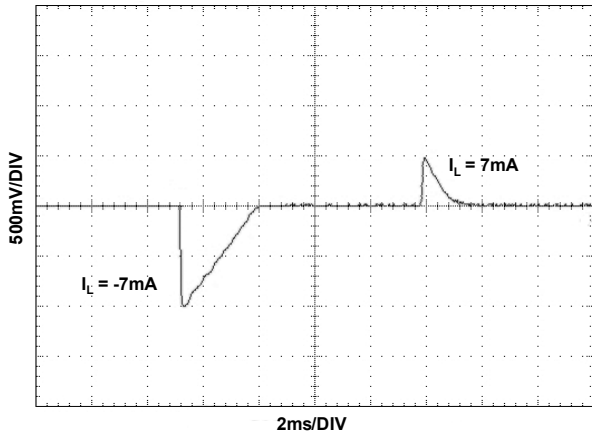

FIGURE 22. LOAD TRANSIENT RESPONSE

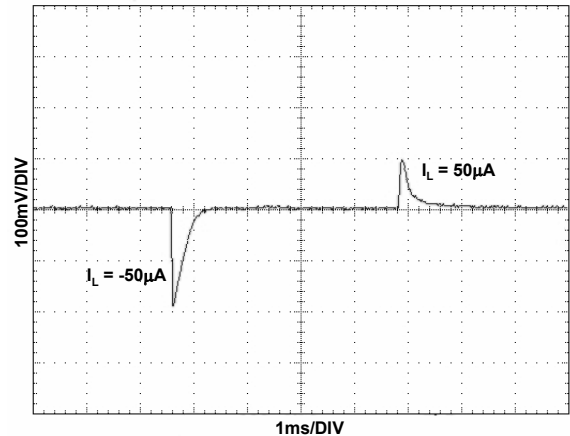

FIGURE 23. LOAD TRANSIENT RESPONSE

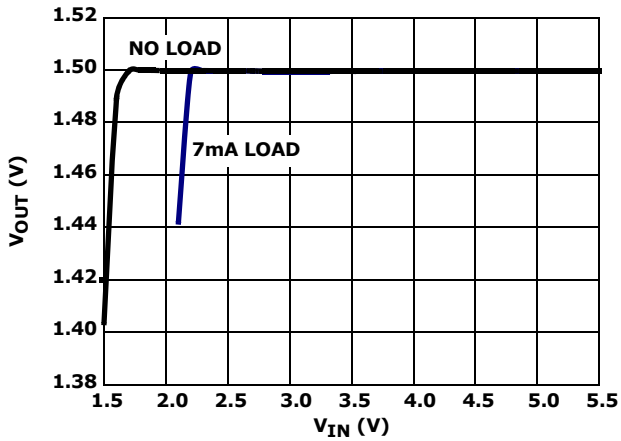

FIGURE 24. DROPOUT

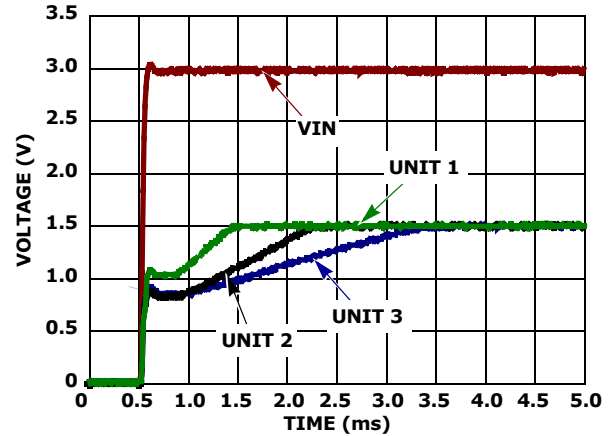

FIGURE 25. TURN-ON TIME

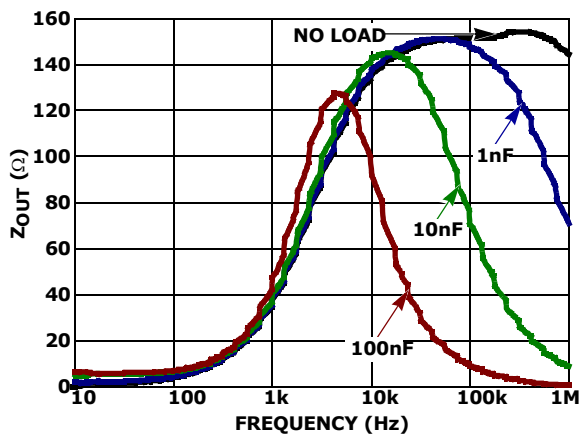

FIGURE 26. ZOUT vs FREQUENCY

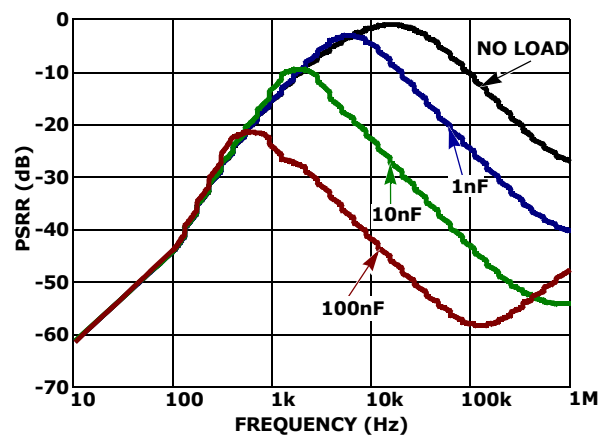

FIGURE 27. PSRR vs FREQUENCY

Typical Performance Characteristics Curves $T_A = +25^\circ\text{C}$ unless otherwise specified.

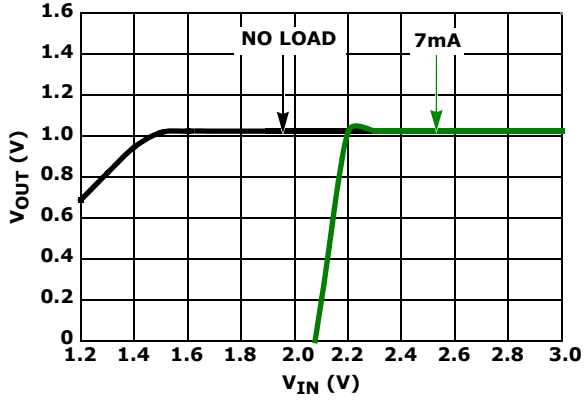

FIGURE 28. DROPOUT, ISL21080-10

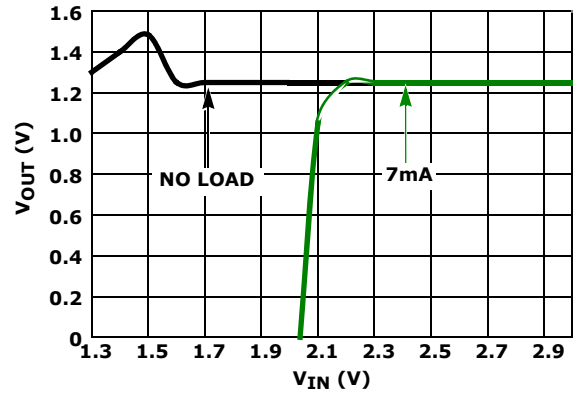

FIGURE 29. DROPOUT, ISL21080-12

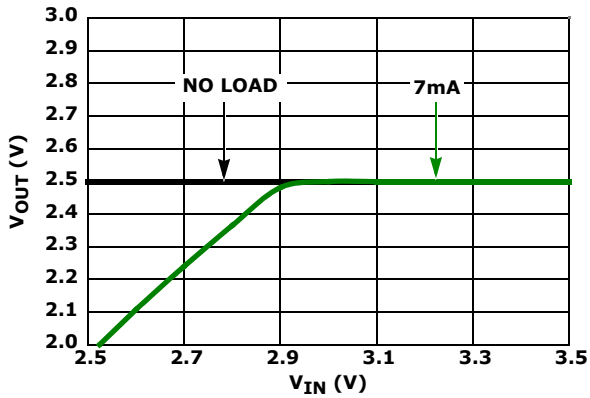

FIGURE 30. DROPOUT, ISL21080-25

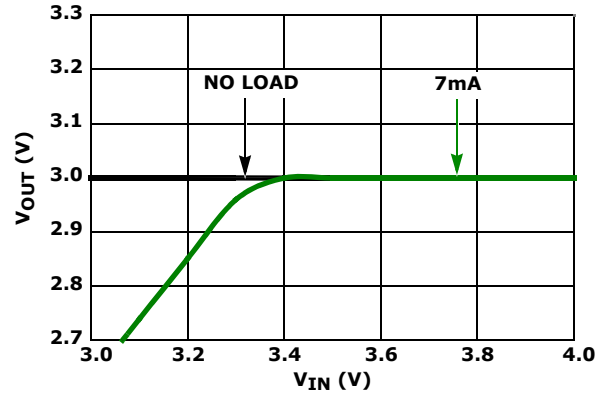

FIGURE 31. DROPOUT, ISL21080-30

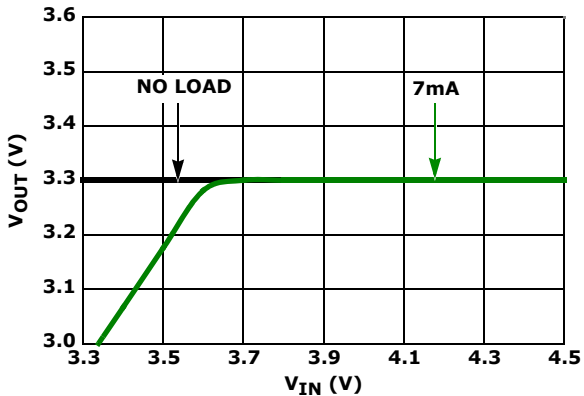

FIGURE 32. DROPOUT, ISL21080-33

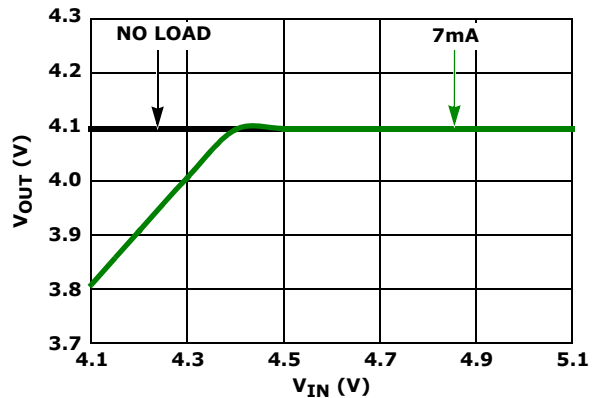

FIGURE 33. DROPOUT, ISL21080-41

Typical Performance Characteristics Curves $T_A = +25^\circ\text{C}$ unless otherwise specified.

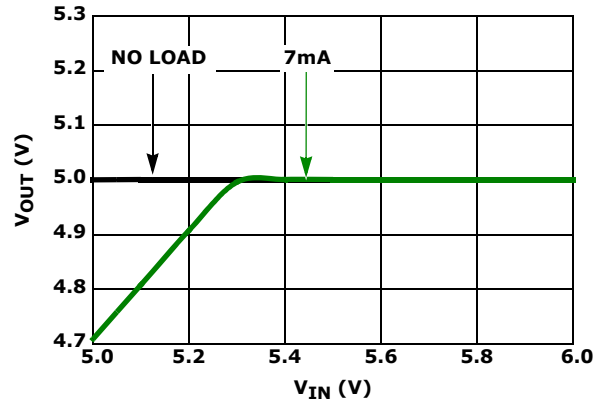

FIGURE 34. DROPOUT, ISL21080-50

High Current Application

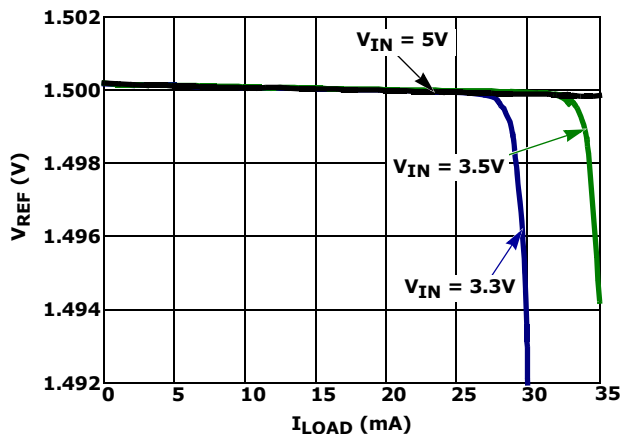

FIGURE 35. DIFFERENT V_{IN} AT ROOM TEMPERATURE

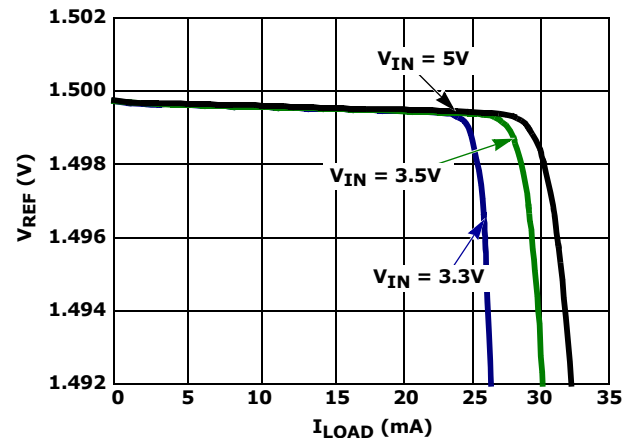

FIGURE 36. DIFFERENT V_{IN} AT HIGH TEMPERATURE (+85°C)

Applications Information

FGA Technology

The ISL21080 series of voltage references use the floating gate technology to create references with very low drift and supply current. Essentially, the charge stored on a floating gate cell is set precisely in manufacturing. The reference voltage output itself is a buffered version of the floating gate voltage. The resulting reference device has excellent characteristics which are unique in the industry: very low temperature drift, high initial accuracy, and almost zero supply current. Also, the reference voltage itself is not limited by voltage bandgaps or zener settings, so a wide range of reference voltages can be programmed (standard voltage settings are provided, but customer-specific voltages are available).

The process used for these reference devices is a floating gate CMOS process, and the amplifier circuitry uses CMOS transistors for amplifier and output transistor circuitry. While providing excellent accuracy, there are limitations in

output noise level and load regulation due to the MOS device characteristics. These limitations are addressed with circuit techniques discussed in other sections.

Board Assembly Considerations

FGA references provide high accuracy and low temperature drift but some PC board assembly precautions are necessary. Normal Output voltage shifts of 100 μV to 1mV can be expected with Pb-free reflow profiles or wave solder on multi-layer FR4 PC boards. Precautions should be taken to avoid excessive heat or extended exposure to high reflow or wave solder temperatures, this may reduce device initial accuracy.

Post-assembly x-ray inspection may also lead to permanent changes in device output voltage and should be minimized or avoided. If x-ray inspection is required, it is advisable to monitor the reference output voltage to verify excessive shift has not occurred. If large amounts of shift are observed, it is best to add an X-ray shield consisting of thin zinc (300 μm) sheeting to allow clear imaging, yet block x-ray energy that affects the FGA reference.

Special Applications Considerations

In addition to post-assembly examination, there are also other X-ray sources that may affect the FGA reference long term accuracy. Airport screening machines contain X-rays and will have a cumulative effect on the voltage reference output accuracy. Carry-on luggage screening uses low level X-rays and is not a major source of output voltage shift, however, if a product is expected to pass through that type of screening over 100 times, it may need to consider shielding with copper or aluminum. Checked luggage X-rays are higher intensity and can cause output voltage shift in much fewer passes, thus devices expected to go through those machines should definitely consider shielding. Note that just two layers of 1/2 ounce copper planes will reduce the received dose by over 90%. The leadframe for the device which is on the bottom also provides similar shielding.

If a device is expected to pass through luggage X-ray machines numerous times, it is advised to mount a 2-layer (minimum) PC board on the top, and along with a ground plane underneath will effectively shield it from from 50 to 100 passes through the machine. Since these machines vary in X-ray dose delivered, it is difficult to produce an accurate maximum pass recommendation.

Nanopower Operation

Reference devices achieve their highest accuracy when powered up continuously, and after initial stabilization has taken place. This drift can be eliminated by leaving the power on continuously.

The ISL21080 is the first high precision voltage reference with ultra low power consumption that makes it possible to leave power on continuously in battery operated circuits. The ISL21080 consumes extremely low supply current due to the proprietary FGA technology. Supply current at room temperature is typically 350nA, which is 1 to 2 orders of magnitude lower than competitive devices. Application circuits using battery power will benefit greatly from having an accurate, stable reference, which essentially presents no load to the battery.

In particular, battery powered data converter circuits that would normally require the entire circuit to be disabled when not in use can remain powered up between conversions as shown in Figure 37. Data acquisition circuits providing 12 bits to 24 bits of accuracy can operate with the reference device continuously biased with no power penalty, providing the highest accuracy and lowest possible long term drift.

Other reference devices consuming higher supply currents will need to be disabled in between conversions to conserve battery capacity. Absolute accuracy will suffer as the device is biased and requires time to settle to its final value, or, may not actually settle to a final value as power on time may be short. Table 1 shows an example of battery life in years for ISL21080 in various power on condition with 1.5µA maximum current consumption.

TABLE 1. EXAMPLE OF BATTERY LIFE IN YEARS FOR ISL21080 IN VARIOUS POWER ON CONDITIONS WITH 1.5µA MAX CURRENT

BATTERY RATING (mAH)	CONTINUOUS	50% DUTY CYCLE	10% DUTY CYCLE
40	3	6	30*
225	16.3*	32.6*	163*

NOTE: *Typical Li-ion battery has a shelf life of up to 10 years.

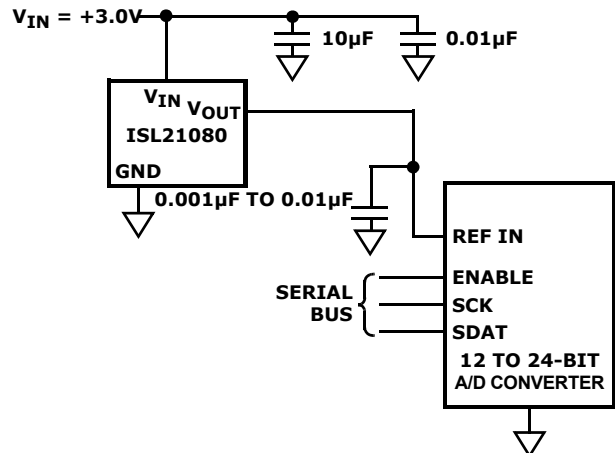

FIGURE 37. REFERENCE INPUT FOR ADC CONVERTER

ISL21080 Used as a Low Cost Precision Current Source

Using an N-JET and a Nanopower voltage reference, ISL21080, a precision, low cost, high impedance current source can be created. The precision of the current source is largely dependent on the tempco and accuracy of the reference. The current setting resistor contributes less than 20% of the error.

Board Mounting Considerations

For applications requiring the highest accuracy, board mounting location should be reviewed. Placing the device in areas subject to slight twisting can cause degradation of the accuracy of the reference voltage due to die stresses. It is normally best to place the device near the edge of a board, or the shortest side, as the axis of bending is most limited at that location. Obviously, mounting the device on flexprint or extremely thin PC material will likewise cause loss of reference accuracy.

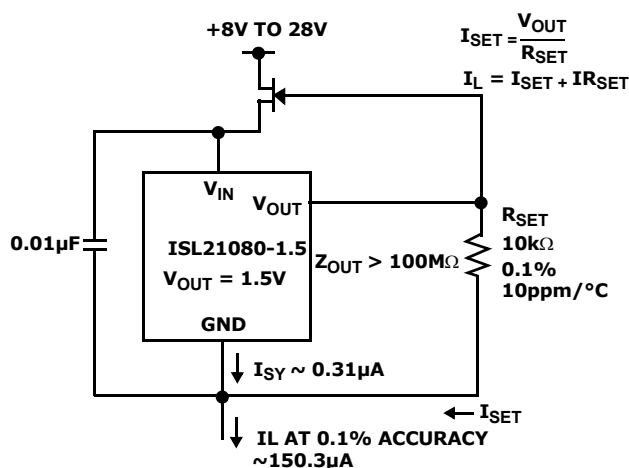

FIGURE 38. ISL21080 USED AS A LOW COST PRECISION CURRENT SOURCE

Noise Performance and Reduction

The output noise voltage in a 0.1Hz to 10Hz bandwidth is typically 30µVp-p. This is shown in the plot in the “Typical Performance Characteristics Curves” which begin on page 10. The noise measurement is made with a bandpass filter made of a 1 pole high-pass filter with a corner frequency at 0.1Hz and a 2-pole low-pass filter with a corner frequency at 12.6Hz to create a filter with a 9.9Hz bandwidth. Noise in the 10kHz to 1MHz bandwidth is approximately 400µVp-p with no capacitance on the output, as shown in Figure 39. These noise measurements are made with a 2 decade bandpass filter made of a 1-pole high-pass filter with a corner frequency at 1/10 of the center frequency and 1-pole low-pass filter with a corner frequency at 10 times the center frequency. Figure 39 also shows the noise in the 10kHz to 1MHz band can be reduced to about 50µVp-p using a 0.001µF capacitor on the output. Noise in the 1kHz to 100kHz band can be further reduced using a 0.1µF capacitor on the output, but noise in the 1Hz to 100Hz band increases due to instability of the very low power amplifier with a 0.1µF capacitance load. For load capacitances above 0.001µF, the noise reduction network shown in Figure 40 is recommended. This network reduces noise significantly over the full bandwidth. As shown in Figure 39, noise is reduced to less than 40µVp-p from 1Hz to 1MHz using this network with a 0.01µF capacitor and a 2kΩ resistor in series with a 10µF capacitor.

Turn-On Time

The ISL21080 devices have ultra-low supply current and thus, the time to bias-up internal circuitry to final values will be longer than with higher power references. Normal turn-on time is typically 7ms. This is shown in Figure 38. Since devices can vary in supply current down to >300nA, turn-on time can last up to about 12ms. Care should be taken in system design to include this delay before measurements or conversions are started.

Temperature Coefficient

The limits stated for temperature coefficient (tempco) are governed by the method of measurement. The overwhelming standard for specifying the temperature drift of a reference, is to measure the reference voltage at two temperatures, take the total variation, (V_{HIGH} - V_{LOW}), and divide by the temperature extremes of measurement (T_{HIGH} - T_{LOW}). The result is divided by the nominal reference voltage (at T = +25°C) and multiplied by 10⁶ to yield ppm/°C. This is the “Box” method for specifying temperature coefficient.

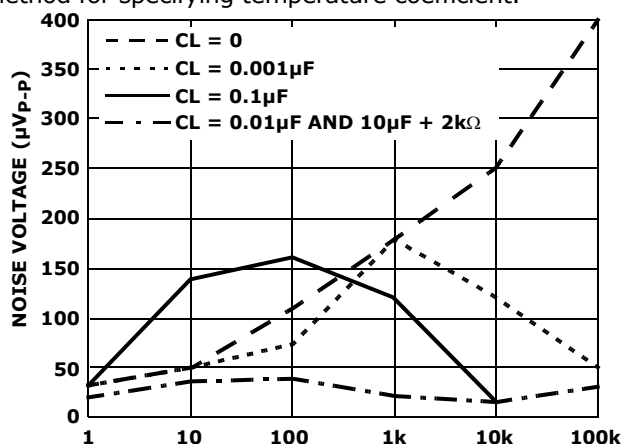

FIGURE 39. NOISE REDUCTION

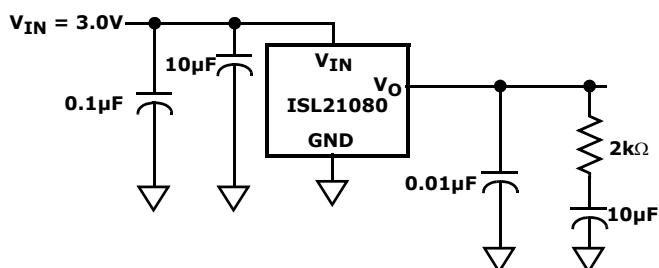

FIGURE 40. NOISE REDUCTION NETWORK

Typical Application Circuits

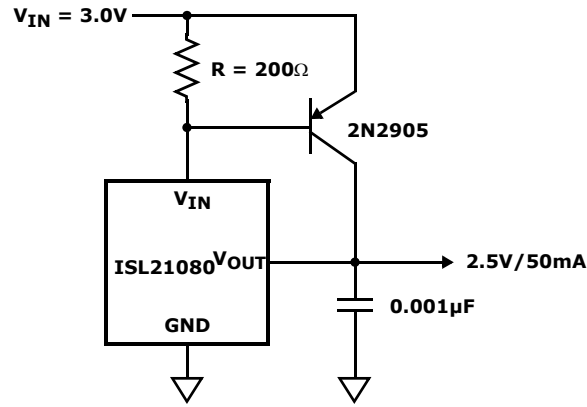

FIGURE 41. PRECISION 2.5V 50mA REFERENCE

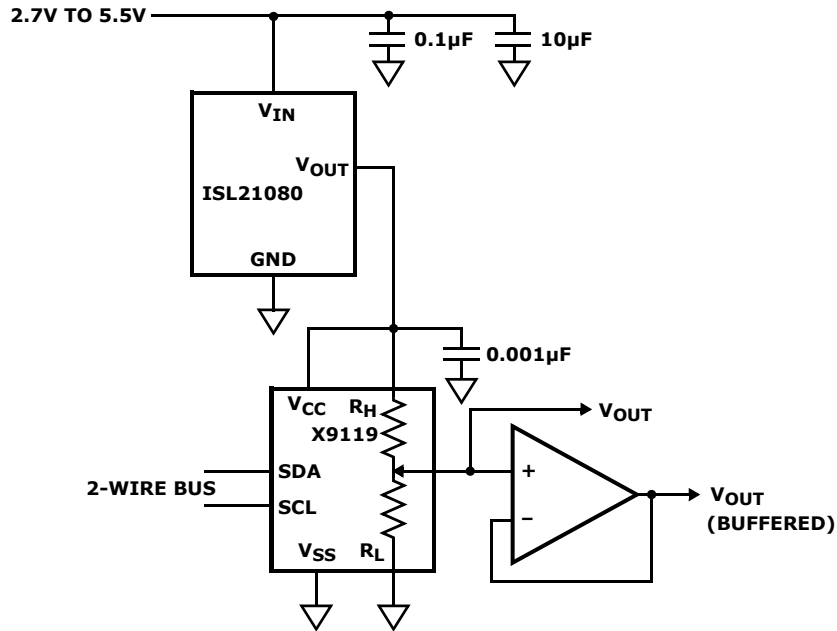

FIGURE 42. 2.5V FULL SCALE LOW-DRIFT 10-BIT ADJUSTABLE VOLTAGE SOURCE

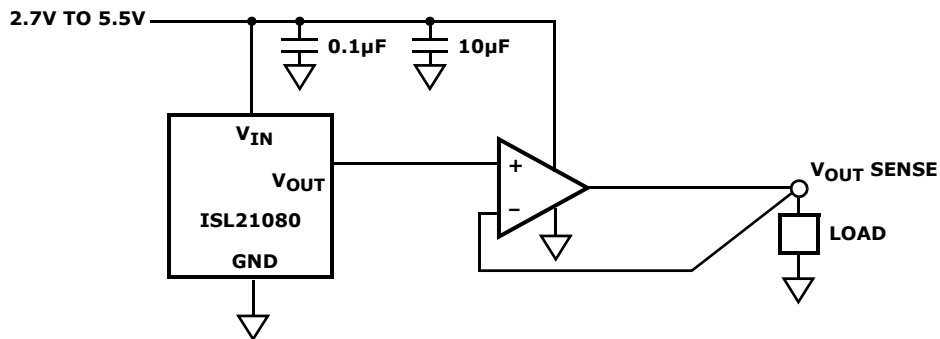

FIGURE 43. KELVIN SENSED LOAD

Revision History

The revision history provided is for informational purposes only and is believed to be accurate, but not warranted. Please go to web to make sure you have the latest Rev.

DATE	REVISION	CHANGE
5/12/10	FN6934.4	Changed Theta JA in the "Thermal Information" on page 3 from 170 to 275. Added Theta JC and applicable note.
4/29/10	FN6934.3	Incorrect Thermal information, needs to be re-evaluated and added at a later date when the final data is available. Removed Theta JC and applicable note from "Thermal Information" on page 3.
4/14/10		Corrected y axis label on Figure 9 from "V _{OUT} (V)" to "V _{OUT} (μV)"
4/6/10		Source/sink for 0.9V option changed from 7mA to 10mA Line regulation condition for 0.9V changed from 2.7V to 2V Line regulation typical for 0.9V option changed from 10 to 30μV/V ΔT _A in Thermal Hysteresis conditions of 0.9V option changed from 165°C to 125°C Moved "Board Assembly Considerations" and "Special Applications Considerations" to page 14. Deleted "Handling and Board Mounting" section since "Board Assembly Considerations" on page 14 contains same discussion. Added "Special Note: Post-assembly x-ray inspection may lead to permanent changes in device output voltage and should be minimized or avoided." to "ISL21080" on page 1 Figures 2 and 3 revised to show line regulation and I _{in} down to 2V. Figures 4 and 5 revised to show V _{in} down to 2V. Added "Initial accuracy can change 10mV or more under extreme radiation." to Note 8 on page 3.
4/1/10		1. page 3: Change V _{in} Min from 2.7 to 2.0 2. page 3: Change I _{in} Typ from 0.31 to 0.35 3. page 3: Change Line Reg Typ from 80 to 10 4. page 3: Change Load Reg Condition from 7mA to 10mA and -7mA to -10mA 5. page 3: Change Load Reg Typ for Source from 25 to 6 and Sink from 50 to 23. 6. page 3: Change I _{sc} Typ from 50 to 30 7. page 3: Change t _R from 4 to 1 8. Change Ripple Rejection typ for all options from -30 to -40 9. page 3: Change e _N typ from 30 to 40V 10. page 3: Change V _N typ from 50 to 10V 11. page 3: Change Noise Density typ from 1.1 to 2.2 12. page 3: Change Long Term Stability from 50 to 60 13. Added Figure 2 to 13 on page 8 to page 10 for 0.9V curves. 14. Added Figure 28 to 34 on page 13 to page 14 for other options Dropout curve. 15. page 1: Change Input Voltage Range for 0.9V option from TBD to 2V to 5.5V 16. Added latch up to "Absolute Maximum Ratings" on page 3 17. Added Junction Temperature to "Thermal Information" on page 3 18. Added JEDEC standards used at the time of testing for "ESD Ratings" on page 3 19. HBM in "Absolute Maximum Ratings" on page 3 changed from 5.5kV to 5kV 20. Added Theta JC and applicable note.
3/25/10		Throughout- Converted to new format. Changes made as follows: Moved "Pin Configuration" and "Pin Descriptions" to page 2 Added "Related Literature*(see page 20)" to page 1 Added key selling feature graphic Figure 1 to page 1 Added "Boldface limits apply..." note to common conditions of Electrical Specifications tables on page 3 through page 8. Bolded applicable specs. Added Note 12 to MIN MAX columns of all Electrical Specifications tables. Added "Environmental Operating Conditions" to page 3 and added Note 4 Added "The process used for these reference devices is a floating gate CMOS process, and the amplifier circuitry uses CMOS transistors for amplifier and output transistor circuitry. While providing excellent accuracy, there are limitations in output noise level and load regulation due to the MOS device characteristics. These limitations are addressed with circuit techniques discussed in other sections." on page 14

Revision History

The revision history provided is for informational purposes only and is believed to be accurate, but not warranted. Please go to web to make sure you have the latest Rev. **(Continued)**

DATE	REVISION	CHANGE
10/14/09	FN6934.2	<p>1. Removed "Coming Soon" on page 1 and 2 for -10, -20, -41, and -50 options.</p> <p>2. Page 1. Moved "ISL21080-50 5.5V to 8.0V" from bullet to sub-bullet.</p> <p>3. Update package outline drawing P3.064 to most recent revision. Updates to package were to add land pattern and move dimensions from table onto drawing (no change to package dimensions)</p>
09/04/09	FN6934.1	<p>Converted to new Intersil template. Added Revision History and Products Information. Updated Ordering Information to match Intrepid, numbered all notes and added Moisture Sensitivity Note with links. Moved Pin Descriptions to page 1 to follow pinout</p> <p>Changed in Features Section</p> <p>From: Reference Output Voltage 1.25V, 1.5V, 2.500V, 3.300V</p> <p>To: Reference Output Voltage 0.900V, 1.024V, 1.250V, 1.500V, 2.048V, 2.500V, 3.000V, 3.300V, 4.096V, 5.000V</p> <p>From: Initial Accuracy: 1.5V ±0.5%</p> <p>To: Initial Accuracy:</p> <p>ISL21080-09 and -10 ±0.7%</p> <p>ISL21080-12 ±0.6%</p> <p>ISL21080-15 ±0.5%</p> <p>ISL21080-20 and -25 ±0.3%</p> <p>ISL21080-30, -33, -41, and -50 ±0.2%</p> <p>FROM: Input Voltage Range</p> <p>ISL21080-12 (Coming Soon) 2.7V to 5.5V</p> <p>ISL21080-15 2.7V to 5.5V</p> <p>ISL21080-25 (Coming Soon) 2.7V to 5.5V</p> <p>ISL21080-33 (Coming Soon) 3.5V to 5.5V</p> <p>TO: Input Voltage Range:</p> <p>ISL21080-09, -10, -12, -15, -20, and -25 2.7V to 5.5V</p> <p>ISL21080-09, -10, and 20 (Coming Soon)</p> <p>ISL21080-30 3.2V to 5.5V</p> <p>ISL21080-33 3.5V to 5.5V</p> <p>ISL21080-41 (Coming Soon) 4.5V to 8.0V</p> <p>Added: ISL21080-50 (Coming Soon) 5.5V to 8.0V Output Voltage Noise 30µVP-P (0.1Hz to 10Hz)</p> <p>Updated Electrical Spec Tables by Tables with Voltage References 9, 10, 12, 20, 25, 30, 33 and 41.</p> <p>Added to Abs Max Ratings:</p> <p>VIN to GND (ISL21080-41 and 50 only) -0.5V to +10V</p> <p>VOUT to GND (10s) (ISL21080-41 and 50 only) -0.5V to +5.1V</p> <p>Changed T_{ja} in Thermal information from "202.70" to "170" to match ASYD in Intrepid</p> <p>Added Note:</p> <p>Post-assembly x-ray inspection may also lead to permanent changes in device output voltage and should be minimized or avoided. Most inspection equipment will not affect the FGA reference voltage, but if x-ray inspection is required, it is advisable to monitor the reference output voltage to verify excessive shift has not occurred.</p> <p>Added Special Applications Considerations Section on page 12.</p>
07/28/09	FN6934.0	Initial Release.

Products

Intersil Corporation is a leader in the design and manufacture of high-performance analog semiconductors. The Company's products address some of the industry's fastest growing markets, such as, flat panel displays, cell phones, handheld products, and notebooks. Intersil's product families address power management and analog signal processing functions. Go to www.intersil.com/products for a complete list of Intersil product families.

*For a complete listing of Applications, Related Documentation and Related Parts, please see the respective device information page on intersil.com: [ISL21080](http://www.intersil.com/ISL21080)

To report errors or suggestions for this datasheet, please go to www.intersil.com/askourstaff

FITs are available from our website at <http://rel.intersil.com/reports/search.php>

For additional products, see www.intersil.com/product_tree

Intersil products are manufactured, assembled and tested utilizing ISO9000 quality systems as noted in the quality certifications found at www.intersil.com/design/quality

Intersil products are sold by description only. Intersil Corporation reserves the right to make changes in circuit design, software and/or specifications at any time without notice. Accordingly, the reader is cautioned to verify that data sheets are current before placing orders. Information furnished by Intersil is believed to be accurate and reliable. However, no responsibility is assumed by Intersil or its subsidiaries for its use; nor for any infringements of patents or other rights of third parties which may result from its use. No license is granted by implication or otherwise under any patent or patent rights of Intersil or its subsidiaries.

For information regarding Intersil Corporation and its products, see www.intersil.com

Package Outline Drawing

P3.064

3 LEAD SMALL OUTLINE TRANSISTOR PLASTIC PACKAGE (SOT23-3)

Rev 2, 9/09

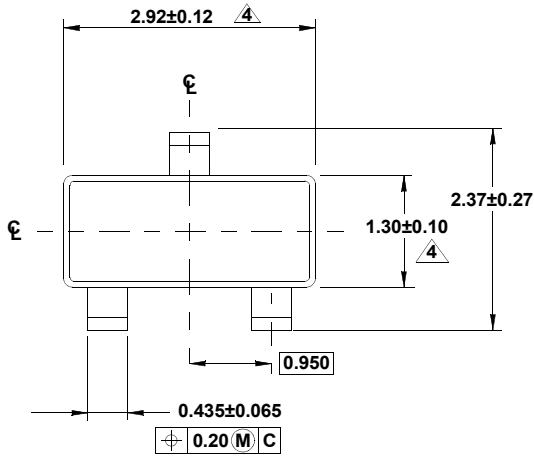

TOP VIEW

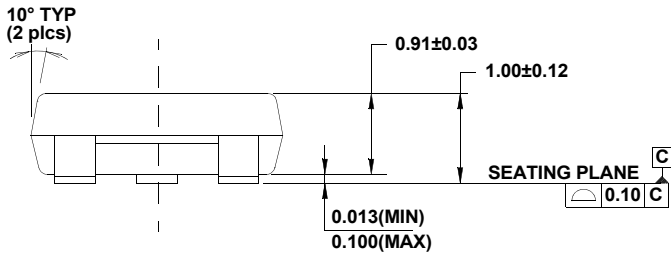
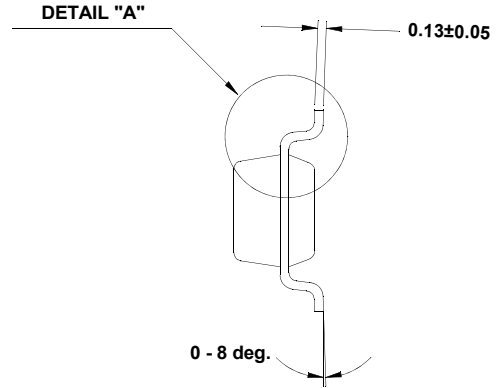

SIDE VIEW

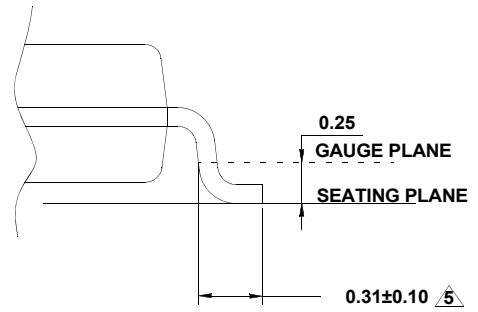

DETAIL "A"

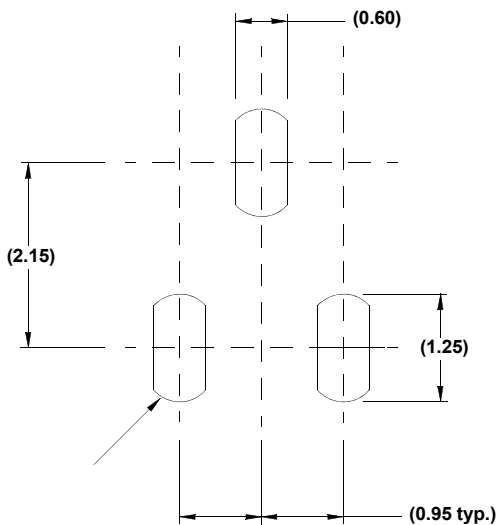

TYPICAL RECOMMENDED LAND PATTERN

NOTES:

1. Dimensions are in millimeters. Dimensions in () for Reference Only.
2. Dimensioning and tolerancing conform to AMSEY14.5m-1994.
3. Reference JEDEC TO-236.
4. Dimension does not include interlead flash or protrusions. Interlead flash or protrusions shall not exceed 0.25mm per side.
5. Footlength is measured at reference to gauge plane.