

HIGH VOLTAGE SWITCHING.  
POWER SUPPLY SWITCHING FOR TELEPHONES.

#### FEATURES

- High Voltage :  $V_{CEO} = -600V$ .
- High Speed Switching Time.  
:  $t_r \leq 1.0\mu s$  ( $I_C = -0.5A$ )
- Low Collector Emitter Saturation Voltage.  
:  $V_{CE(sat)} = -0.28V$  ( $I_C = -0.3A, I_B = -60mA$ )
- Wide Safe Operating Area (SOA).

#### MAXIMUM RATING (Ta=25°C)

CHARACTERISTIC		SYMBOL	RATING	UNIT
Collector-Base Voltage		$V_{CBO}$	-600	V
Collector-Emitter Voltage		$V_{CEO}$	-600	V
Emitter-Base Voltage		$V_{EBO}$	-7	V
Collector Current	DC	$I_C$	-1.0	A
	Pulse *	$I_{CP}$	-2.0	
Collector Power Dissipation		$P_C$	1.0	W
Junction Temperature		$T_j$	150	°C
Storage Temperature Range		$T_{stg}$	-55 ~ 150	°C

\*  $PW \leq 10ms$ , Duty Cycle  $\leq 50\%$ .

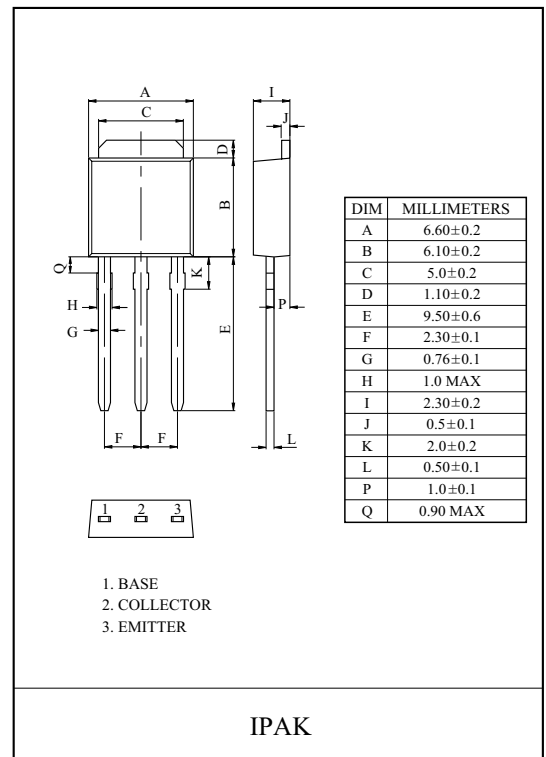
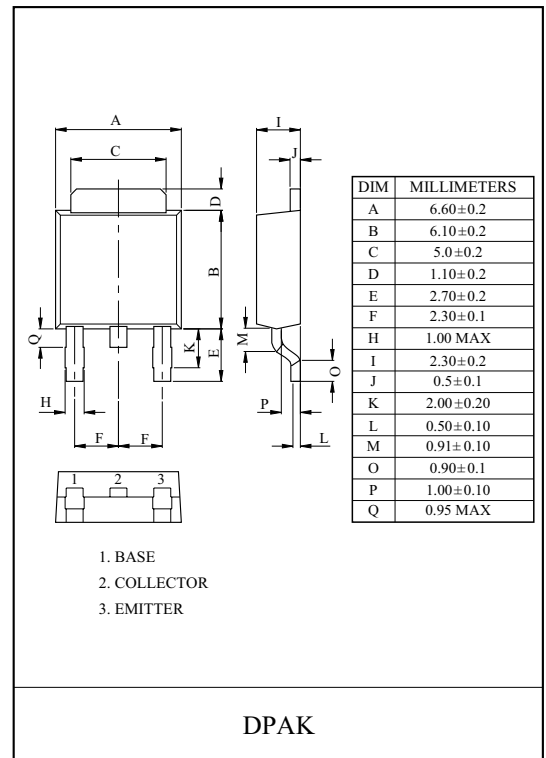

# KTA1807D/L

## ELECTRICAL CHARACTERISTICS (Ta=25 °C)

CHARACTERISTIC		SYMBOL	TEST CONDITION	MIN.	TYP.	MAX.	UNIT
Collector Cut-off Current		$I_{CBO}$	$V_{CB}=-600V, I_E=0$	-	-	-10	$\mu A$
Emitter Cut-off Current		$I_{EBO}$	$V_{EB}=-7.0V, I_C=0$	-	-	-10	$\mu A$
DC Current Gain	$h_{FE}(1)$ (Note)		$V_{CE}=-5.0V, I_C=-0.1A$	30	-	120	
	$h_{FE}(2)$		$V_{CE}=-5.0V, I_C=-0.5A$	5	-	-	
Collector-Emitter Saturation Voltage		$V_{CE(sat)}$	$I_C=-0.3A, I_B=-60mA$	-	-0.28	-1.0	V
Base-Emitter Saturation Voltage		$V_{BE(sat)}$	$I_C=-0.3A, I_B=-60mA$	-	-0.85	-1.2	V
Gain-Bandwidth Product		$f_T$	$V_{CE}=-10V, I_E=50mA$	-	28	-	MHz
Collector Output Capacitance		$C_{ob}$	$V_{CB}=-10V, I_E=0, f=1MHz$	-	42	-	pF
Switching Time	Turn On Time	$t_{on}$	$I_C=-0.5A, R_L=500\Omega,$ $I_{B1}=-I_{B2}=-0.1A, V_{CC}=-250V$	-	0.1	0.5	$\mu s$
	Storage Time	$t_{stg}$		-	3.5	5.0	
	Fall Time	$t_f$		-	0.08	0.5	

Note :  $h_{FE}$  Classification O:30~80, Y:60~120.

# KTA1807D/L

REVERSE BIAS  
SAFE OPERATING AREA

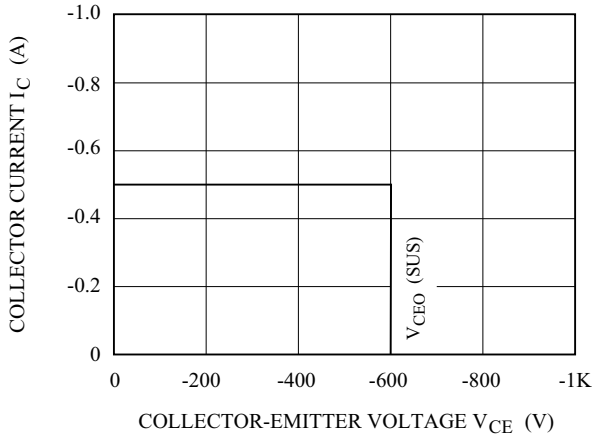

$I_C - V_{CE}$

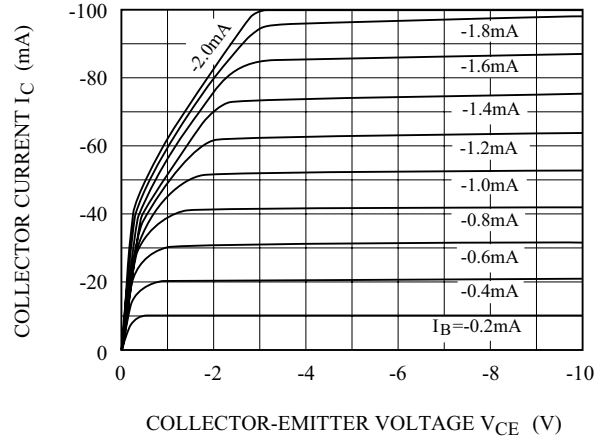

$I_C - V_{BE}$

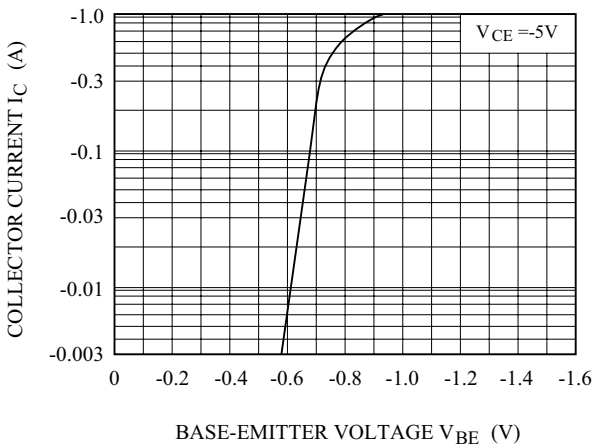

$h_{FE} - I_C$

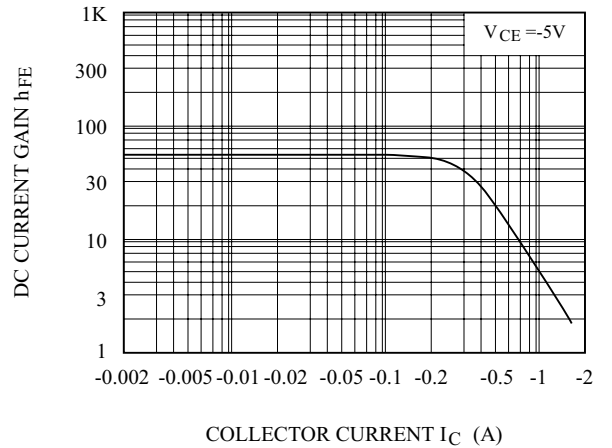

$V_{CE(sat)}, V_{BE(sat)} - I_C$

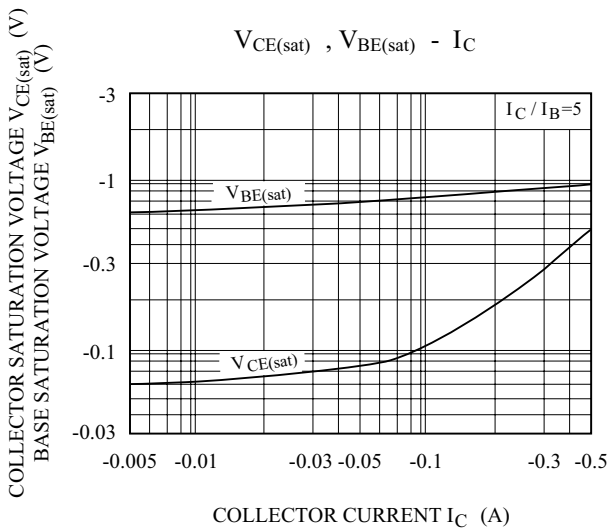

$t - I_C$

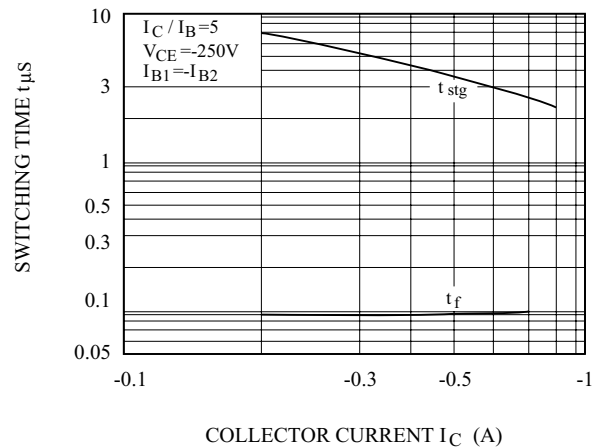

# KTA1807D/L

