

DATA SHEET

SKY13364-389LF: 0.4-2.2 GHz GaAs SP10T Switch

Applications

- 2G/3G multimode cellular handsets (UMTS, CDMA2000, EDGE, GSM)
- Embedded data cards

Features

- Broadband frequency range: 0.4 to 2.2 GHz
- Four CMOS/TTL control voltages (0/1.35 to 3.1 V)
- Single, positive DC power supply (2.5 to 3.3 V)
- Integrated, low-pass harmonic filter for GSM transmit paths
- Integrated CMOS decoder
- Small QFN (26-pin, 3.0 x 3.8 mm) package (MSL1, 260 °C per JEDEC J-STD-020)



Skyworks Green™ products are compliant with all applicable legislation and are halogen-free. For additional information, refer to *Skyworks Definition of Green™*, document number SQ04-0074.

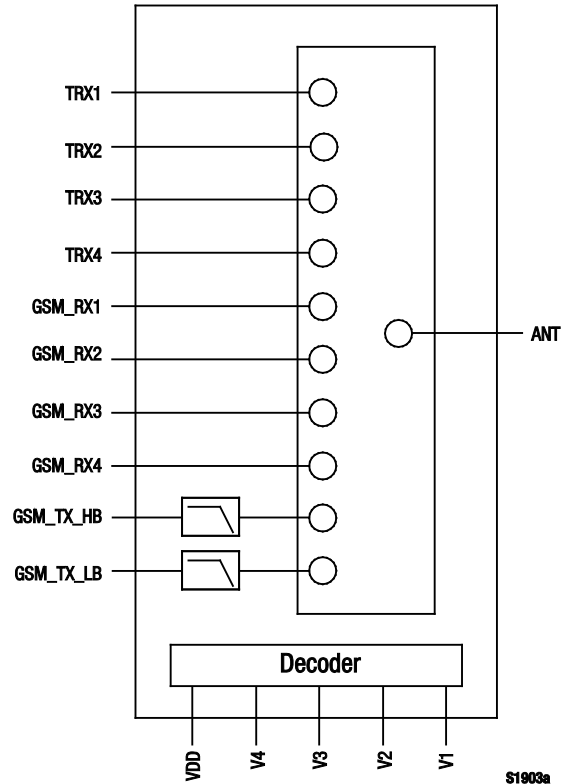

Figure 1. SKY13364-389LF Block Diagram

Description

The SKY13364-389LF is a GaAs pHEMT Single Pole, Ten-Throw (SP10T) antenna switch with an integrated CMOS decoder and dual low-pass harmonic filters. The switch has four WCDMA transmit/receive ports, four GSM receive ports, and two GSM transmit ports that make the device ideal for cellular handset and data card applications.

Using advance switching technologies, the SKY13364-389LF maintains low insertion loss and high isolation for both transmit and receive switching paths. The switch exhibits an excellent 2nd/3rd order modulation distortion performance.

Switching is controlled by four CMOS/TTL-compatible control voltage inputs (V1, V2, V3, and V4). Depending on the logic voltage level applied to the control pins, the antenna pin is connected to one of ten switched RF ports using a low insertion loss path, while the paths between the antenna pin and the other RF pins are in a high isolation state. No external DC blocking capacitors are required on the RF paths

The SKY13364-389LF is manufactured in a compact, 3.0 x 3.8 mm, 26-pin Quad Flat No-Lead (QFN) package.

A functional block diagram is shown in Figure 1. The pin configuration and package are shown in Figure 2. Signal pin assignments and functional pin descriptions are provided in Table 1.

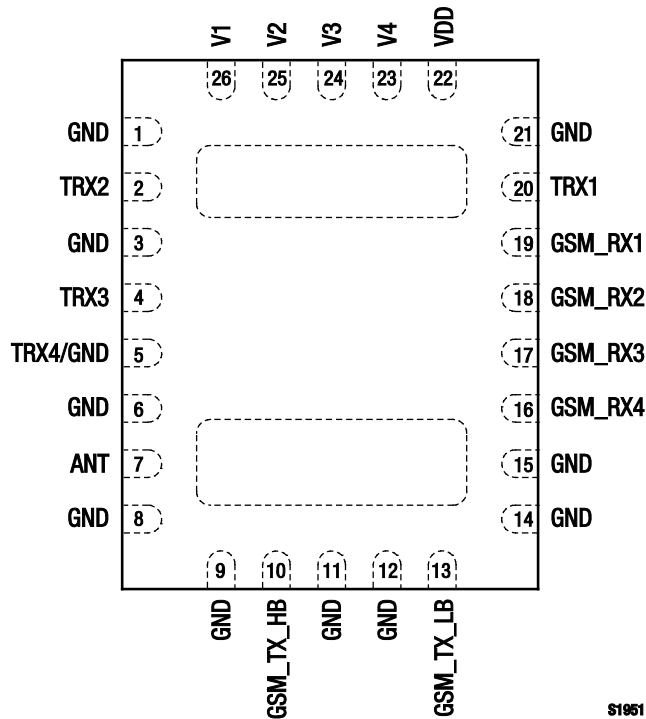

Figure 2. SKY13364-389LF Pinout – 26-Pin QFN (Top View)

Table 1. SKY13364-389LF Signal Descriptions

Pin #	Name	Description	Pin #	Name	Description
1	GND	Ground	14	GND	Ground
2	TRX2	RF input/output port 2	15	GND	Ground
3	GND	Ground	16	GSM_RX4	GSM RF output port 4
4	TRX3	RF input/output port 3	17	GSM_RX3	GSM RF output port 3
5	TRX4/GND	RF input/output port 4 for 10-throw switch; connect to ground for 9-throw switch.	18	GSM_RX2	GSM RF output port 2
6	GND	Ground	19	GSM_RX1	GSM RF output port 1
7	ANT	Antenna RF port	20	TRX1	RF input/output port 1
8	GND	Ground	21	GND	Ground
9	GND	Ground	22	VDD	DC power supply
10	GSM_TX_HB	GSM high band transmit RF input port with integrated harmonic filter	23	V4	DC input control voltage 4
11	GND	Ground	24	V3	DC input control voltage 3
12	GND	Ground	25	V2	DC input control voltage 2
13	GSM_TX_LB	GSM low band transmit RF input port with integrated harmonic filter	26	V1	DC input control voltage 1

Note: Bottom ground paddles must be connected to ground.

Table 2. SKY13364-389LF Absolute Maximum Ratings

Parameter	Symbol	Minimum	Typical	Maximum	Units
RF input power	P _{IN}			+36	dBm
Power supply				5	V
Control voltage	V _{CTL}			3.3	V
Storage temperature	T _{STG}	-40		+125	°C
Operating temperature	T _{OP}	-30		+90	°C

Note: Exposure to maximum rating conditions for extended periods may reduce device reliability. There is no damage to device with only one parameter set at the limit and all other parameters set at or below their nominal value. Exceeding any of the limits listed here may result in permanent damage to the device.

CAUTION: Although this device is designed to be as robust as possible, Electrostatic Discharge (ESD) can damage this device. This device must be protected at all times from ESD. Static charges may easily produce potentials of several kilovolts on the human body or equipment, which can discharge without detection. Industry-standard ESD precautions should be used at all times.

Functional Description

The time from when V_{DD} is applied to when the switch is active is the startup time. Once the startup time has passed, the control voltages can be applied. RF power should not be applied during the startup time or damage to the device could result.

The recommended startup sequence is:

- Step 1: Apply V_{DD}.
- Step 2: Apply V1 to V4 voltages.
- Step 3: Apply the RF input.

Recommended startup time is 25 μs.

The device must be turned off in the reverse order.

Typical performance characteristics are illustrated in Figures 3 to 14.

The state of the SKY13364-389LF is determined by the logic provided in Table 4.

Figure 15 illustrates the test setup used to measure data for Figure 12. This industry standardized test is used to simulate the WCDMA Band 1 linearity of the antenna switch. A +20 dBm Continuous Wave (CW) signal, P_{FUND}, is sequentially applied to the TRX1 through TRX4 ports, while a -15 dBm CW blocker signal, P_{BLK}, is applied to the ANT port.

The resulting 3rd Order Intermodulation Distortion (IMD3), f_{rx}, is measured over all phases of P_{FUND}. The SKY13364-389LF exhibits exceptional performance for all TRX ports.

Electrical and Mechanical Specifications

The absolute maximum ratings of the SKY13364-389LF are provided in Table 2. Electrical specifications are provided in Table 3.

Table 3. SKY13364-389LF Electrical Specifications (Note 1) (1 of 2)

(V_{DD} = 2.65 V, V₁ = V₂ = V₃ = V₄ = 0/1.8 V, T_{OP} = +25 °C, P_{IN} = 0 dBm, Characteristic Impedance [Z₀] = 50 Ω, Unless Otherwise Noted)

Parameter	Symbol	Test Condition	Min	Typical	Max	Units	
RF Specifications							
Insertion loss (TRX1)	IL	ANT to TRX1					
		824 to 960 MHz 1710 to 2170 MHz		0.50 0.70	0.60 0.80	dB dB	
Insertion loss (TRX2, TRX3, TRX4)	IL	ANT to TRX2, TRX3, TRX4					
		824 to 960 MHz 1710 to 2170 MHz		0.60 0.75	0.70 0.85	dB dB	
Insertion loss (GSM transmit low band)		ANT to GSM_TX_LB, 824 to 915 MHz		1.0	1.2	dB	
Insertion loss (GSM transmit high band)		ANT to GSM_TX_HB, 1710 to 1910 MHz		1.1	1.3	dB	
Insertion loss (GSM_RX1, GSM_RX2, GSM_RX3, GSM_RX4)		ANT to RX ports					
		869 to 960 MHz 1805 to 1990 MHz		0.8 1.0	1.0 1.2	dB dB	
Isolation	ISO	0.4 to 2.2 GHz, TRX1 to TRX2, TRX3, and TRX4 ports	30			dB	
		824 to 915 MHz, GSM_TX_LB to TRX/GSM receive ports	35			dB	
		1710 to 1910 MHz, GSM_TX_HB to TRX/GSM receive ports	32			dB	
		824 to 1910 MHz, TRX2/TRX3 to TRX3/TRX4 ports	20			dB	
Harmonics		UMTS, P _{IN} = +27 dBm			-36	dBm	
		GSM_TX_LB port, P _{IN} = +35 dBm		-45	-36	dBm	
		GSM_TX_HB port, P _{IN} = +32 dBm		-45	-36	dBm	
GSM transmit attenuation (low band) GSM850	Attn	2f	22	25		dB	
		3f	25	28		dB	
		4f	17	20		dB	
		EGSM900	2f	25	28		dB
			3f	25	28		dB
			4f	17	20		dB
GSM transmit attenuation (high band): DCS1800	Attn	2f	22	25		dB	
		3f	25	28		dB	
		PCS1900	2f	25	28		dB
			3f	25	28		dB
			Return loss	IS111	0.4 to 2.2 GHz	14	18
		2 nd Order Input Intercept Point	IIP2	AWS, PCS, IMT to CDMA2000 modes	+95.5		dBm
3 rd Order Intermodulation Distortion	IMD3	UMTS mode		-105	-97	dBm	

Table 3. SKY13364-389LF Electrical Specifications (Note 1) (2 of 2)

($V_{DD} = 2.65\text{ V}$, $V_1 = V_2 = V_3 = V_4 = 0/1.8\text{ V}$, $T_{OP} = +25\text{ }^\circ\text{C}$, $P_{IN} = 0\text{ dBm}$, Characteristic Impedance [Z_0] = $50\ \Omega$, Unless Otherwise Noted)

Parameter	Symbol	Test Condition	Min	Typical	Max	Units
RF Specifications (continued)						
GSM transmit low band 1 dB Input Compression Point	IP1dB	824 to 915 MHz	+40			dBm
GSM transmit high band 1 dB Input Compression Point	IP1dB	1710 to 1910 MHz	+39			dBm
Switching speed		10/90% RF		3	5	μs
DC Specifications						
Supply voltage	V_{DD}		2.50	2.65	3.30	V
Supply current	I_{DD}			0.3	0.6	mA
Control voltage: High Low	V_1, V_2, V_3, V_4		1.35 0	1.80	3.10 0.3	V V
Control current: High Low				1 1	10 10	μA μA

Note 1: Performance is guaranteed only under the conditions listed in this Table.

Typical Performance Characteristics

($V_{DD} = 2.65\text{ V}$, $V_1 = V_2 = V_3 = V_4 = 0/1.8\text{ V}$, $T_{OP} = +25\text{ }^\circ\text{C}$, $P_{IN} = 0\text{ dBm}$, Characteristic Impedance [Z_0] = $50\ \Omega$, Unless Otherwise Noted)

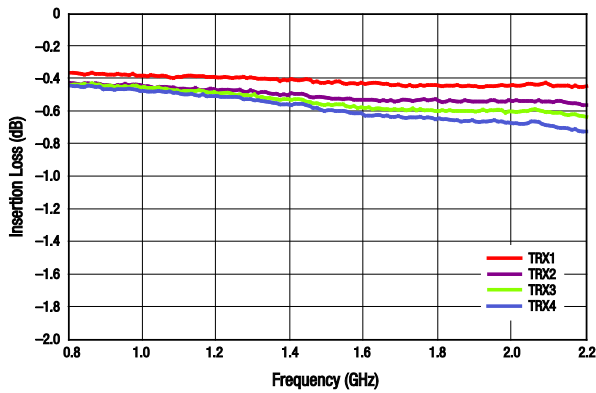

Figure 3. Insertion Loss vs Frequency (ANT to TRX Ports)

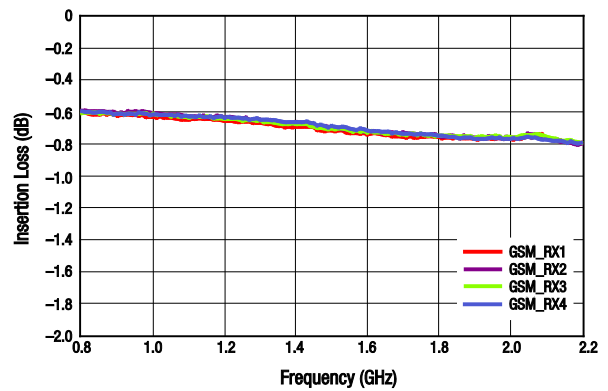

Figure 4. Insertion Loss vs Frequency (ANT to GSM_RX Ports)

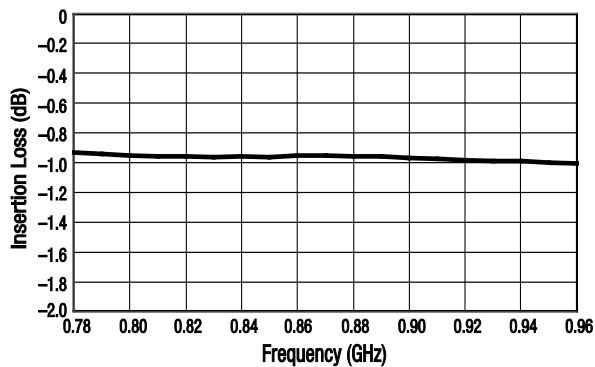

Figure 5. Insertion Loss vs Frequency (ANT to GSM_TX_LB Port)

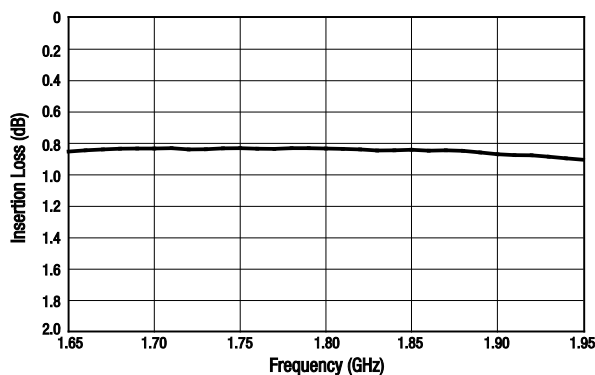

Figure 6. Insertion Loss vs Frequency (ANT to GSM_TX_HB Port)

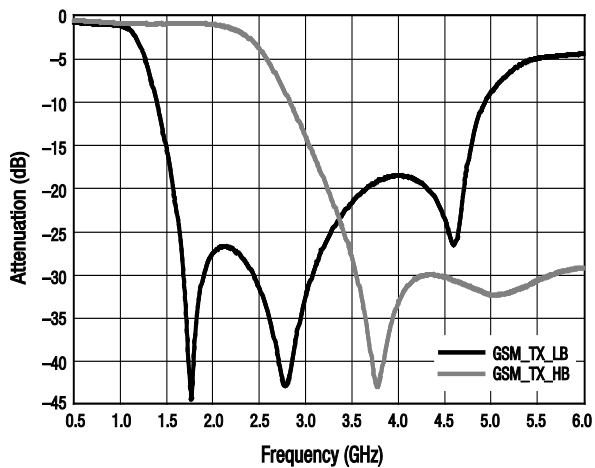

Figure 7. Attenuation vs Frequency (ANT to GSM_TX_HB/LB Ports)

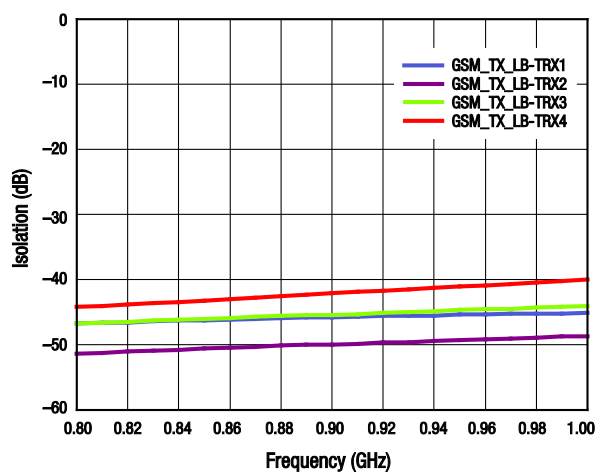

Figure 8. Isolation vs Frequency (GSM_TX_LB to TRX Ports)

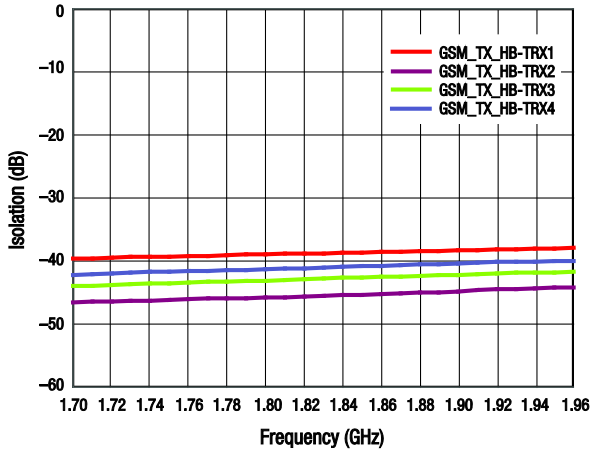

Figure 9. Isolation vs Frequency (GSM_TX_HB to TRX Ports)

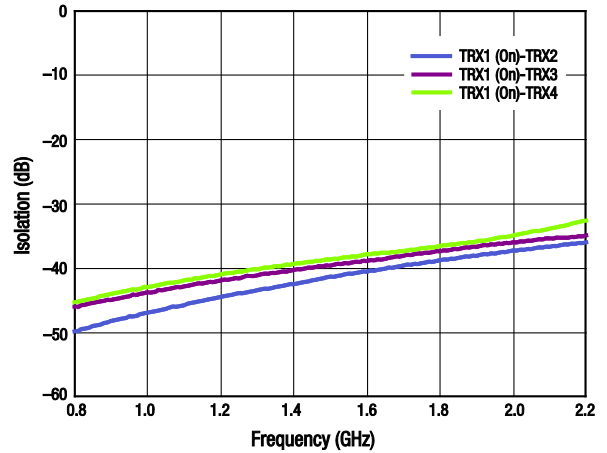

Figure 10. Isolation vs Frequency (TRX to TRX Ports)

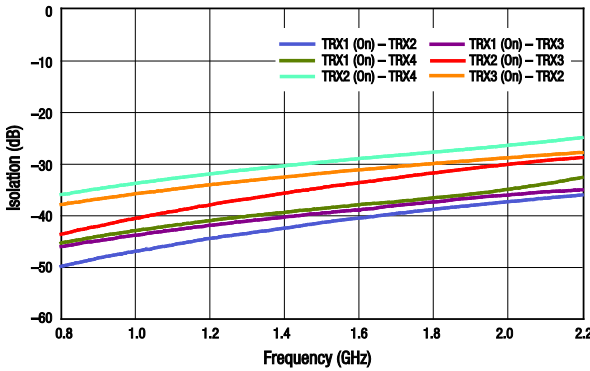

Figure 11. Isolation vs Frequency (TRX to TRX Ports)

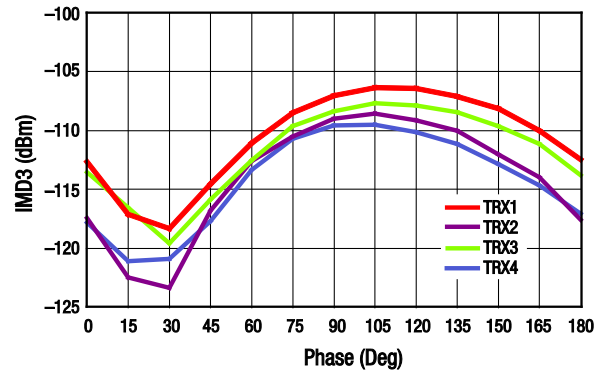

Figure 12. 3rd Order Intermodulation Distortion vs Phase, TRX Ports ($P_{FUND} = 1.95$ GHz, $f_{BLK} = 1.76$ GHz, $f_{RX} = 2.14$ GHz)

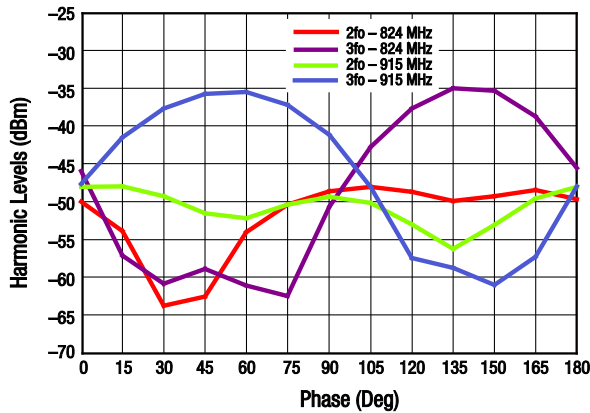

Figure 13. Harmonics vs Phase (ANT to GSM_TX_LB, $P_{IN} = +35$ dBm, 5:1 VSWR Mismatch)

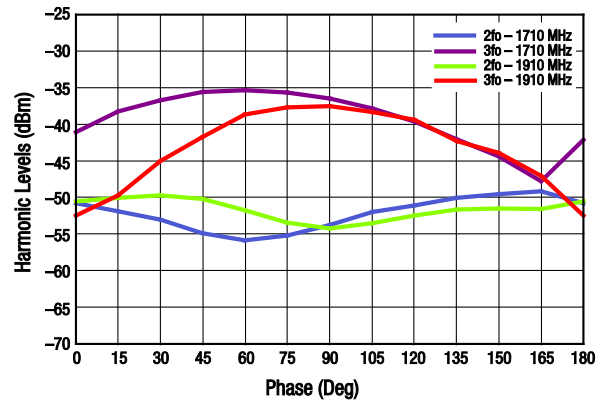

Figure 14. Harmonics vs Phase ($P_{IN} = +33$ dBm, 5:1 VSWR Mismatch)

Table 4. SKY13364-389LF Truth Table

Insertion Loss State	V1 (Pin 26)	V2 (Pin 25)	V3 (Pin 24)	V4 (Pin 23)
ANT to GSM_TX_LB	1	1	0	0
ANT to GSM_TX_HB	1	0	0	0
ANT to GSM_RX1	0	0	0	0
ANT to GSM_RX2	0	0	1	0
ANT to GSM_RX3	0	1	1	0
ANT to GSM_RX4	0	1	0	0
ANT to TRX1	1	0	1	0
ANT to TRX2	1	1	1	0
ANT to TRX3	1	0	1	1
ANT to TRX4	1	1	1	1

Note: "1" = +1.35 V to +3.10 V (1.8 V typical). "0" = 0 V to +0.3 V. Any state other than described in this Table places the switch into an undefined state. An undefined state will not damage the device.

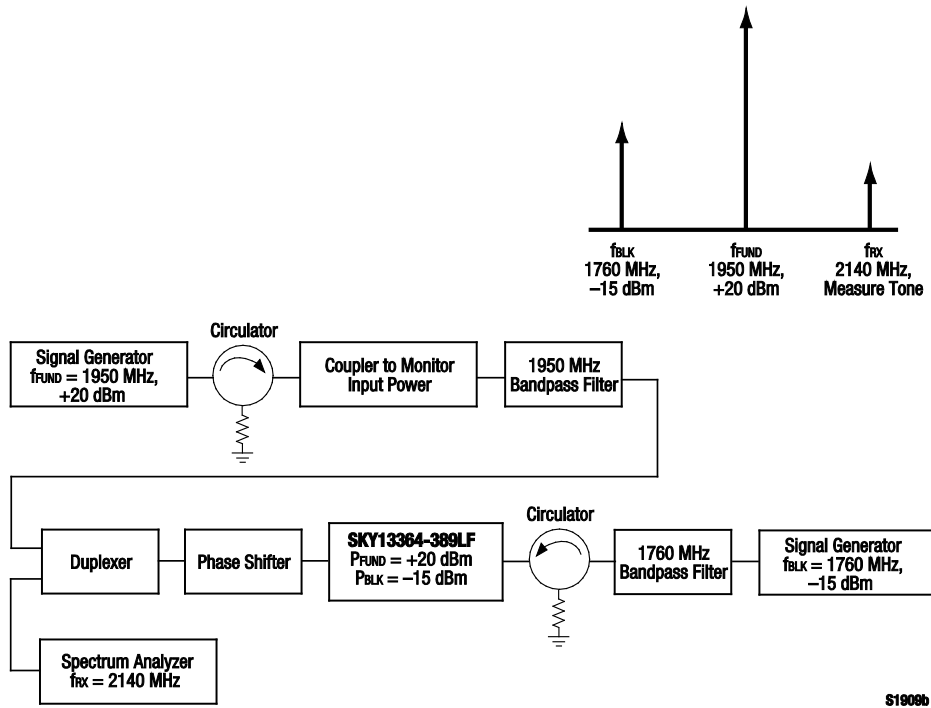

Figure 15. 3rd Order Intermodulation Test Setup

Evaluation Board Description

The SKY13364-389LF Evaluation Board is used to test the performance of the SKY13364-389LF SP10T Switch. An Evaluation Board schematic diagram is provided in Figure 16. An assembly drawing for the Evaluation Board is shown in Figure 17.

Package Dimensions

The PCB layout footprint for the SKY13364-389LF is provided in Figure 18. Typical case markings are shown in Figure 19. Package dimensions for the 26-pin QFN are shown in Figure 20, and tape and reel dimensions are provided in Figure 21.

Package and Handling Information

Instructions on the shipping container label regarding exposure to moisture after the container seal is broken must be followed. Otherwise, problems related to moisture absorption may occur when the part is subjected to high temperature during solder assembly.

The SKY13364-389LF is rated to Moisture Sensitivity Level 1 (MSL1) at 260 °C. It can be used for lead or lead-free soldering.

Care must be taken when attaching this product, whether it is done manually or in a production solder reflow environment. Production quantities of this product are shipped in a standard tape and reel format.

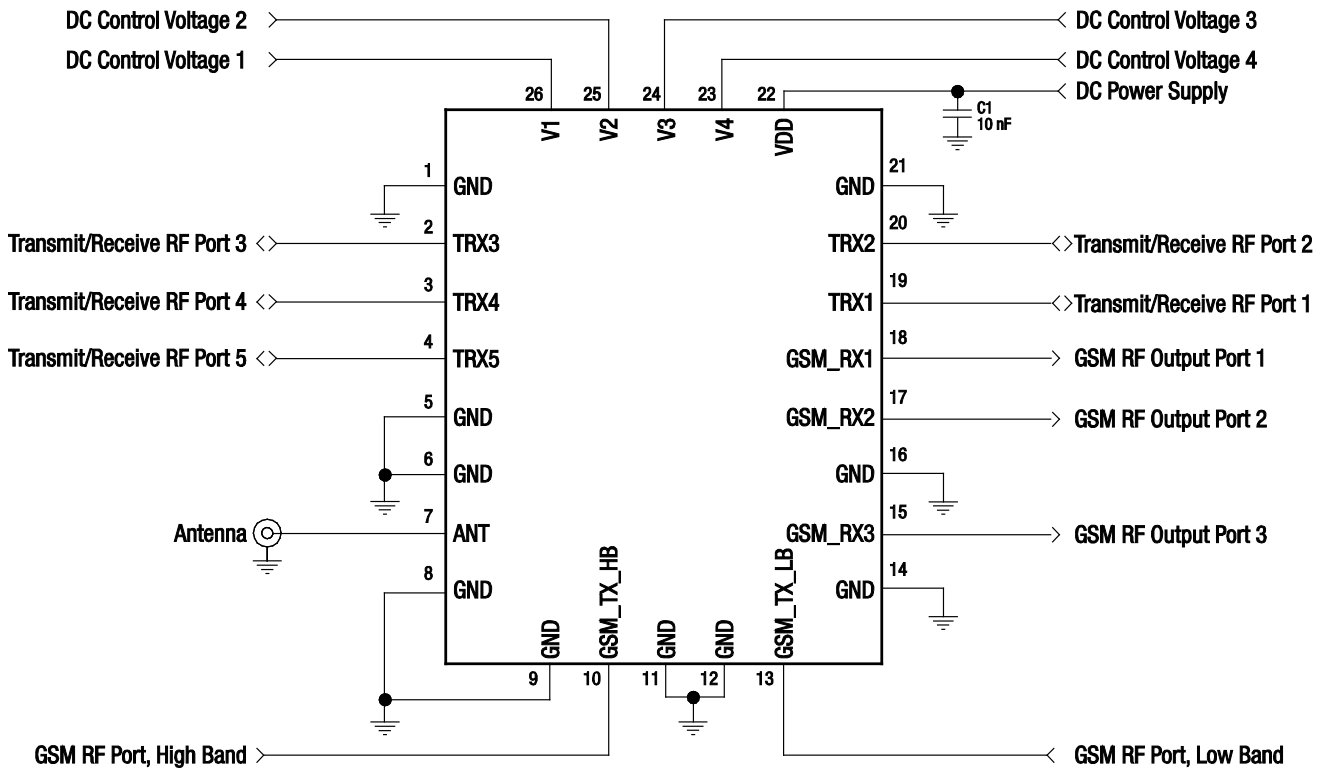

S1906

Figure 16. SKY13364-389LF Evaluation Board Schematic

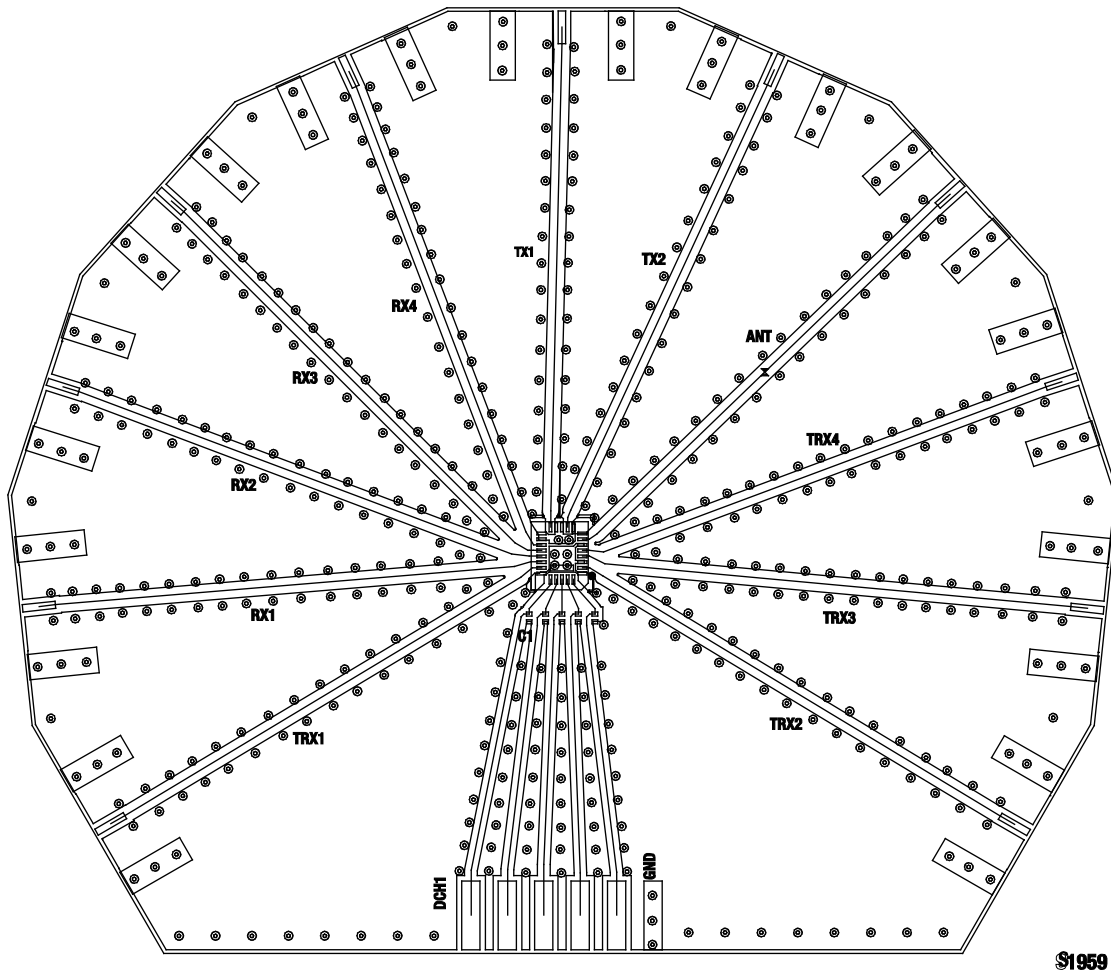

Figure 17. SKY13364-389LF Evaluation Board Assembly Diagram

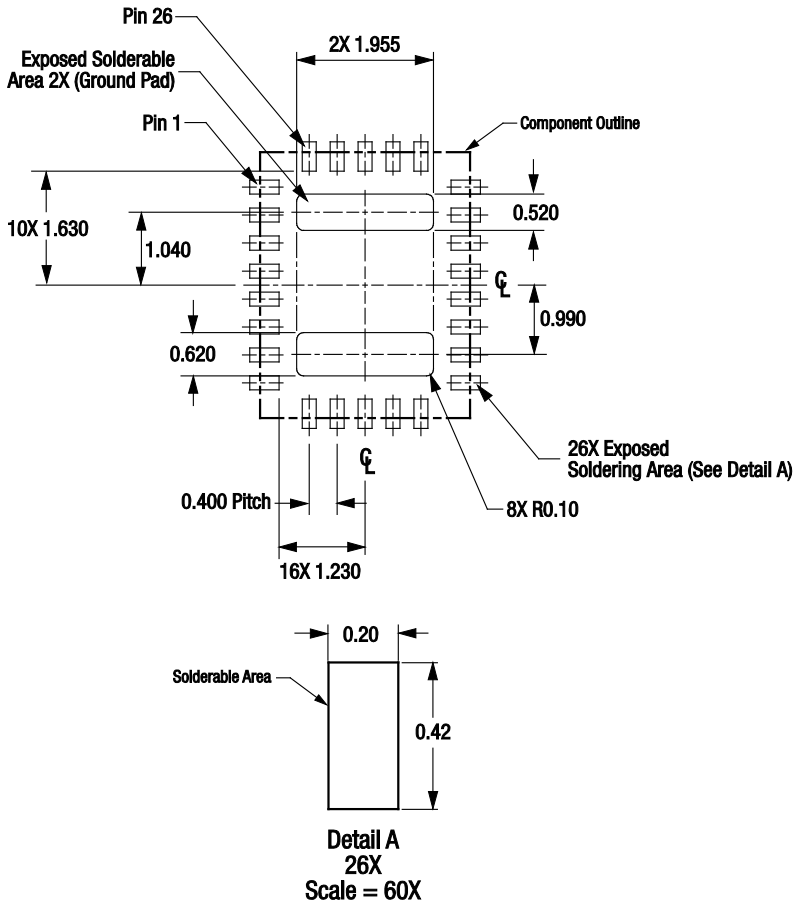

Figure 18. SKY13364-389LF PCB Layout Footprint (Top View)

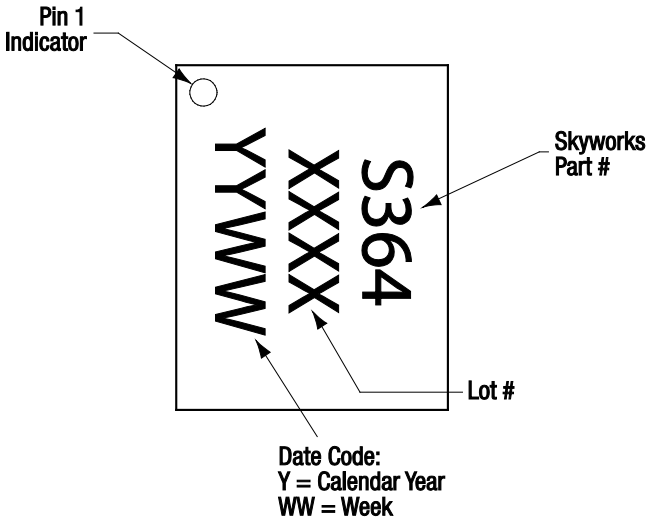
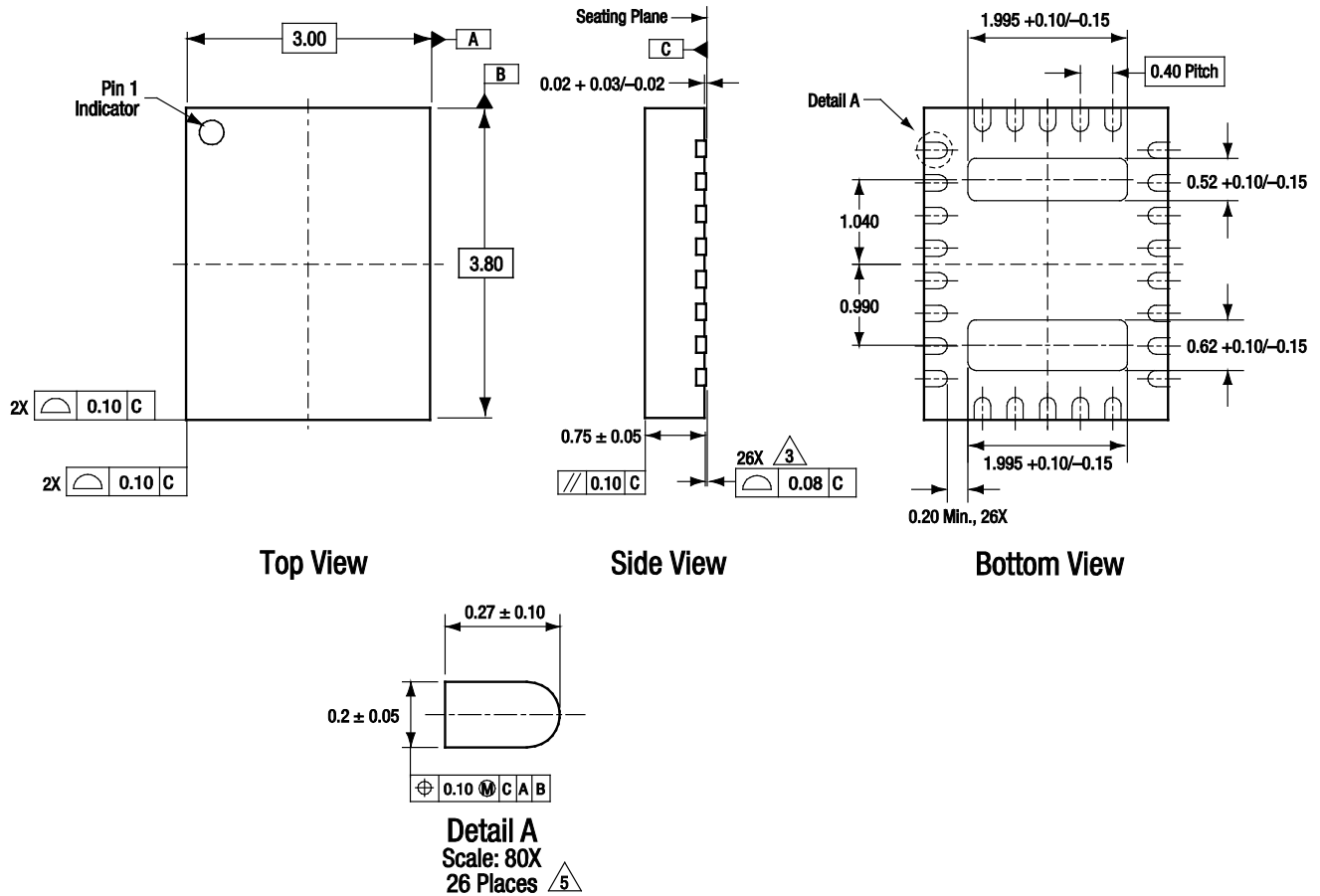

Figure 19. Typical Part Markings (Top View)



All measurements are in millimeters.
Dimensioning and tolerancing according to ASME Y14.5M-1994.
Coplanarity applies to the exposed bottom surface metalization, as well as the terminals.
Plating requirement per source control drawing (SCD) 2504.

S1904

Figure 20. SKY13364-389LF 26-Pin QFN Package Dimensions

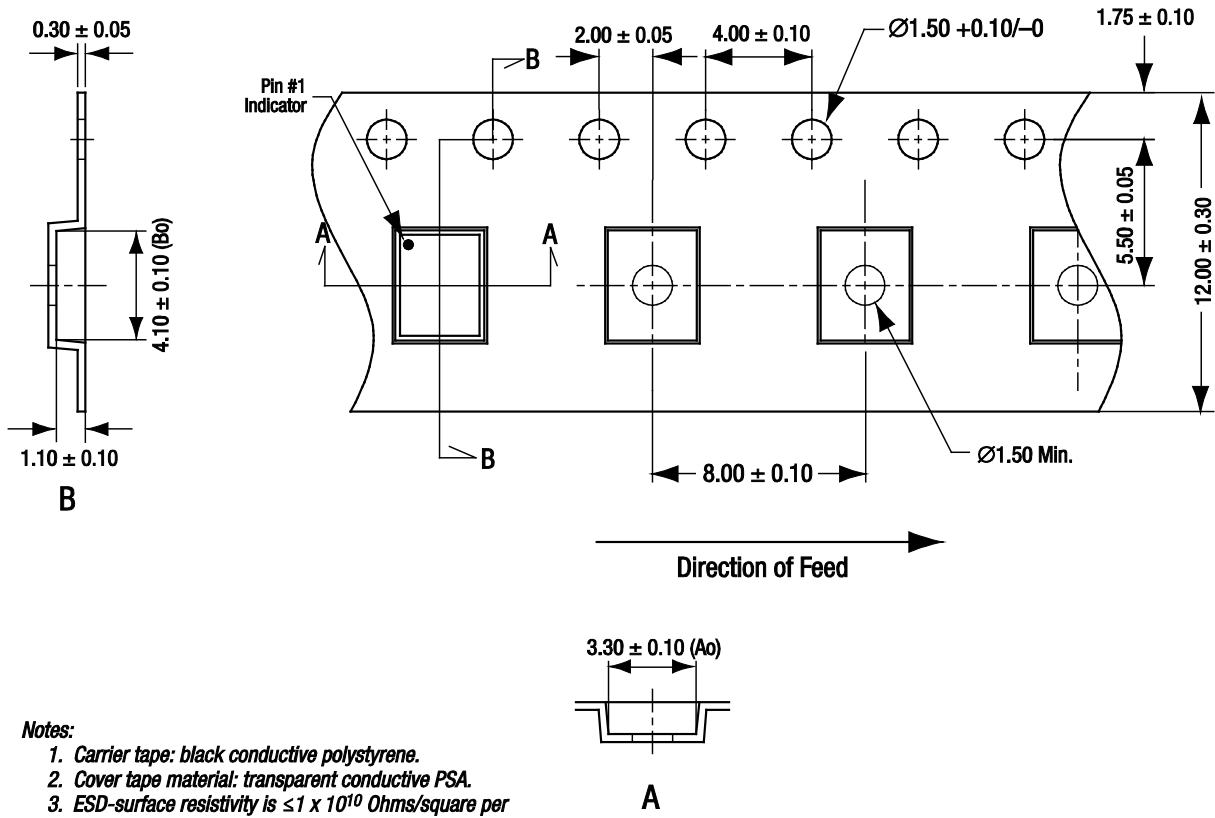

- Notes:**
1. Carrier tape: black conductive polystyrene.
 2. Cover tape material: transparent conductive PSA.
 3. ESD-surface resistivity is $\leq 1 \times 10^{10}$ Ohms/square per EIA, JEDEC TNR Specification.
 4. Ten sprocket hole pitch cumulative tolerance: ± 0.20 mm.
 5. Ao and Bo measured on plane 0.30 mm above the bottom of the pocket.
 6. All measurements are in millimeters.

S2141

Figure 21. SKY13364-389LF Tape and Reel Dimensions

Ordering Information

Model Name	Manufacturing Part Number	Evaluation Board Part Number
SKY13364-389LF 0.4-2.2 GHz SP10T Switch	SKY13364-389LF	SKY13364-389LF-EVB

Copyright © 2010, 2012 Skyworks Solutions, Inc. All Rights Reserved.

Information in this document is provided in connection with Skyworks Solutions, Inc. (“Skyworks”) products or services. These materials, including the information contained herein, are provided by Skyworks as a service to its customers and may be used for informational purposes only by the customer. Skyworks assumes no responsibility for errors or omissions in these materials or the information contained herein. Skyworks may change its documentation, products, services, specifications or product descriptions at any time, without notice. Skyworks makes no commitment to update the materials or information and shall have no responsibility whatsoever for conflicts, incompatibilities, or other difficulties arising from any future changes.

No license, whether express, implied, by estoppel or otherwise, is granted to any intellectual property rights by this document. Skyworks assumes no liability for any materials, products or information provided hereunder, including the sale, distribution, reproduction or use of Skyworks products, information or materials, except as may be provided in Skyworks Terms and Conditions of Sale.

THE MATERIALS, PRODUCTS AND INFORMATION ARE PROVIDED “AS IS” WITHOUT WARRANTY OF ANY KIND, WHETHER EXPRESS, IMPLIED, STATUTORY, OR OTHERWISE, INCLUDING FITNESS FOR A PARTICULAR PURPOSE OR USE, MERCHANTABILITY, PERFORMANCE, QUALITY OR NON-INFRINGEMENT OF ANY INTELLECTUAL PROPERTY RIGHT; ALL SUCH WARRANTIES ARE HEREBY EXPRESSLY DISCLAIMED. SKYWORKS DOES NOT WARRANT THE ACCURACY OR COMPLETENESS OF THE INFORMATION, TEXT, GRAPHICS OR OTHER ITEMS CONTAINED WITHIN THESE MATERIALS. SKYWORKS SHALL NOT BE LIABLE FOR ANY DAMAGES, INCLUDING BUT NOT LIMITED TO ANY SPECIAL, INDIRECT, INCIDENTAL, STATUTORY, OR CONSEQUENTIAL DAMAGES, INCLUDING WITHOUT LIMITATION, LOST REVENUES OR LOST PROFITS THAT MAY RESULT FROM THE USE OF THE MATERIALS OR INFORMATION, WHETHER OR NOT THE RECIPIENT OF MATERIALS HAS BEEN ADVISED OF THE POSSIBILITY OF SUCH DAMAGE.

Skyworks products are not intended for use in medical, lifesaving or life-sustaining applications, or other equipment in which the failure of the Skyworks products could lead to personal injury, death, physical or environmental damage. Skyworks customers using or selling Skyworks products for use in such applications do so at their own risk and agree to fully indemnify Skyworks for any damages resulting from such improper use or sale.

Customers are responsible for their products and applications using Skyworks products, which may deviate from published specifications as a result of design defects, errors, or operation of products outside of published parameters or design specifications. Customers should include design and operating safeguards to minimize these and other risks. Skyworks assumes no liability for applications assistance, customer product design, or damage to any equipment resulting from the use of Skyworks products outside of stated published specifications or parameters.

Skyworks, the Skyworks symbol, and “Breakthrough Simplicity” are trademarks or registered trademarks of Skyworks Solutions, Inc., in the United States and other countries. Third-party brands and names are for identification purposes only, and are the property of their respective owners. Additional information, including relevant terms and conditions, posted at www.skyworksinc.com, are incorporated by reference.