



HMC1042LC4

GaAs MMIC I/Q MIXER 15 - 33.5 GHz

Typical Applications

The HMC1042LC4 is Ideal for:

- Point-to-Point Radio
- Point-to-Multi-Point Radio
- Test Equipment & Sensors
- Military End Use

Features

- Wide IF Bandwidth: DC - 3.5 GHz
- Image Rejection: 30 dBc
- LO to RF Isolation: 40 dB
- High Input IP3: +22 dBm
- 24 Lead 4x4 mm SMT Package: 16mm²

Functional Diagram

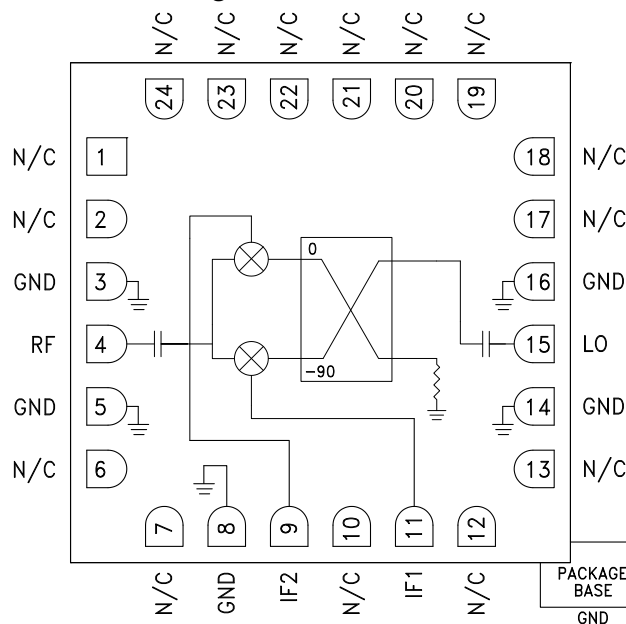

General Description

The HMC1042LC4 is a compact I/Q MMIC mixer in a leadless "Pb free" SMT package, which can be used as either an Image Reject Mixer or a Single Sideband Upconverter. The mixer utilizes two standard Hittite double balanced mixer cells and a 90 degree hybrid fabricated in a GaAs MESFET process. A low frequency quadrature hybrid was used to produce a 2000 MHz USB IF output. This product is a much smaller alternative to hybrid style Image Reject Mixers and Single Sideband Upconverter assemblies. The HMC1042LC4 eliminates the need for wire bonding and allows the use of surface mount manufacturing techniques.

Electrical Specifications, $T_A = +25\text{ }^\circ\text{C}$, $IF = 2\text{ GHz}$, USB , $LO = +15\text{ dBm}$ ^[1]

Parameter	Min.	Typ.	Max.	Min.	Typ.	Max.	Units
Frequency Range, RF/LO		15 - 25		25 - 33.5			GHz
Frequency Range, IF		DC - 3.5		DC - 3.5			GHz
Conversion Loss (As IRM)		9	12		11	14	dB
Image Rejection	16	24		16	30		dB
LO to RF Isolation	35	40		33	43		dBc
LO to IF Isolation		35			45		dB
IP3 (Input)		20			22		dBm
Amplitude Balance ^{[2] [3]}		±0.5			±0.5		dB
Phase Balance ^{[2] [3]}		±2.5			±2.5		Deg

[1] Unless otherwise noted, all measurements performed as downconverter.

[2] Data taken without external 90° hybrid.

[3] Data taken with IF = 100 MHz



**GaAs MMIC I/Q MIXER
15 - 33.5 GHz**

Data Taken As IRM with External IF 90° Hybrid, IF = 2000 MHz

Conversion Gain, USB vs. Temperature

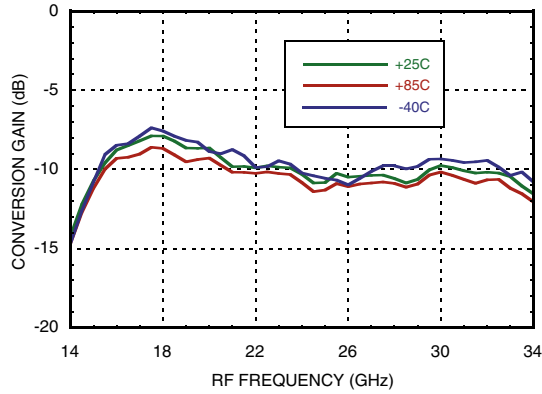

Conversion Gain, USB vs. LO Drive

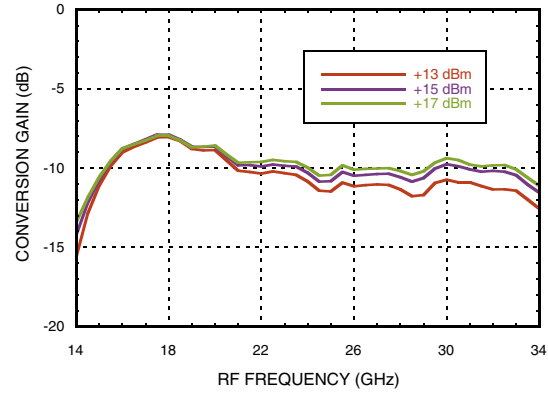

Image Rejection, USB vs. Temperature

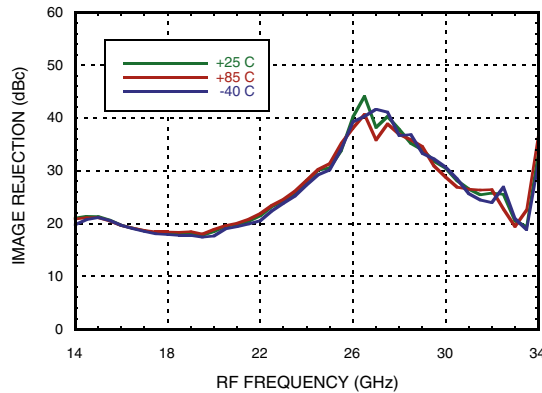
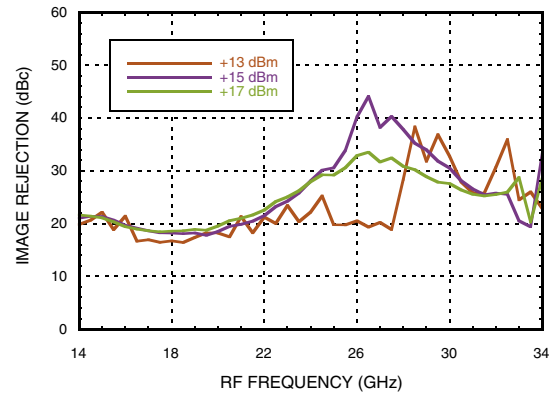
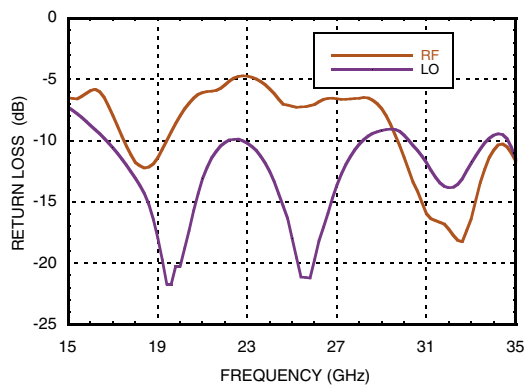

Image Rejection, USB vs. LO Drive



Return Loss [1]



Input P1dB, USB vs. Temperature

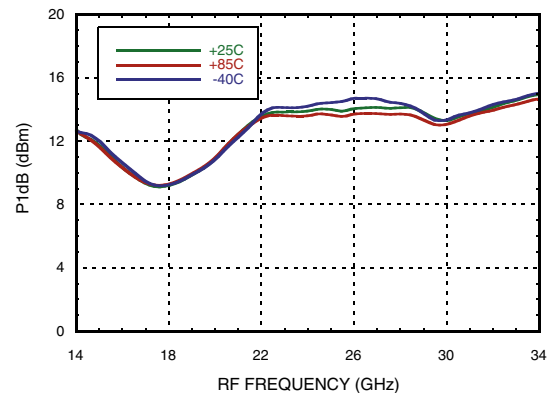

[1] Data taken without external 90° hybrid.



Data Taken As IRM with External IF 90° Hybrid, IF = 2000 MHz

Input IP3, USB vs. Temperature

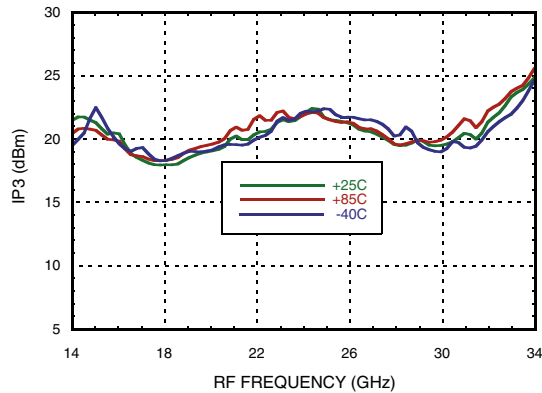

Input IP3, USB vs LO Drive

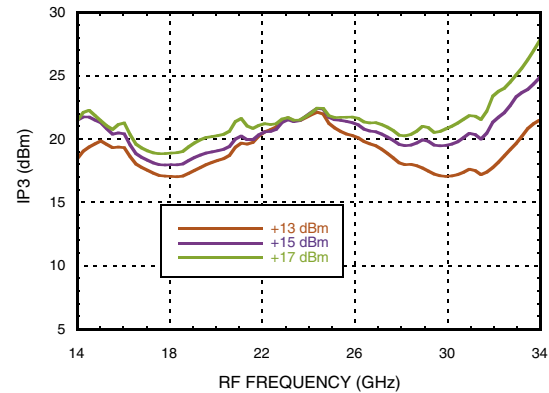

Isolation

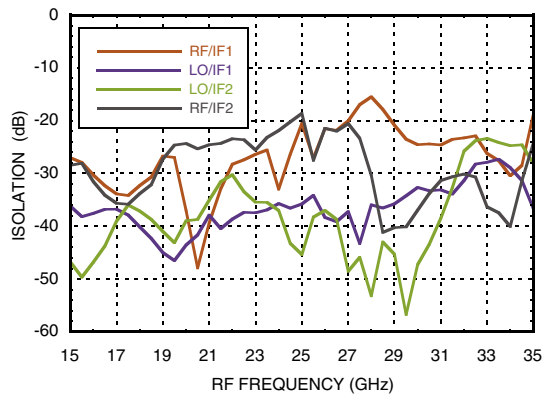

LO/RF Isolation

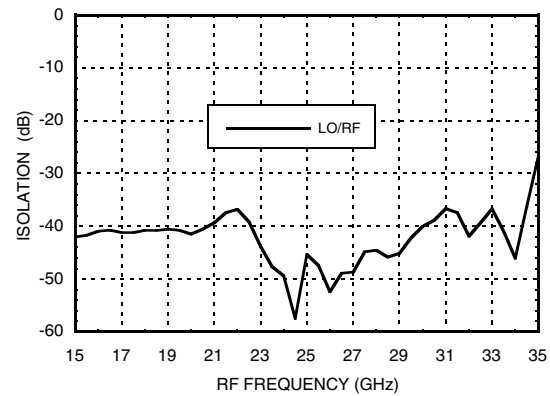

IF Bandwidth [1]

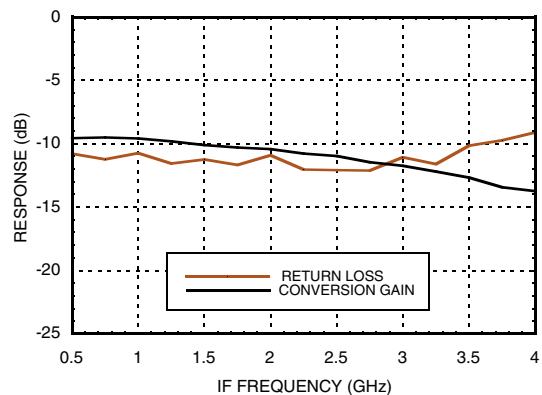

Amplitude Balance, USB vs. LO Drive [1] [2]

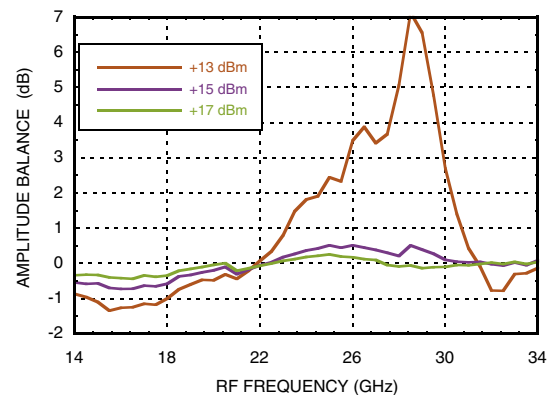

[1] Data taken without external 90° hybrid.

[2] Data taken with IF = 100 MHz.



**GaAs MMIC I/Q MIXER
15 - 33.5 GHz**

Data Taken As IRM with External IF 90° Hybrid, IF = 2000 MHz

Phase Balance, USB vs. LO Drive [1] [2]

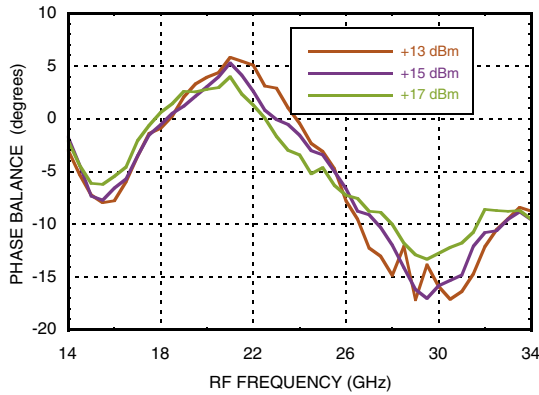

Upconverter Performance Conversion Gain, USB vs. LO Drive

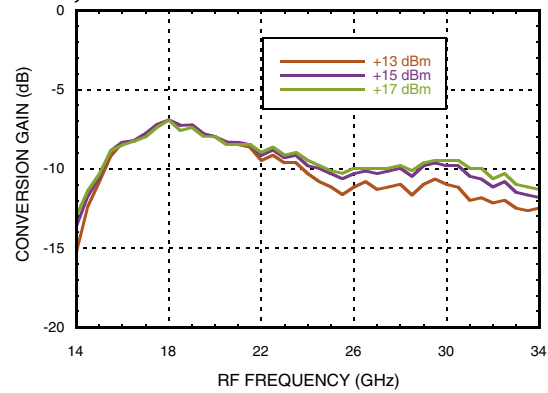

Upconverter Performance Sideband Rejection, USB vs. LO Drive

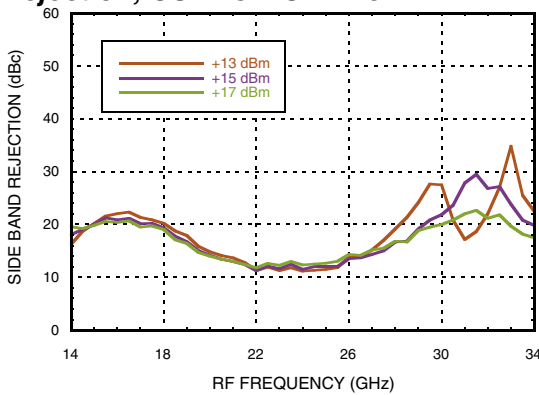

Conversion Gain, LSB vs. Temperature

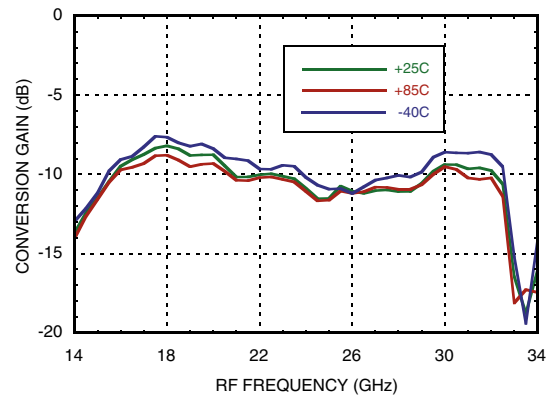

Conversion Gain, LSB vs. LO Drive

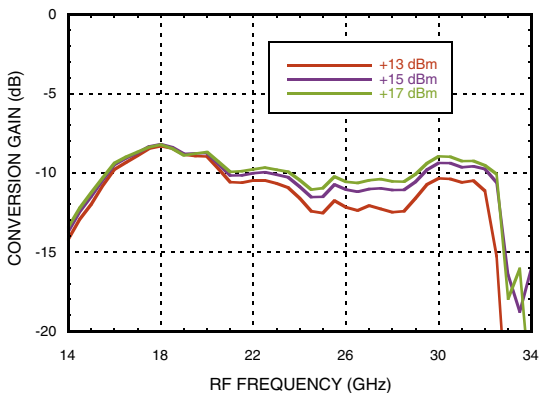
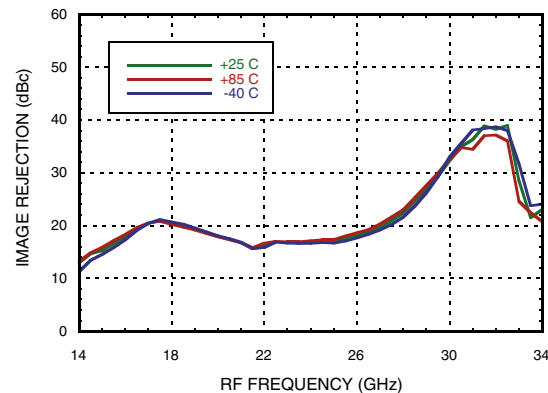

Image Rejection, LSB vs. Temperature



[1] Data taken without external 90° hybrid.

[2] Data taken with IF = 100 MHz.



Data Taken As IRM with External IF 90° Hybrid, IF = 2000 MHz

Image Rejection, LSB vs. LO Drive

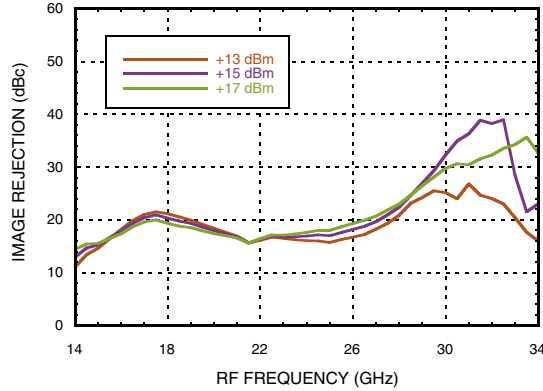

Input P1dB, LSB vs. Temperature

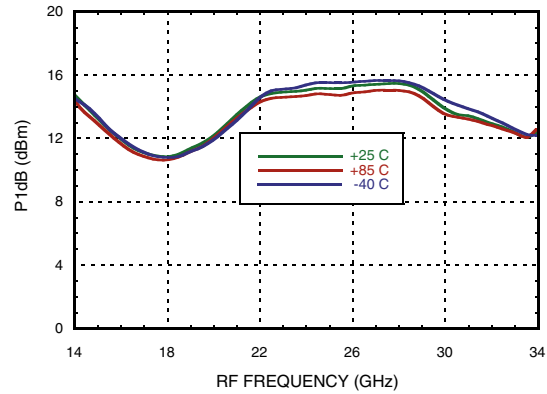

Input IP3, LSB vs. Temperature

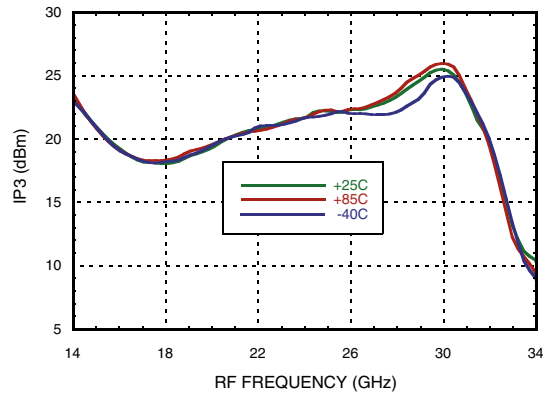

Input IP3, LSB vs LO Drive

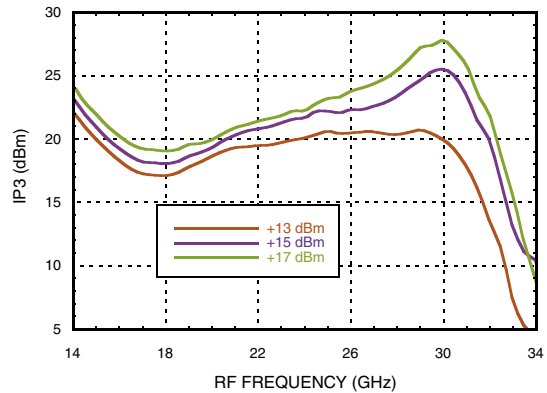

Amplitude Balance, LSB vs. LO Drive [1] [2]

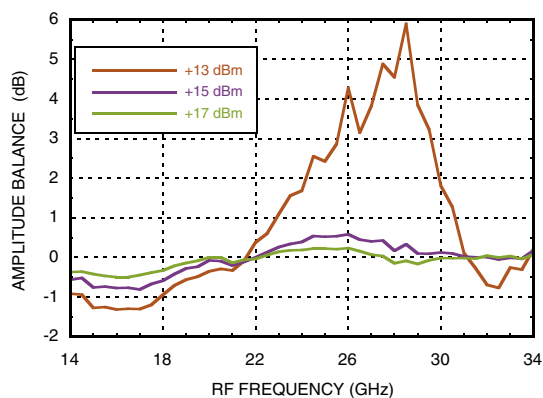

Phase Balance, LSB vs. LO Drive [1] [2]

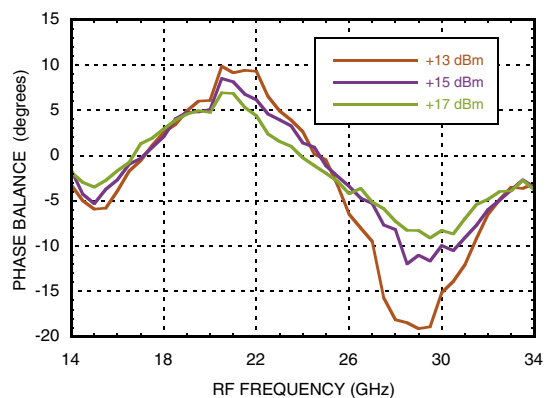

[1] Data taken without external 90° hybrid.

[2] Data taken with IF = 100 MHz.



Data Taken As IRM with External IF 90° Hybrid, IF = 1000 MHz

Conversion Gain, USB vs. Temperature

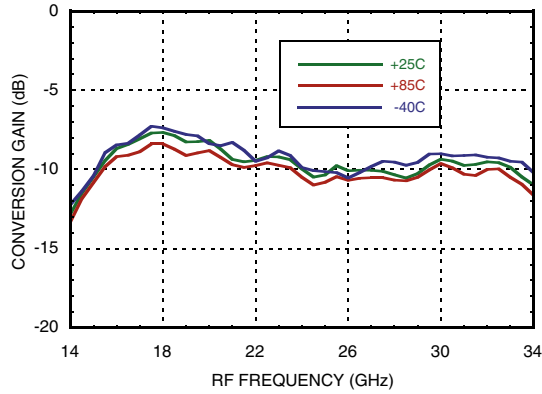

Conversion Gain, USB vs. LO Drive

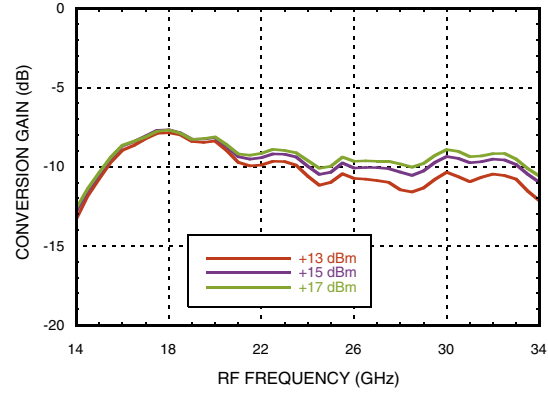

Image Rejection, USB vs. Temperature

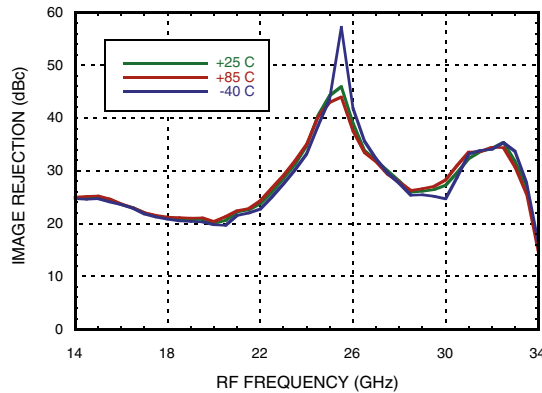
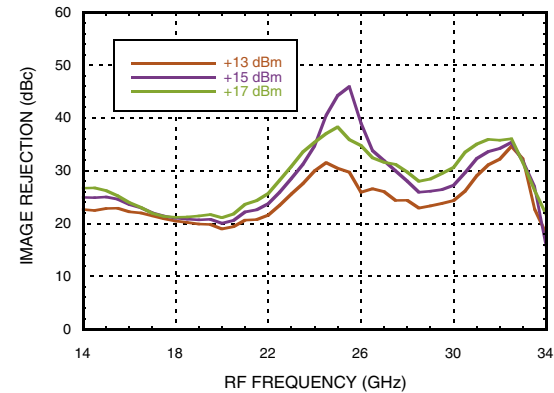
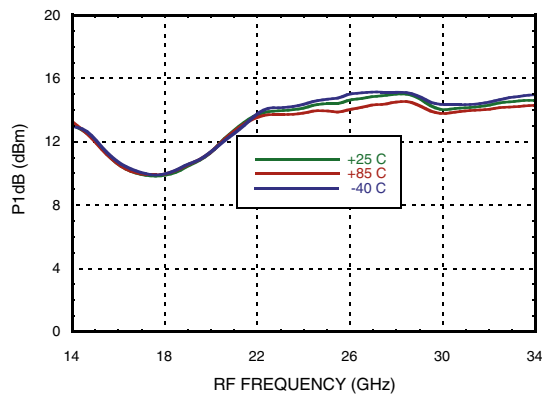

Image Rejection, USB vs. LO Drive



Input P1dB, USB vs. Temperature



Input IP3, USB vs. Temperature

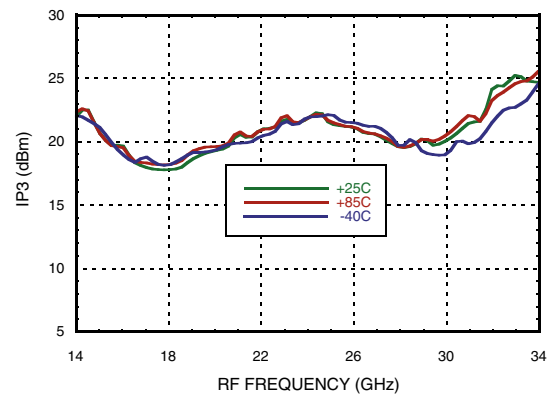



Data Taken As IRM with External IF 90° Hybrid, IF = 1000 MHz

Input IP3, USB vs LO Drive

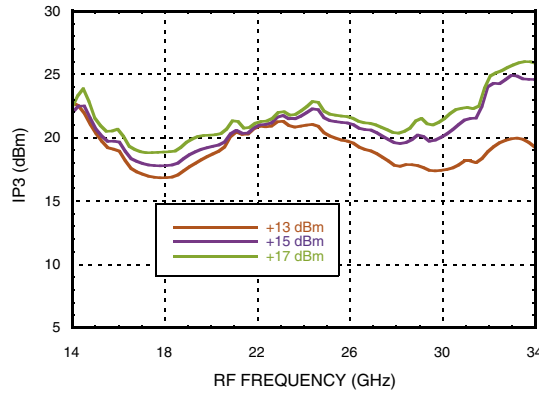

Conversion Gain, LSB vs. Temperature

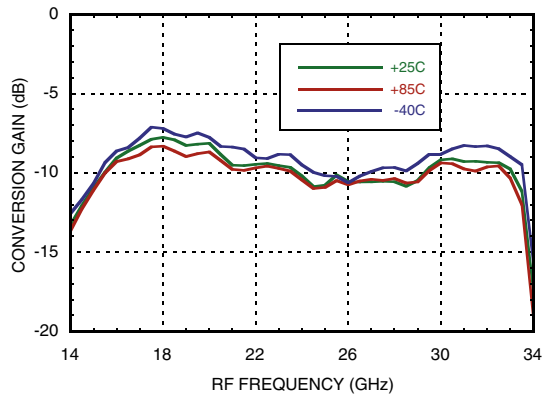

Conversion Gain, LSB vs. LO Drive

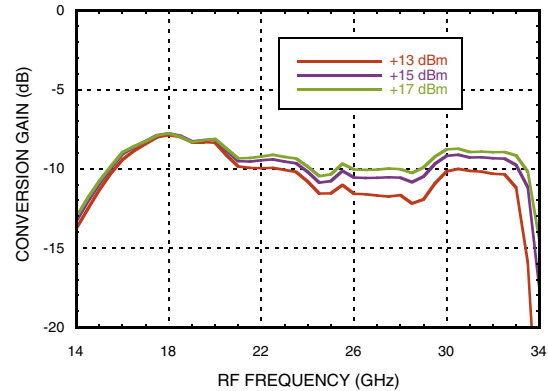

Image Rejection, LSB vs. Temperature

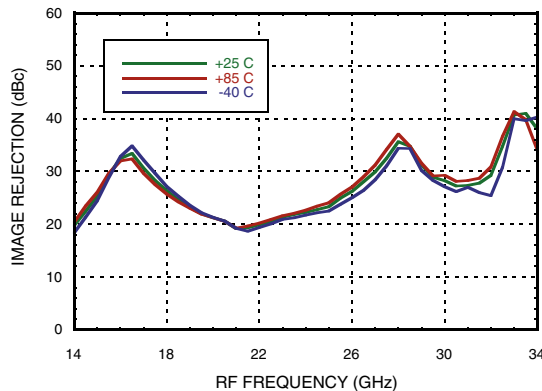
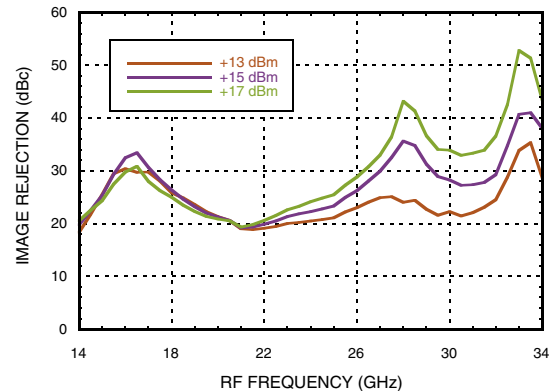

Image Rejection, LSB vs. LO Drive





Data Taken As IRM with External IF 90° Hybrid, IF = 1000 MHz

Input P1dB, LSB vs. Temperature

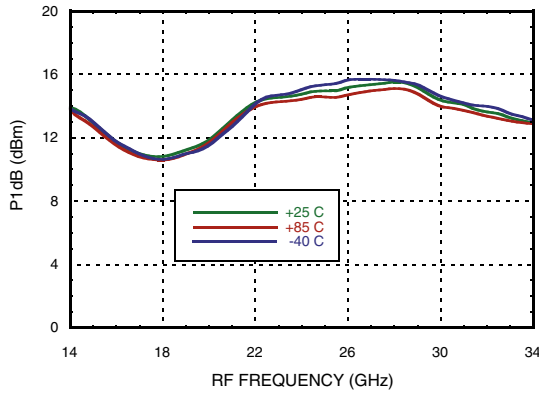

Input IP3, LSB vs. Temperature

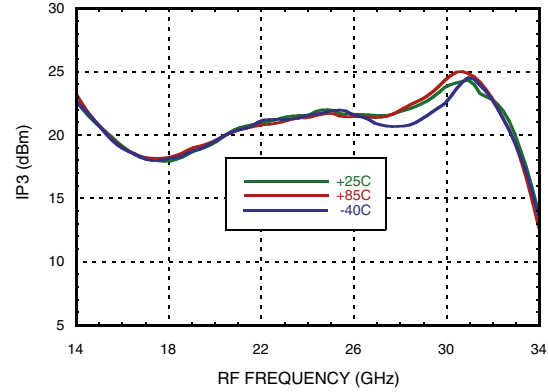

Input IP3, LSB vs LO Drive

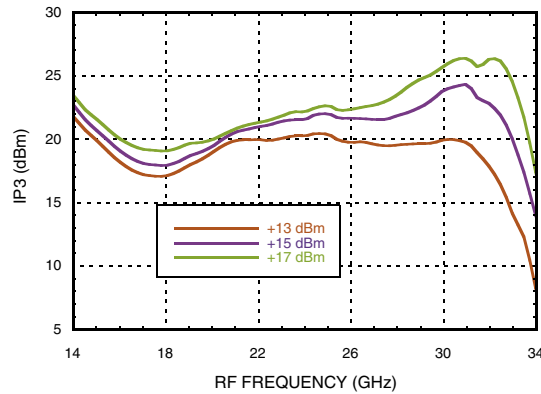



Data Taken As IRM with External IF 90° Hybrid, IF = 2500 MHz

Conversion Gain, USB vs. Temperature

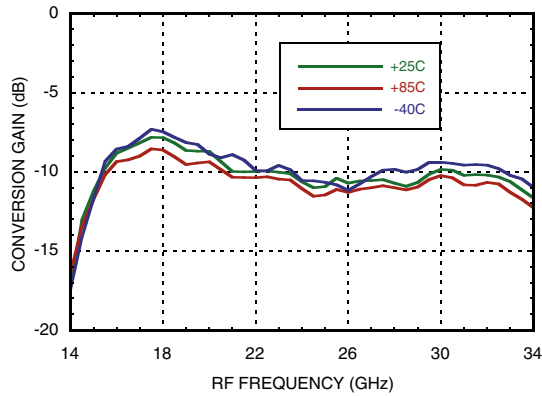

Conversion Gain, USB vs. LO Drive

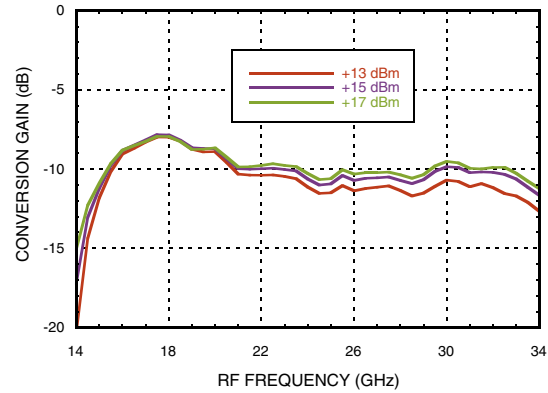

Image Rejection, USB vs. Temperature

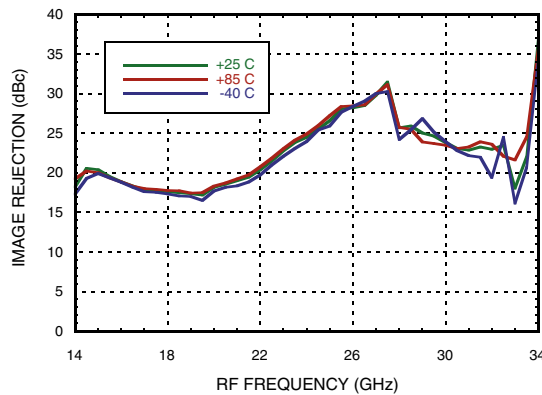
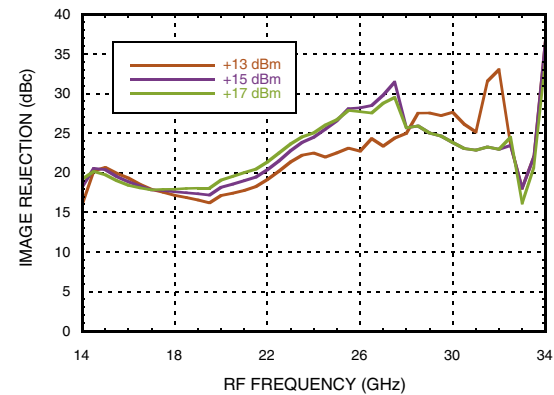
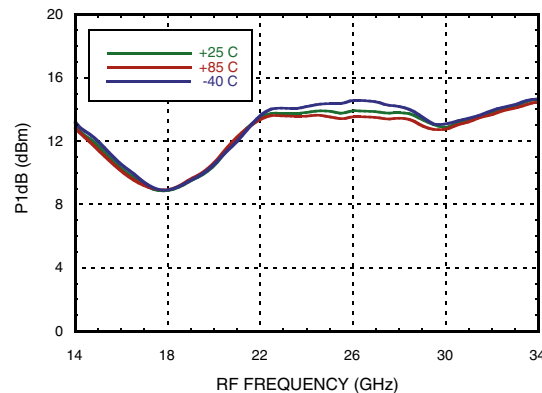

Image Rejection, USB vs. LO Drive



Input P1dB, USB vs. Temperature



Input IP3, USB vs. Temperature

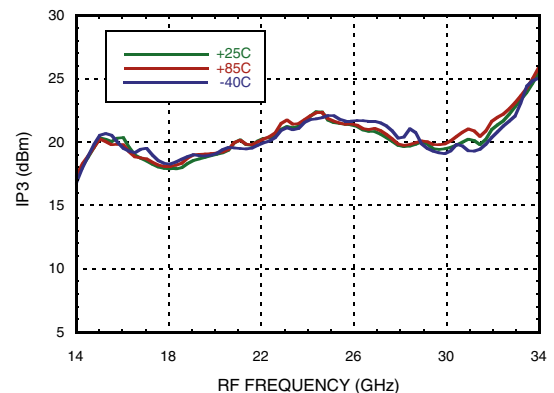



Data Taken As IRM with External IF 90° Hybrid, IF = 2500 MHz

Input IP3, USB vs. Temperature

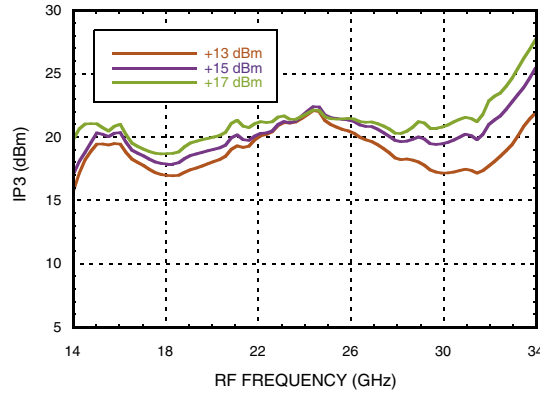

Conversion Gain, LSB vs. Temperature

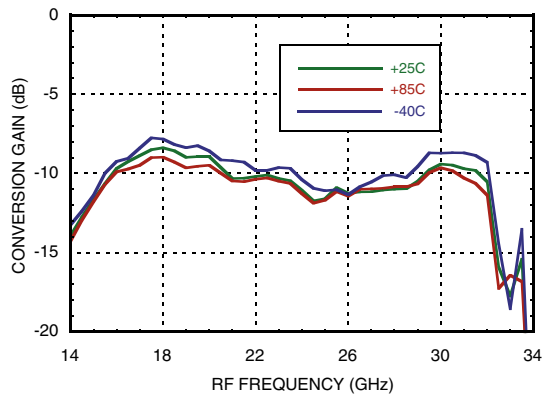

Conversion Gain, LSB vs. LO Drive

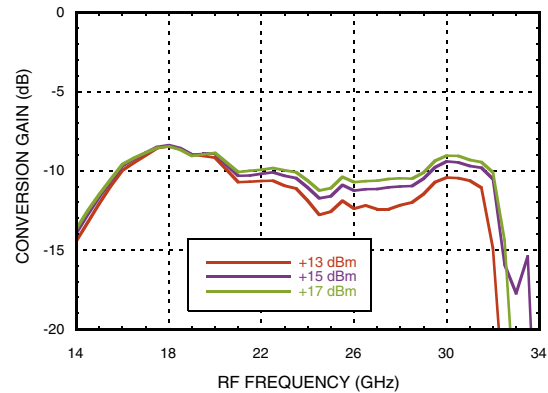

Image Rejection, LSB vs. Temperature

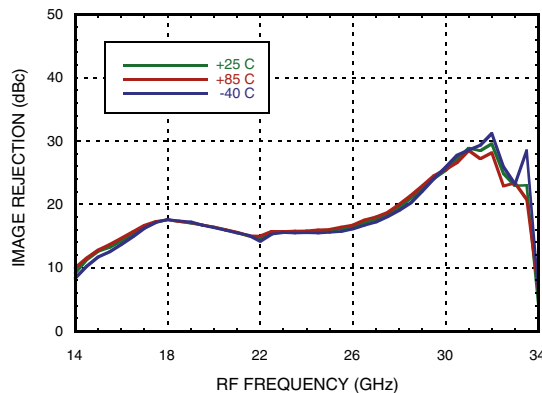
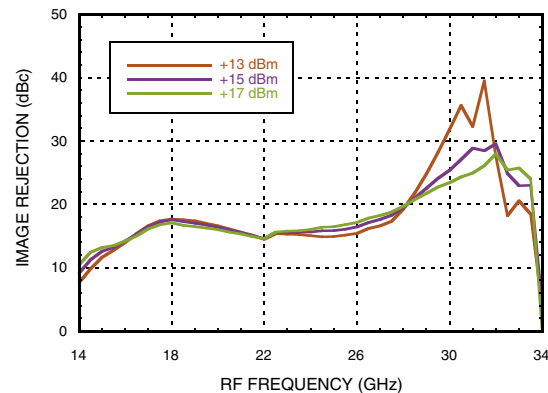

Image Rejection, LSB vs. LO Drive





Data Taken As IRM with External IF 90° Hybrid, IF = 2500 MHz

Input P1dB, LSB vs. Temperature

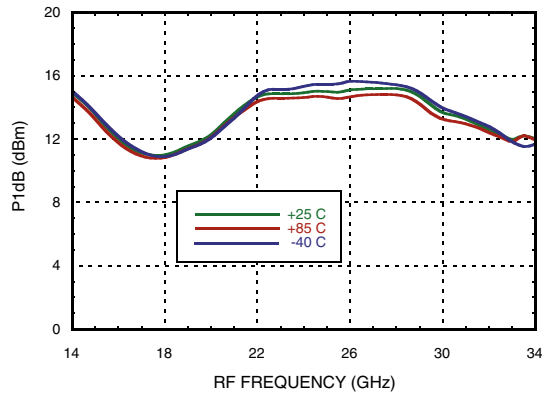

Input IP3, LSB vs. Temperature

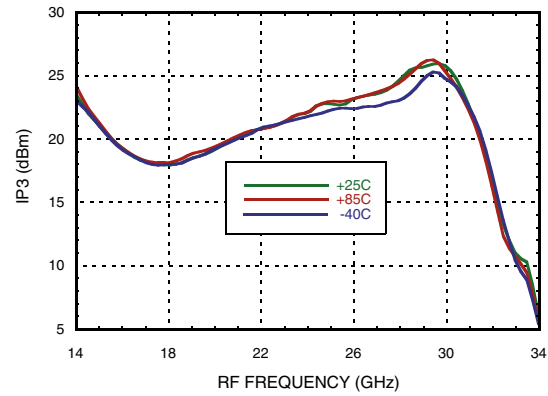

Input IP3, LSB vs LO Drive

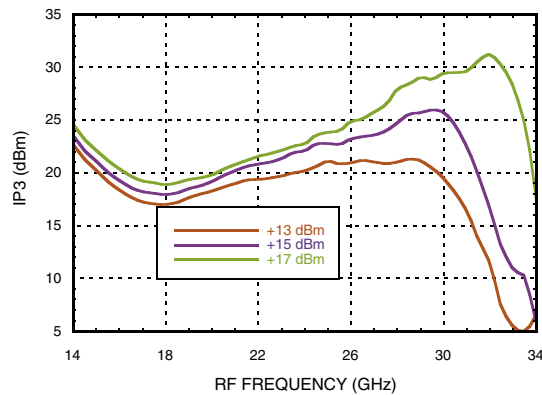



Harmonics of LO

LO Freq. (GHz)	nLO Spur at RF Port		
	1	2	3
13	43	40	45
18	41	50	X
23	44	44	X
28	44	X	X
33	36	X	X

LO = + 15 dBm
Values in dBc below LO level measured at RF Port.

MxN Spurious Outputs

mRF	nLO				
	0	1	2	3	4
0		14	34	25	X
1	21	X	38	58	66
2	81	82	63	64	85
3	67	79	84	82	88
4	X	65	76	85	89

RF = 25 GHz @ -10 dBm
LO = 23 GHz @ +11 dBm
Data taken without IF hybrid
All values in dBc below IF power level

Absolute Maximum Ratings

RF / IF Input (LO = +18 dBm)	+18dBm
LO Drive	+20 dBm
Channel Temperature	150°C
Continuous Pdiss (T=85°C) (derate 5.0 mW/°C above 85°C)	328 mW
Thermal Resistance (R _{TH}) (junction to package bottom)	198°C/W
Storage Temperature	-65 to +125 °C
Operating Temperature	-40 to +85 °C
ESD Sensitivity (HBM)	Class 1A

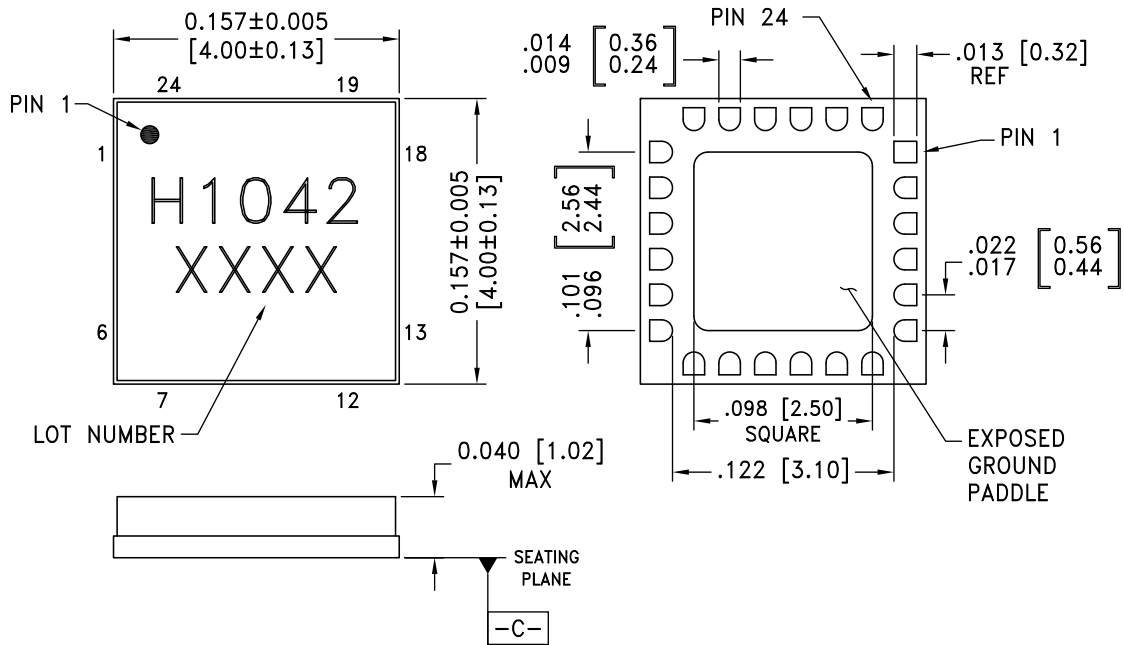

**ELECTROSTATIC SENSITIVE DEVICE
OBSERVE HANDLING PRECAUTIONS**

Outline Drawing
BOTTOM VIEW

NOTES:

1. PACKAGE BODY MATERIAL: ALUMINA.
2. LEAD AND GROUND PADDLE PLATING: GOLD FLASH OVER NICKEL.
3. DIMENSIONS ARE IN INCHES (MILLIMETERS).
4. LEAD SPACING TOLERANCE IS NON-CUMULATIVE.
5. PACKAGE WARP SHALL NOT EXCEED 0.05MM DATUM [-C-]
6. ALL GROUND LEADS AND GROUND PADDLE MUST BE SOLDERED TO PCB RF GROUND.

Package Information



Part Number	Package Body Material	Lead Finish	MSL Rating	Package Marking ^[2]
HMC1042LC4	Alumina, White	Gold over Nickel	MSL1 ^[1]	H1042 XXXX

[1] Max peak reflow temperature of 260 °C

[2] 4-Digit lot number XXXX

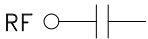
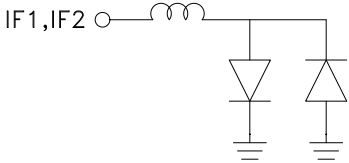

Pin Descriptions

Pin Number	Function	Description	Interface Schematic
1, 2, 6, 7, 10, 12, 13, 17-24	N/C	These pins are not connected internally; however, all data shown herein was measured with these pins connected to RF/DC ground externally.	
3, 5, 8, 14, 16	GND	These pins and the exposed ground paddle must be connected to RF/DC ground.	
4	RF	This pin is AC coupled and matched to 50 Ohms.	
9	IF2	This pin is DC coupled. For application not requiring operation to DC, this port should be DC blocked externally using a series capacitor whose value has been chosen to pass the necessary IF frequency range. For operation to DC, this pin must not source/sink more than 3 mA of current or product non-function and possible product failure will result.	
11	IF1		
15	LO	This pin is AC coupled and matched to 50 Ohms from 15 to 33.5 GHz	

Evaluation PCB

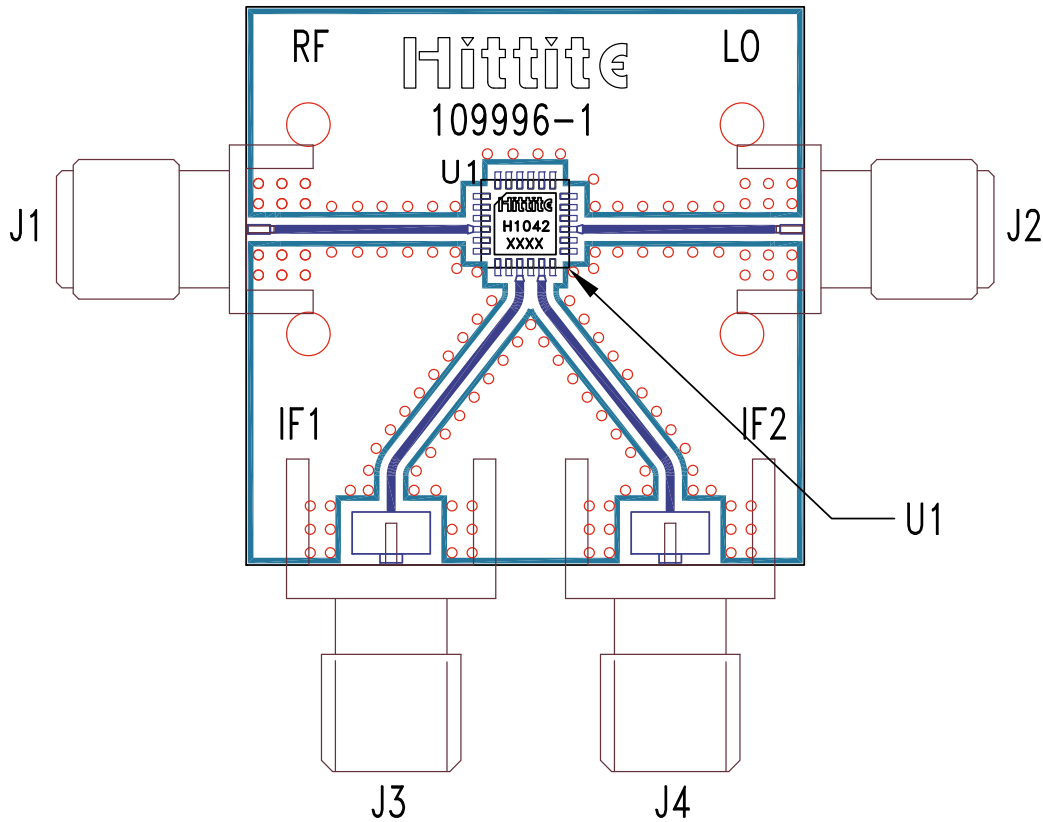

List of Materials for Evaluation PCB EVAL01-HMC1042LC4 ^[1]

Item	Description
J1, J2	PCB Mount SMA RF Connector, SRI
J3 - J4	PCB Mount SMA Connector, Johnson
U1	HMC1042LC4
PCB ^[2]	109996-1 Evaluation Board

^[1] Reference this number when ordering complete evaluation PCB

^[2] Circuit Board Material: Rogers 4350

The circuit board used in the application should use RF circuit design techniques. Signal lines should have 50 Ohm impedance while the package ground leads and exposed paddle should be connected directly to the ground plane similar to that shown. A sufficient number of via holes should be used to connect the top and bottom ground planes. The evaluation circuit board shown is available from Hittite upon request.



Notes