

Typical Applications

Prescaler for DC to X Band PLL Applications:

- Point-to-Point / Multi-Point Radios
- VSAT Radios
- Test Equipment
- Fiber Optic
- Military & Space

Features

- Ultra Low SSB Phase Noise: -153 dBc/Hz
- Wide Bandwidth
- Output Power: 4 dBm
- Single DC Supply: +5V
- 8 Lead Hermetic SMT Package

Functional Diagram

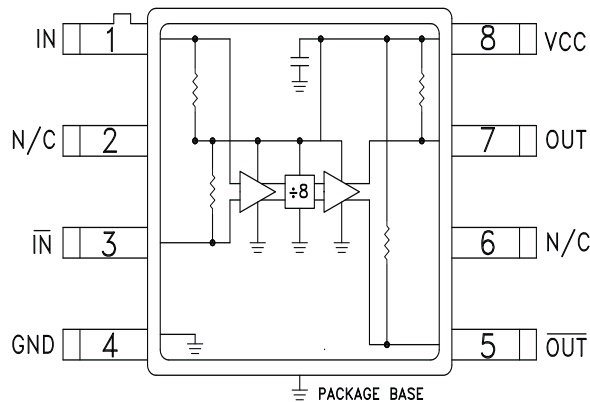

General Description

The HMC363G8 is a low noise Divide-by-8 Static Divider with InGaP GaAs HBT technology in an 8 lead glass/metal (hermetic) surface mount package. This device operates from DC (with a square wave input) to 12 GHz input frequency with a single +5V DC supply. The low additive SSB phase noise of -153 dBc/Hz at 100 kHz offset helps the user maintain good system noise performance.

Electrical Specifications, $T_A = +25^\circ\text{C}$, 50 Ohm System, $V_{CC} = 5V$

| Parameter | Conditions | Min. | Typ. | Max. | Units |
|----------------------------------|---------------------------------------|------|------|------|--------|
| Maximum Input Frequency | | 12 | 13 | | GHz |
| Minimum Input Frequency | Sine Wave Input. [1] | | 0.2 | 0.5 | GHz |
| Input Power Range | $F_{in} = 1$ to 6 GHz | -15 | >-20 | +10 | dBm |
| | $F_{in} = 6$ to 8 GHz | -15 | >-20 | +5 | dBm |
| | $F_{in} = 8$ to 12 GHz | -10 | >-15 | 0 | dBm |
| Output Power | $F_{in} = 12$ GHz | 1 | 4.0 | | dBm |
| Reverse Leakage | Both RF Outputs Terminated | | 55 | | dB |
| SSB Phase Noise (100 kHz offset) | $P_{in} = 0$ dBm, $F_{in} = 6$ GHz | | -153 | | dBc/Hz |
| Output Transition Time | $P_{in} = 0$ dBm, $F_{out} = 882$ MHz | | 100 | | ps |
| Supply Current (I_{CC}) | | | 90 | | mA |

1. Divider will operate down to DC for square-wave input signal.

**SMT GaAs HBT MMIC
DIVIDE-BY-8, DC - 12 GHz**

Input Sensitivity Window, $T = 25\text{ }^{\circ}\text{C}$

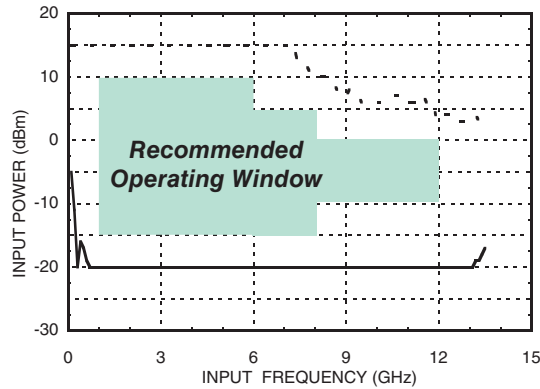

Input Sensitivity Window vs. Temperature

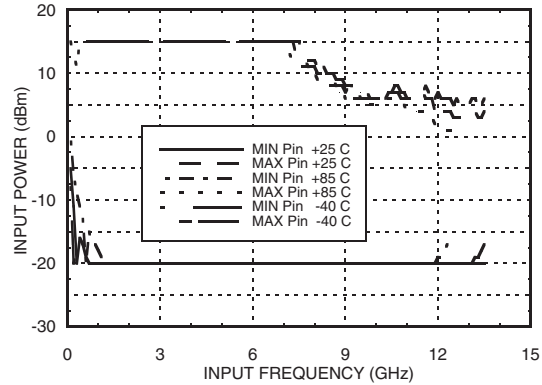

Output Power vs. Temperature

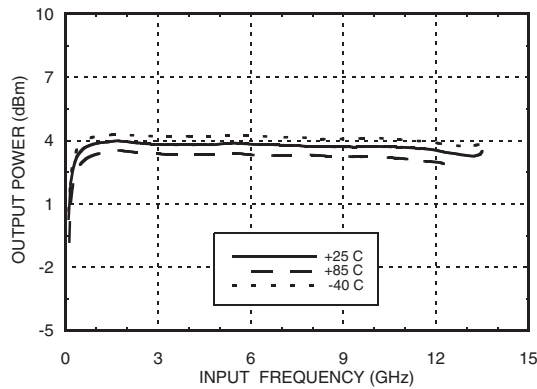

SSB Phase Noise

Performance, $P_{in} = 0\text{ dBm}$, $T = 25\text{ }^{\circ}\text{C}$

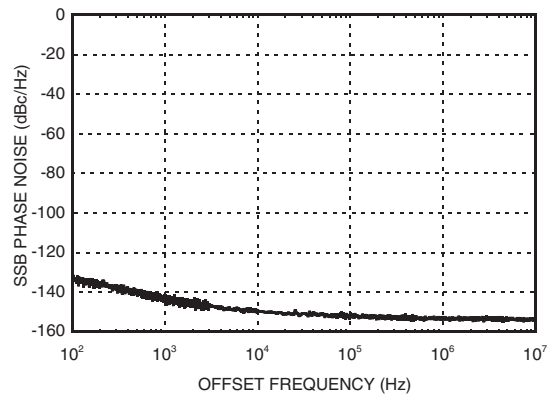

Output Harmonic

Content, $P_{in} = 0\text{ dBm}$, $T = 25\text{ }^{\circ}\text{C}$

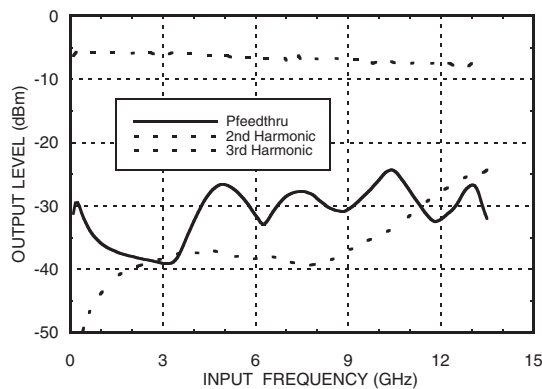

Reverse Leakage, $P_{in} = 0\text{ dBm}$, $T = 25\text{ }^{\circ}\text{C}$

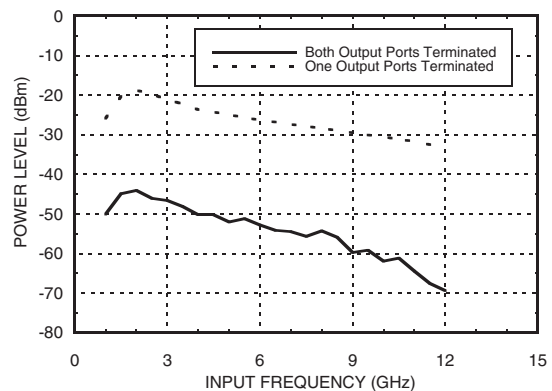

SMT GaAs HBT MMIC DIVIDE-BY-8, DC - 12 GHz

Output Voltage Waveform,
Pin= 0 dBm, Fout= 882 MHz, T= 25 °C

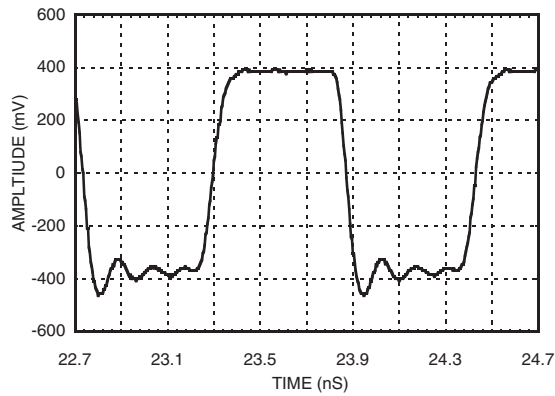

Absolute Maximum Ratings

| | |
|---|----------------|
| RF Input (Vcc = +5V) | +13 dBm |
| Vcc | +5.5V |
| Channel Temperature (Tc) | 135 °C |
| Continuous Pdiss (T= 85 °C) (derate 12.2 mW/ °C above 85 °C) | 609 mW |
| Storage Temperature | -65 to +150 °C |
| Operating Temperature | -40 to +85 °C |
| Thermal Resistance (junction to ground paddle) | 82 °C/W |



**ELECTROSTATIC SENSITIVE DEVICE
OBSERVE HANDLING PRECAUTIONS**

Typical Supply Current vs. Vcc

| Vcc (V) | Icc (mA) |
|---------|----------|
| 4.75 | 85 |
| 5.0 | 90 |
| 5.25 | 100 |

Note: Divider will operate over full voltage range shown above

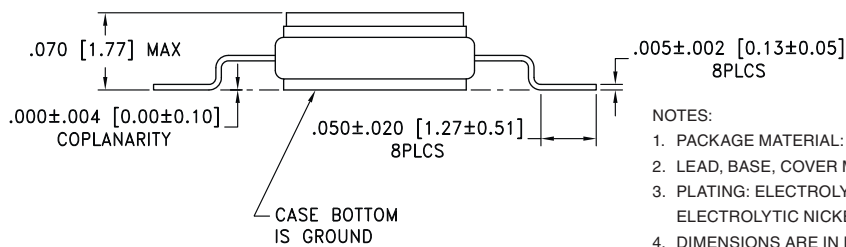
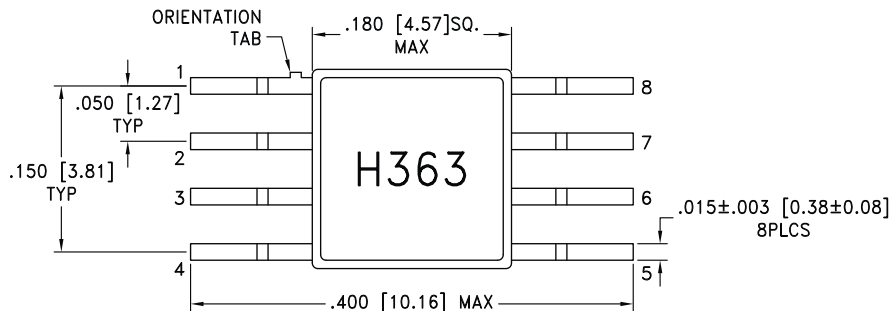

Outline Drawing



NOTES:

1. PACKAGE MATERIAL: ALUMINA LOADED BOROSILICATE GLASS.
2. LEAD, BASE, COVER MATERIAL: KOVAR™ (#7052 CORNING).
3. PLATING: ELECTROLYTIC GOLD 50 MICROINCHES MIN., OVER ELECTROLYTIC NICKEL 50 MICROINCHES MIN.
4. DIMENSIONS ARE IN INCHES [MILLIMETERS].
5. TOLERANCES: ±.005 [0.13] UNLESS OTHERWISE SPECIFIED.
6. ALL GROUND LEADS AND GROUND PADDLE MUST BE SOLDERED TO PCB RF GROUND.

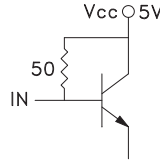
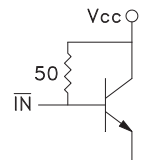
Pin Description

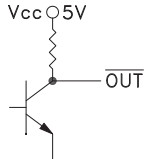
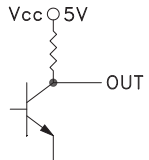
| Pin Number | Function | Description | Interface Schematic |
|------------|-------------------------|--|---|
| 1 | $\overline{\text{IN}}$ | RF Input must be DC blocked. |  |
| 2, 6 | N/C | No connection. | |
| 3 | IN | RF Input 180° out of phase with pin 1 for differential operation. AC ground for single ended operation. |  |
| 4 | GND | Ground: Backside of package has exposed metal ground which must be connected to a RF/DC ground. |  |
| 5 | $\overline{\text{OUT}}$ | Divided output 180° out of phase with pin 7. |  |
| 7 | OUT | Divided Output. |  |
| 8 | VCC | Supply voltage 5V ± 0.25V. | |

Evaluation PCB

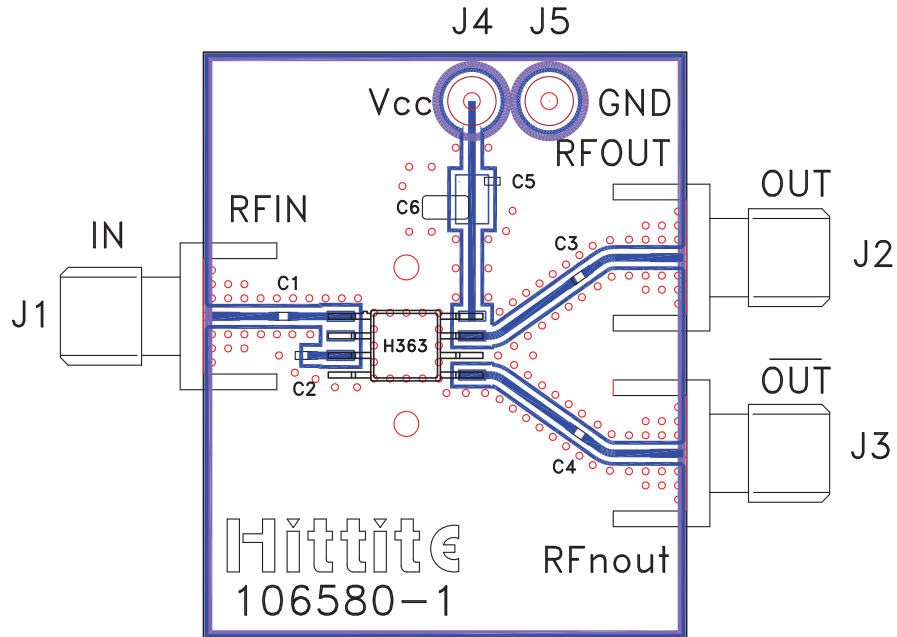

List of Materials for Evaluation PCB 106582 [1]

| Item | Description |
|---------|-------------------------------|
| J1 - J3 | PCB Mount SMA RF Connector |
| C1 - C4 | 100 pF Capacitor, 0402 Pkg. |
| C5 | 1000 pF Capacitor, 0603 Pkg. |
| C6 | 10 μ F Tantalum Capacitor |
| U1 | HMC363G8 Divide-by-8 |
| PCB [2] | 106580 Eval Board |

[1] Reference this number when ordering complete evaluation PCB

[2] Circuit Board Material: Rogers 4350

The circuit board used in the final application should use RF circuit design techniques. Signal lines should have 50 ohm impedance while the package ground leads and backside ground slug should be connected directly to the ground plane similar to that shown. A sufficient number of via holes should be used to connect the top and bottom ground planes. The evaluation circuit board shown is available from Hittite upon request. This evaluation board is designed for single ended input testing. J2 and J3 provide differential output signals.

Application Circuit

