



CELLULAR HIGH IP3 RFIC DOWNCONVERTER, 0.8 - 1.0 GHz

Typical Applications

The HMC377QS16G / HMC377QS16GE is ideal for:

- GSM & CDMA Infrastructure
- GPRS & EDGE Infrastructure
- Wireless Data/CDPD

Features

- +15 dBm Input IP3, +29 dBm Output IP3
- Low LO Drive: -5 dBm LO
- Conversion Gain: 14 dB
- Noise Figure: 11 dB
- Positive Supply: +5V @ 135 mA

Functional Diagram

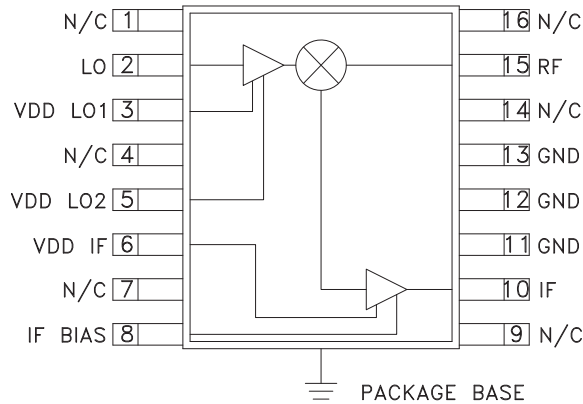

General Description

The HMC377QS16G & HMC377QS16GE are linear downconverter receiver ICs suitable for cellular infrastructure applications from 0.8 - 1.0 GHz. An integrated mixer coupled with a high dynamic range IF amplifier achieves an input intercept point (IP3) of +15 dBm, and an input P1dB of +3.5 dBm. The converter provides a gain of 13.5 dB and only 11 dB typical single side band noise figure. The IC operates from a positive +5V rail consuming 135 mA of current while requiring only -5 dBm LO drive. The design requires no external baluns. The mixer supports IF frequencies between 50 MHz and 250 MHz.

Electrical Specifications, $T_A = +25^\circ C$, LO = -5 dBm, IF = 70 MHz, Vdd = 5V

Parameter	Min.	Typ.	Max.	Units
Frequency Range, RF	0.8 - 1.0			GHz
Frequency Range, LO	0.55 - 1.15			GHz
Frequency Range, IF *	50 - 250			MHz
Conversion Gain	11	14		dB
Noise Figure (SSB)		11		dB
LO to RF Isolation	23	28		dB
LO to IF Isolation	63	70 - 75		dB
RF to IF Isolation	83	90 - 95		dB
IP3 (Input)	12	15		dBm
1 dB Compression (Input)	+0.5	+3.5		dBm
LO Input Drive Level (Typical)	-10 to 0			dBm
Supply Current (Idd for IF + LO)		135		mA

* IF matching must be tuned for optimal results. See application circuit herein.

**CELLULAR HIGH IP3 RFIC
DOWNCONVERTER, 0.8 - 1.0 GHz**



**Conversion Gain
vs. Temperature @ LO= -5 dBm**

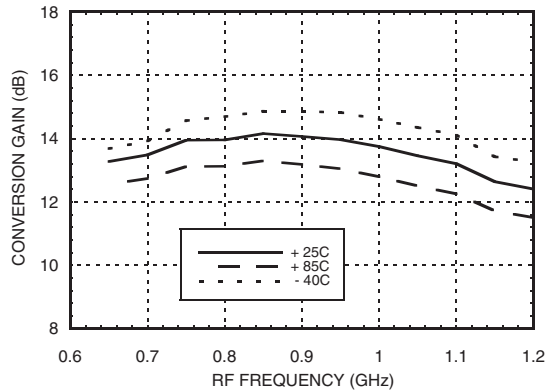

Isolation @ LO= -5 dBm

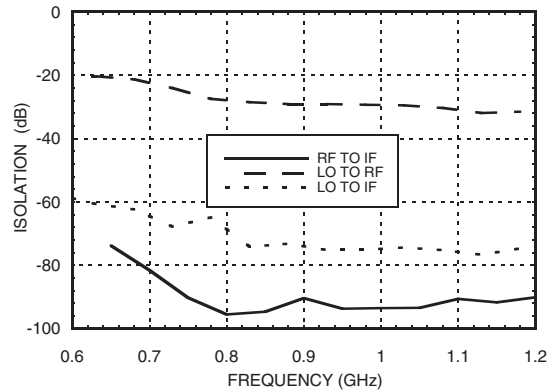

Conversion Gain vs. LO Drive

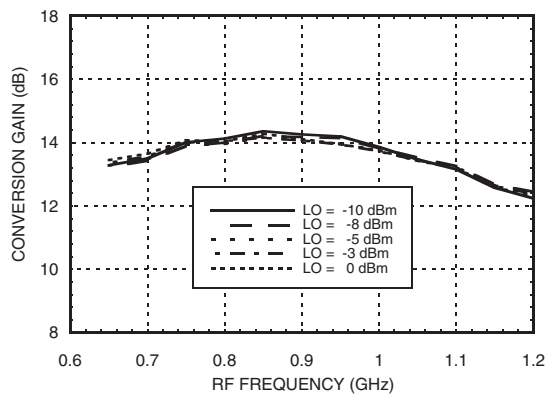

Return Loss @ LO= -5 dBm

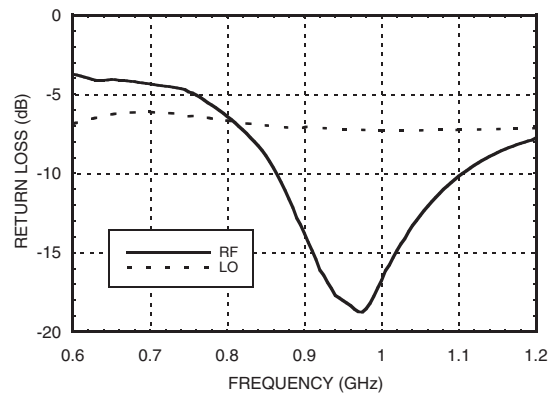

Conversion Gain vs. Vdd @ LO= -5 dBm

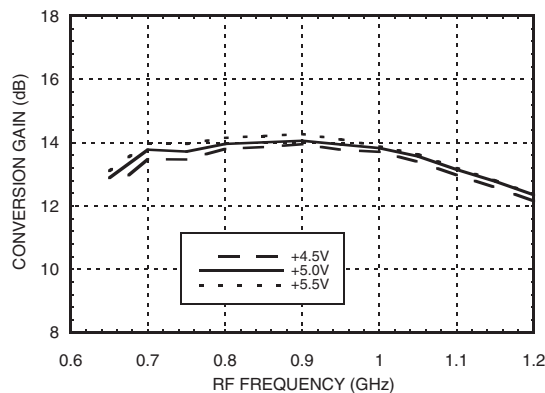

CELLULAR HIGH IP3 RFIC DOWNCONVERTER, 0.8 - 1.0 GHz



**Input P1dB vs.
Temperature @ LO= -5 dBm**

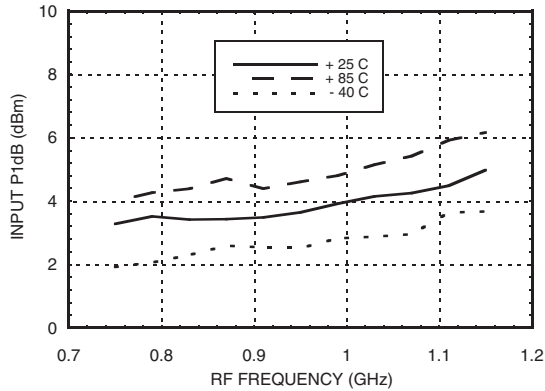

Input P1dB vs. Vdd @ LO= -5 dBm

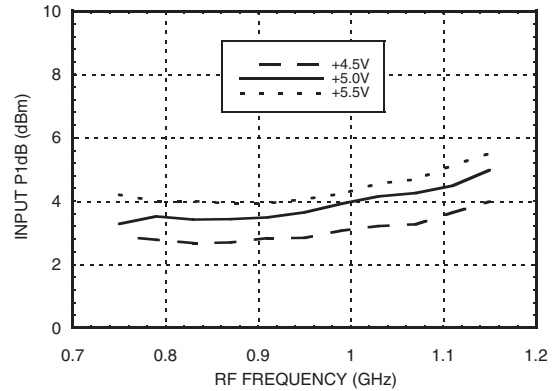

**Input and Output
IP3 vs. Temperature @ LO= -5 dBm**

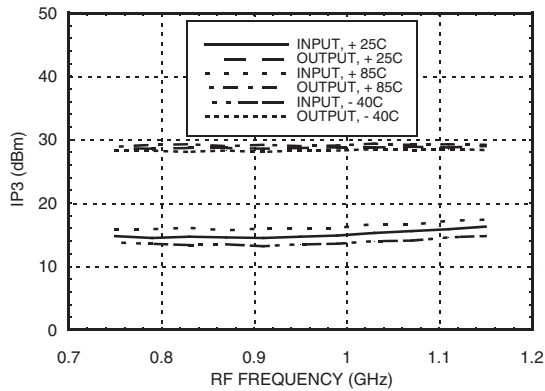

Input and Output IP3 vs. LO Drive

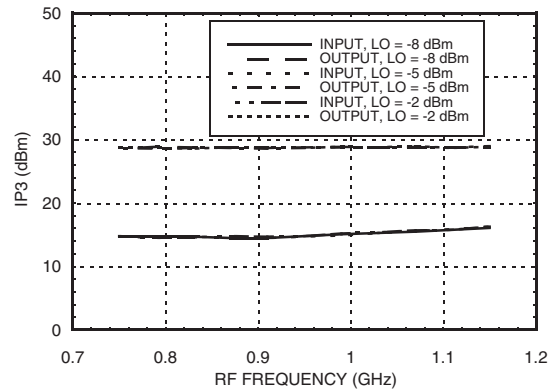

**Input and Output
IP3 vs. Vdd @ LO= -5 dBm**

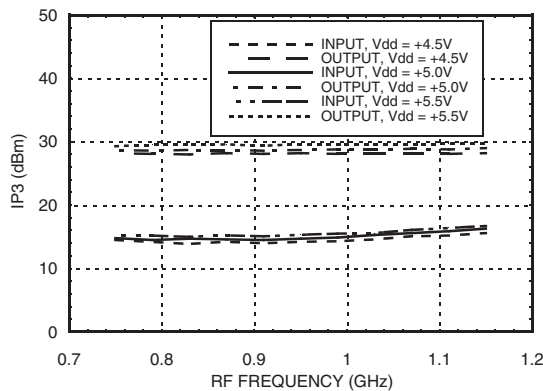



CELLULAR HIGH IP3 RFIC DOWNCONVERTER, 0.8 - 1.0 GHz

**Noise Figure vs. Temperature,
Swept LO, Fixed IF= 70 MHz**

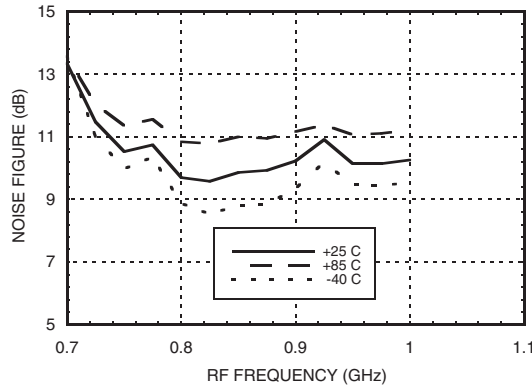

Noise Figure Swept IF, Fixed LO

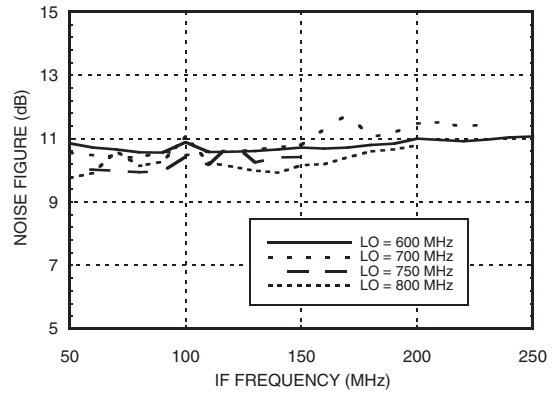

**IF Return Loss
@ Various Tuned IF Frequencies**

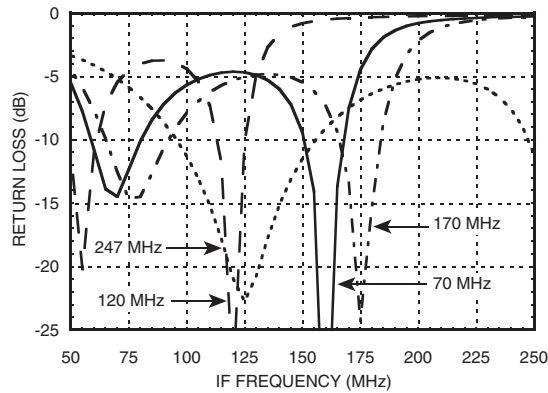

**IF Bandwidth
@ Various Tuned IF Frequencies**

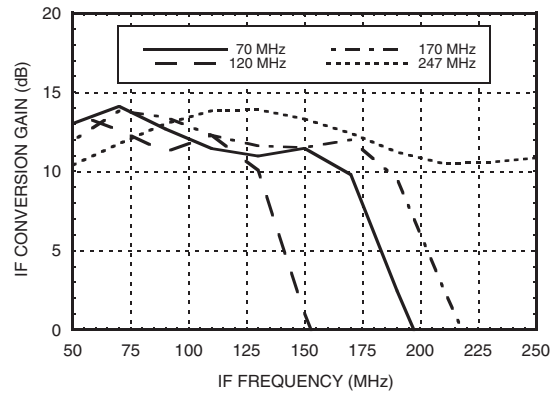

MxN Spurious @ IF Port

mRF	nLO				
	0	1	2	3	4
0	xx	79	95	93	94
1	94	0	95	95	95
2	95	95	44	95	95
3	95	95	95	84	95
4	94	94	94	95	94

RF Freq.= 0.9 GHz @ -10 dBm
LO Freq.= 0.83 GHz @ -5 dBm
All values in dBc relative to the IF power level.

Harmonics of LO

LO Freq. (GHz)	nLO Spur @ RF Port			
	1	2	3	4
0.7	22	9	34	26
0.75	26	11	31	30
0.8	28	13	32	33
0.85	29	15	32	36
0.9	29	16	33	49
0.95	29	17	34	45

LO= -5 dBm
Values in dBc below input LO level measured at RF port.

* Refer to HMC420QS16 Application Circuit herein for IF port tuning information.

CELLULAR HIGH IP3 RFIC DOWNCONVERTER, 0.8 - 1.0 GHz

Absolute Maximum Ratings

RF / IF Input (Vdd= +5V)	+13 dBm
LO Drive (Vdd= +5V)	+15 dBm
Vdd (LO or IF)	+7 Vdc
Channel Temperature	150°C
Continuous Pdiss (T = 85°C) (derate 17.4 mW/°C above 85°C)	0.881 W
Thermal Resistance (R _{TH}) (junction to lead)	57.3 °C/W
Storage Temperature	-65 to +150 °C
Operating Temperature	-40 to +85 deg °C

Typical Supply Current vs. Vdd

Vdd (Vdc) (LO & IF)	Idd (mA)
4.5	115
5.0	135
5.5	155

Downconverter will operate over above supply range.



**ELECTROSTATIC SENSITIVE DEVICE
OBSERVE HANDLING PRECAUTIONS**

Outline Drawing

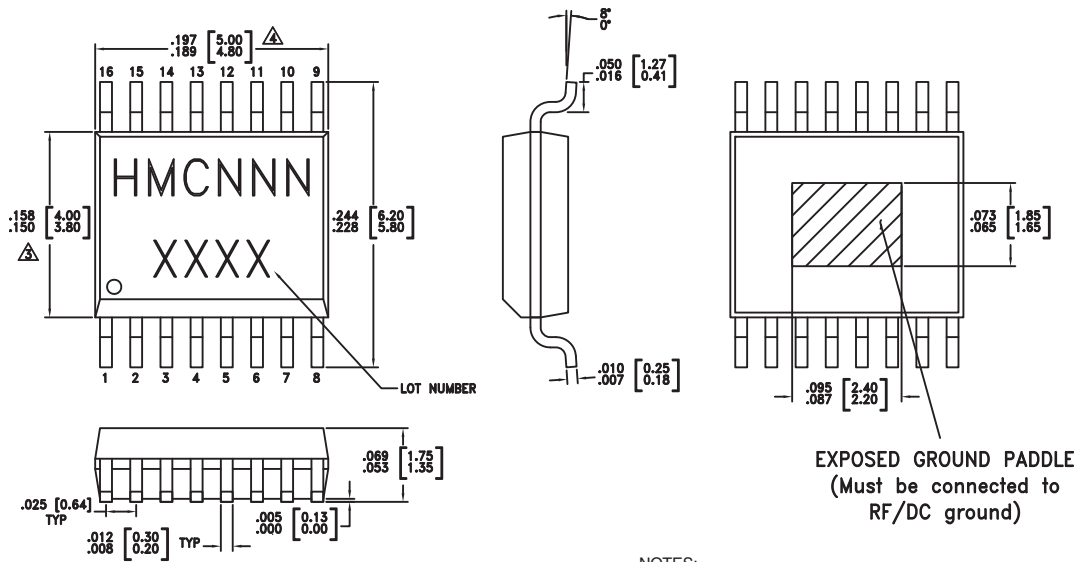

NOTES:

- LEADFRAME MATERIAL: COPPER ALLOY
- DIMENSIONS ARE IN INCHES [MILLIMETERS].
- DIMENSION DOES NOT INCLUDE MOLDFLASH OF 0.15mm PER SIDE.
- DIMENSION DOES NOT INCLUDE MOLDFLASH OF 0.25mm PER SIDE.
- ALL GROUND LEADS AND GROUND PADDLE MUST BE SOLDERED TO PCB RF GROUND.

Package Information

Part Number	Package Body Material	Lead Finish	MSL Rating	Package Marking ^[3]
HMC377QS16G	Low Stress Injection Molded Plastic	Sn/Pb Solder	MSL1 ^[1]	HMC377 XXXX
HMC377QS16GE	RoHS-compliant Low Stress Injection Molded Plastic	100% matte Sn	MSL1 ^[2]	HMC377 XXXX

[1] Max peak reflow temperature of 235 °C

[2] Max peak reflow temperature of 260 °C

[3] 4-Digit lot number XXXX

For price, delivery, and to place orders, please contact Hittite Microwave Corporation:
20 Alpha Road, Chelmsford, MA 01824 Phone: 978-250-3343 Fax: 978-250-3373
Order On-line at www.hittite.com

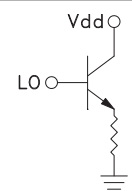
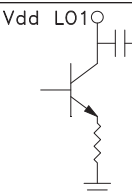
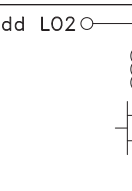
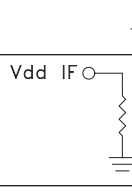
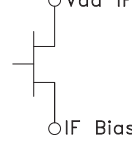
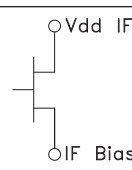
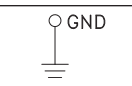
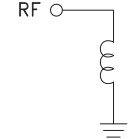

Pin Descriptions

Pin Number	Function	Description	Interface Schematic
1, 4, 7, 9, 14, 16	N/C	No Connection. These pins may be connected to RF ground. Performance will not be affected.	
2	LO	This pin is DC coupled and matched to 50 Ohms from 0.8 - 1.0 GHz. An external series capacitor (100 pF) (C9) is required.	
3	Vdd LO 1	Power Supply for the LO amplifier, An external 56 nH series inductor (L3) with 22 Ohm series bias resistor (R2) and an RF bypass capacitor (C8) are required.	
5	Vdd LO 2	Power supply for the LO amplifier. One external RF bypass capacitor (10,000 pF) (C3) is required.	
6	Vdd IF	Bias voltage for IF amplifier. One external RF bypass capacitor (10,000 pF) (C2) is required.	
8	IF Bias	DC bias setting for IF amplifier. (C1, R1)	
10	IF	Output of IF and bias port for amplifier. A pull up inductor (L1), output matching network (C5, C6, C7, L2, L4), and 10,000 pF bypass capacitor (C4) are required.	
11, 12, 13	GND	Pin must connect to RF ground. Backside of package has exposed metal ground slug that must also be connected to RF/DC ground.	
15	RF	This pin is DC coupled and matched to 50 Ohms from 0.8 - 1.0 GHz.	



Evaluation PCB

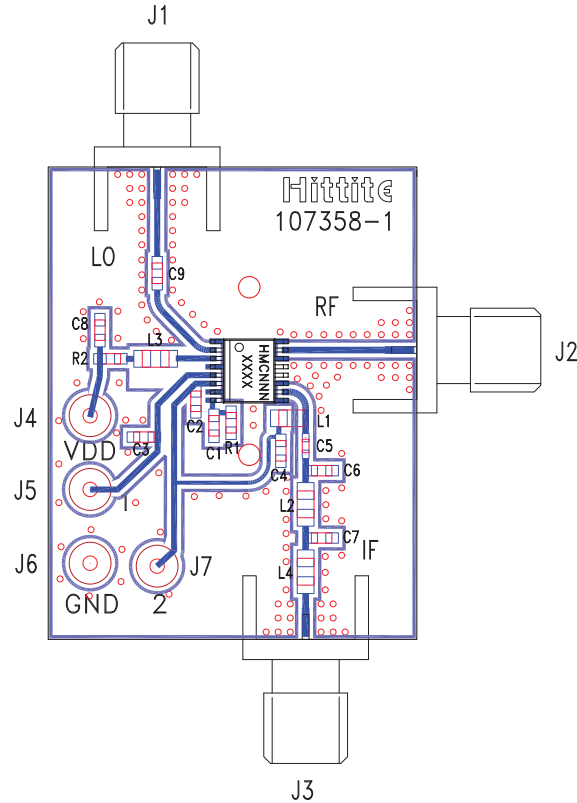

List of Materials for Evaluation PCB 107360 [1]

Item	Description
J1, J2, J3	PCB Mount SMA RF Connector
J4, J5, J6, J7	DC Pins
C1	1000 pF Chip Capacitor, 0603 Pkg.
C2, C3, C4, C8	0.01µF Chip Capacitor, 0603 Pkg.
C5	82 pF Chip Capacitor, 0402 Pkg.
C6, C7 [3]	33 pF Chip Capacitor, 0603 Pkg.
C9	100 pF Chip Capacitor, 0602 Pkg.
L1	150 nH Chip Inductor, 0805 Pkg.
L2, L4	68 nH Chip Inductor, 0805 Pkg.
L3	56 nH Inductor, 0805 Pkg.
R1	3.3 Ohm Resistor, 0603
R2	22 Ohm Resistor, 0603 Pkg.
U1	HMC377QS16G / HMC377QS16GE Mixer
PCB [2]	107358 Evaluation Board

The circuit board used in the final application should use RF circuit design techniques. Signal lines should have 50 ohm impedance while the package ground leads should be connected directly to the ground plane similar to that shown. A sufficient number of via holes should be used to connect the top and bottom ground planes. The evaluation circuit board shown is available from Hittite upon request.

[1] Reference this number when ordering complete evaluation PCB

[2] Circuit Board Material: Rogers 4350

[3] For 70 MHz IF. See Application Circuit for alternate IF frequency tuning.

Application Circuit

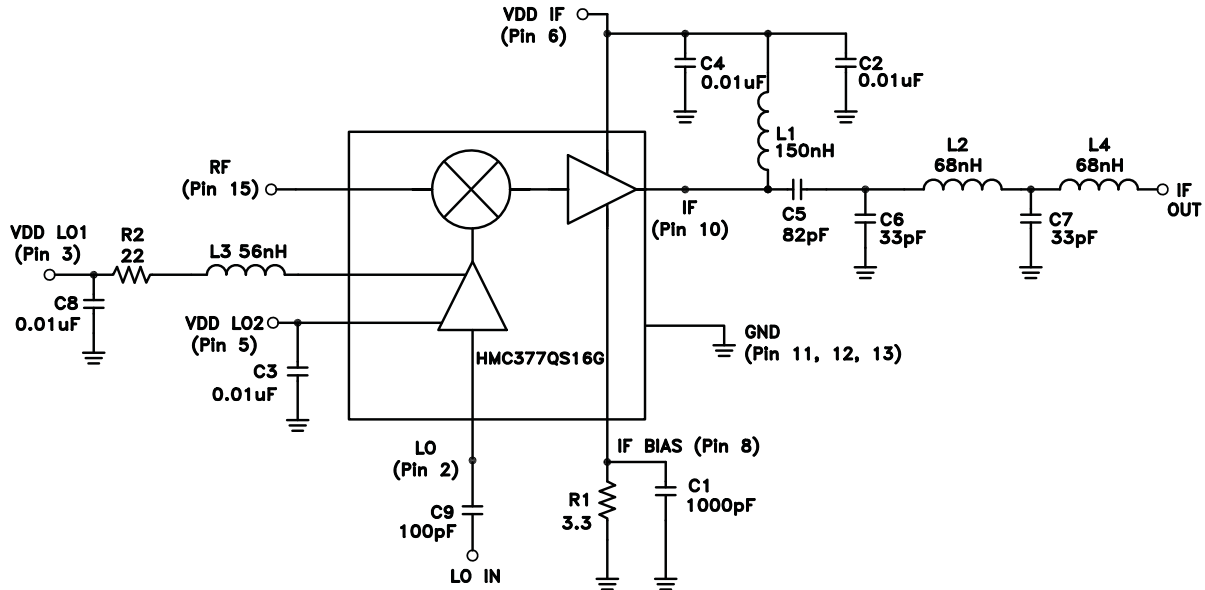

Note: Pins 3, 5 and 6 may be connected to a common Vdd Supply.

**Selection of C6 & C7
For Various Tuned IF Frequencies**

IF	C6, C7
70 MHz	150 pF
120 MHz	56 pF
170 MHz	27 pF
247 MHz	12 pF