

Typical Applications

The HMC382LP3 / HMC382LP3E is ideal for:

- Cellular/3G Infrastructure
- Base Stations & Repeaters
- CDMA, W-CDMA, & TD-SCDMA
- GSM/GPRS & EDGE

Features

- Noise Figure: 1 dB
- Output IP3: +30 dBm
- Gain: 17 dB
- Externally Adjustable Supply Current
- Single Positive Supply: +5V
- 50 Ohm Matched Input/Output

Functional Diagram

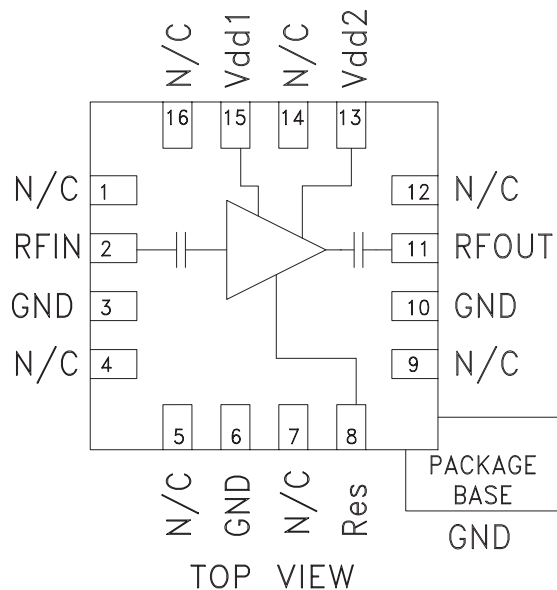

General Description

The HMC382LP3 & HMC382LP3E high dynamic range GaAs PHEMT MMIC Low Noise Amplifiers are ideal for GSM & CDMA cellular basestation front-end receivers operating between 1.7 and 2.2 GHz. This LNA has been optimized to provide 1.0 dB noise figure, 17 dB gain and +30 dBm output IP3 from a single supply of +5V. The HMC382LP3 & HMC382LP3E feature an externally adjustable supply current which allows the designer to tailor the linearity performance of the LNA for each application. For applications which require improved noise figure, please see the HMC618LP3(E).

Electrical Specifications, $T_A = +25^\circ C$, $V_{dd1}, V_{dd2} = +5V$, $R_{bias} = 16 \text{ Ohms}^*$

Parameter	Min.	Typ.	Max.	Min.	Typ.	Max.	Min.	Typ.	Max.	Min.	Typ.	Max.	Units
Frequency Range	1.7 - 1.9			1.9 - 2.0			2.0 - 2.1			2.1 - 2.2			GHz
Gain	14	17		12	15		11	14		9	12		dB
Gain Variation Over Temperature		0.01	0.015		0.01	0.015		0.01	0.015		0.01	0.015	dB/°C
Noise Figure		1.0	1.3		1.05	1.35		1.15	1.45		1.2	1.5	dB
Input Return Loss		13			12			11			10		dB
Output Return Loss		10			13			12			9		dB
Reverse Isolation		37			36			35			35		dB
Output Power for 1dB Compression (P1dB)		16			16			15.5			14		dBm
Output Third Order Intercept (IP3) (-20 dBm Input Power per tone, 1 MHz tone spacing)		29.5			30			30			29.5		dBm
Supply Current (I _{dd1} + I _{dd2})		67			67			67			67		mA

* R_{bias} resistor value sets current. See application circuit herein.



Broadband Gain & Return Loss

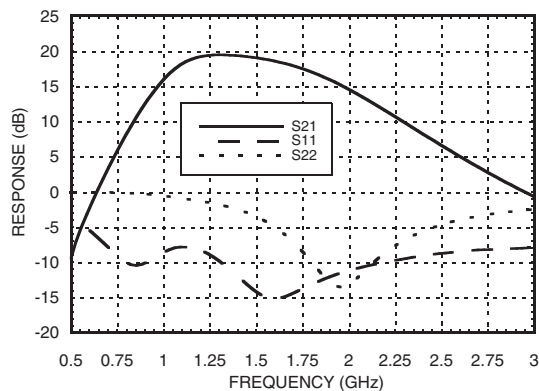

Gain vs. Temperature

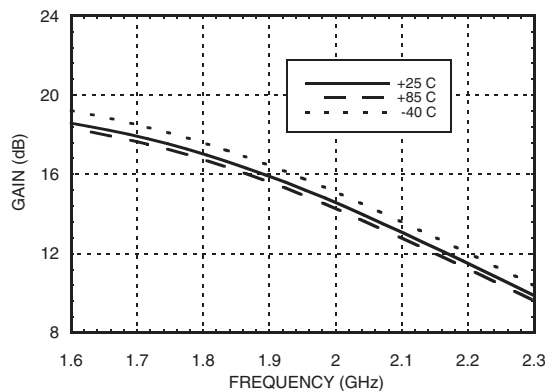

Input Return Loss vs. Temperature

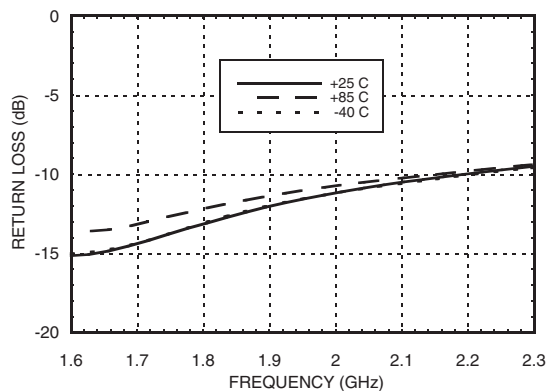

Output Return Loss vs. Temperature

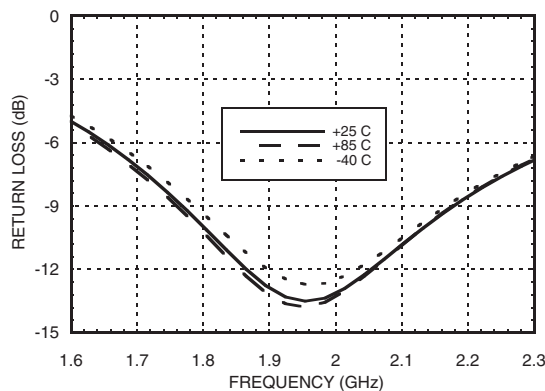

Reverse Isolation vs. Temperature

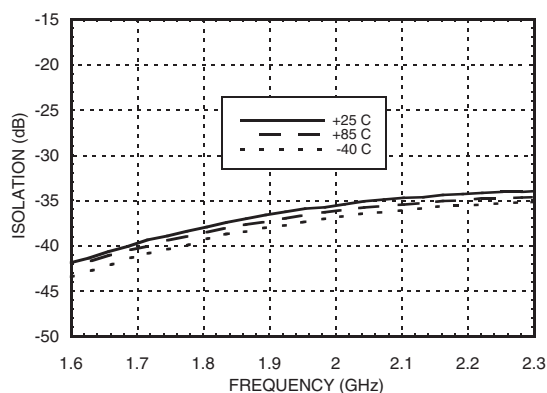

Noise Figure vs. Temperature

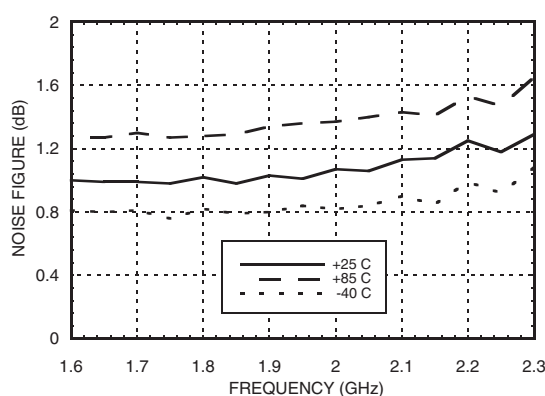

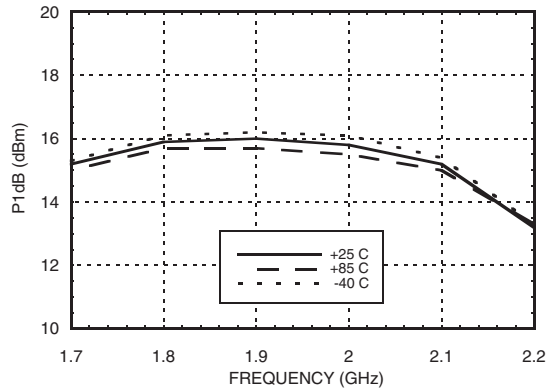
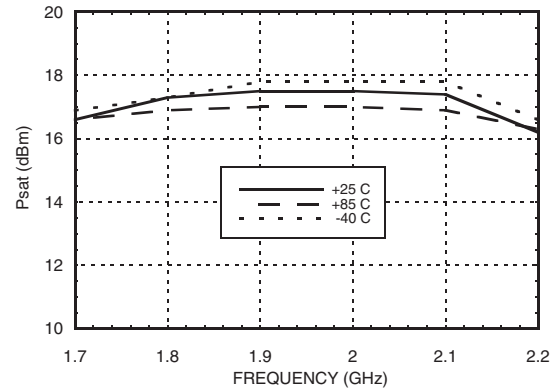
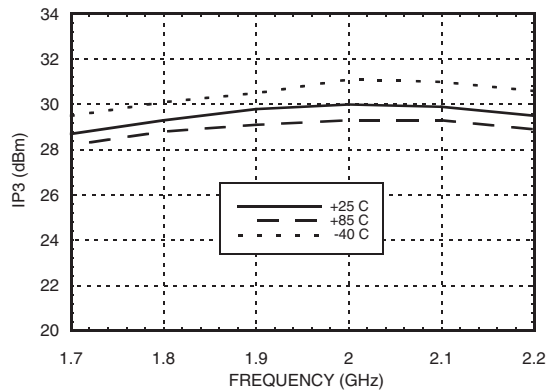
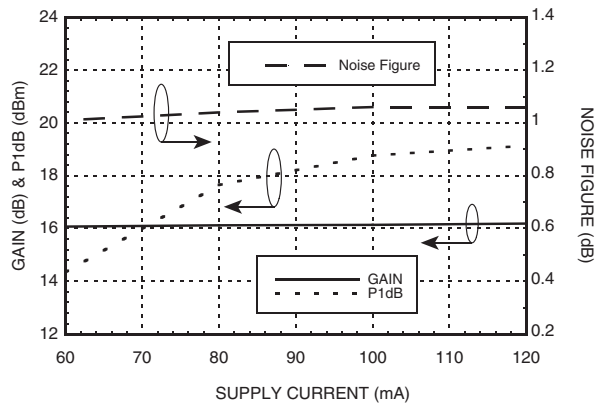
P1dB vs. Temperature @ Idd = 67 mA

Psat vs. Temperature @ Idd = 67 mA

Output IP3 vs. Temperature Idd = @ 67 mA

**Gain, Noise Figure & P1dB vs.
Supply Current @ 1900 MHz**

Absolute Maximum Ratings

Drain Bias Voltage (Vdd1, Vdd2)	+8.0 Vdc
RF Input Power (RFIN)(Vs = +5.0 Vdc)	+10 dBm
Channel Temperature	150 °C
Continuous P _{diss} (T = 85 °C) (derate 6.94 mW/°C above 85 °C)	0.451 W
Thermal Resistance (channel to ground paddle)	144 °C/W
Storage Temperature	-65 to +150 °C
Operating Temperature	-40 to +85 °C

Typical Supply Current vs. Vdd1 & Vdd2

Vdd (Vdc)	Idd (mA)
+4.5	67.2
+5.0	67.4
+5.5	67.6

**Recommended Bias Resistor Values
for Various Idd1 & Idd2**

Idd1 + Idd2 (mA)	Rbias (Ohms)
60	27
70	16
80	13
100	8.2
120	3.9

**ELECTROSTATIC SENSITIVE DEVICE
OBSERVE HANDLING PRECAUTIONS**

Outline Drawing

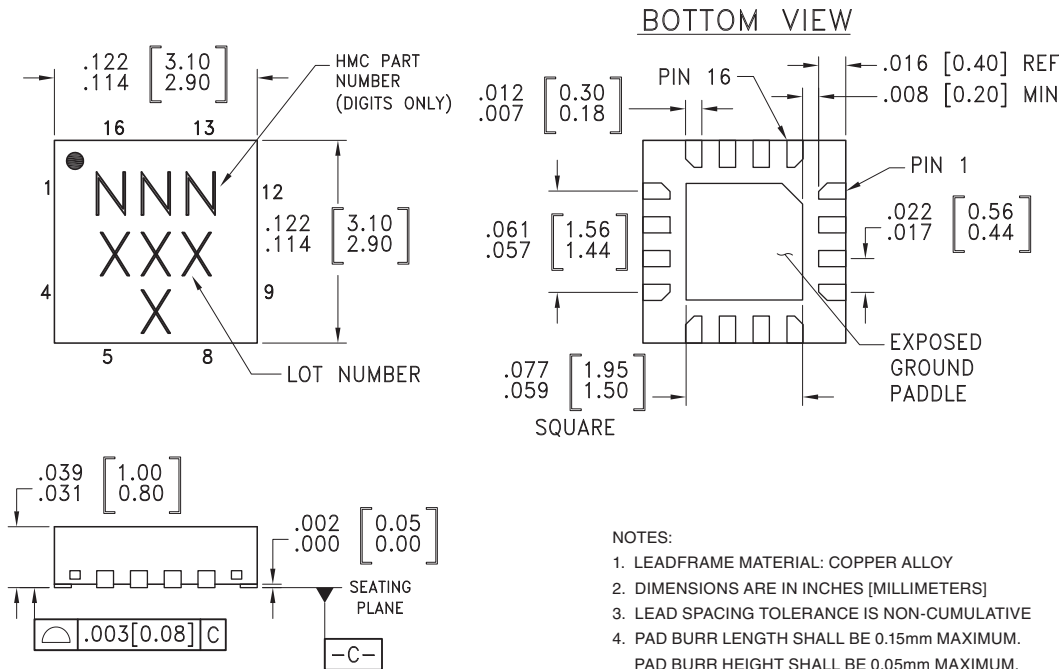

- NOTES:
1. LEADFRAME MATERIAL: COPPER ALLOY
 2. DIMENSIONS ARE IN INCHES [MILLIMETERS]
 3. LEAD SPACING TOLERANCE IS NON-CUMULATIVE
 4. PAD BURR LENGTH SHALL BE 0.15mm MAXIMUM.
PAD BURR HEIGHT SHALL BE 0.05mm MAXIMUM.
 5. PACKAGE WARP SHALL NOT EXCEED 0.05mm.
 6. ALL GROUND LEADS AND GROUND PADDLE MUST BE SOLDERED TO PCB RF GROUND.
 7. REFER TO HITTITE APPLICATION NOTE FOR SUGGESTED LAND PATTERN.

Package Information

Part Number	Package Body Material	Lead Finish	MSL Rating	Package Marking ^[3]
HMC382LP3	Low Stress Injection Molded Plastic	Sn/Pb Solder	MSL1 ^[1]	382 XXXX
HMC382LP3E	RoHS-compliant Low Stress Injection Molded Plastic	100% matte Sn	MSL1 ^[2]	382 XXXX

[1] Max peak reflow temperature of 235 °C

[2] Max peak reflow temperature of 260 °C

[3] 4-Digit lot number XXXX



Pin Descriptions

Pin Number	Function	Description	Interface Schematic
1, 4, 5, 7, 9, 12, 14, 16	N/C	No connection necessary. These pins may be connected to RF/DC ground. Performance will not be affected.	
2	RFIN	This pin is AC coupled and matched to 50 Ohms.	RFIN ○ — —
3, 6, 10	GND	These pins and package bottom must be connected to RF/DC ground.	○ GND ⏏
8	Res	This pin is used to set the DC current of the amplifier by selection of external bias resistor. See application circuit.	 Res ○
11	RFOUT	This pin is AC coupled and matched to 50 Ohms.	— — ○ RFOUT
13,15	Vdd2, Vdd1	Power supply voltage. Choke inductor and bypass capacitors are required. See application circuit.	 ○ Vdd2, Vdd1

Application Circuit

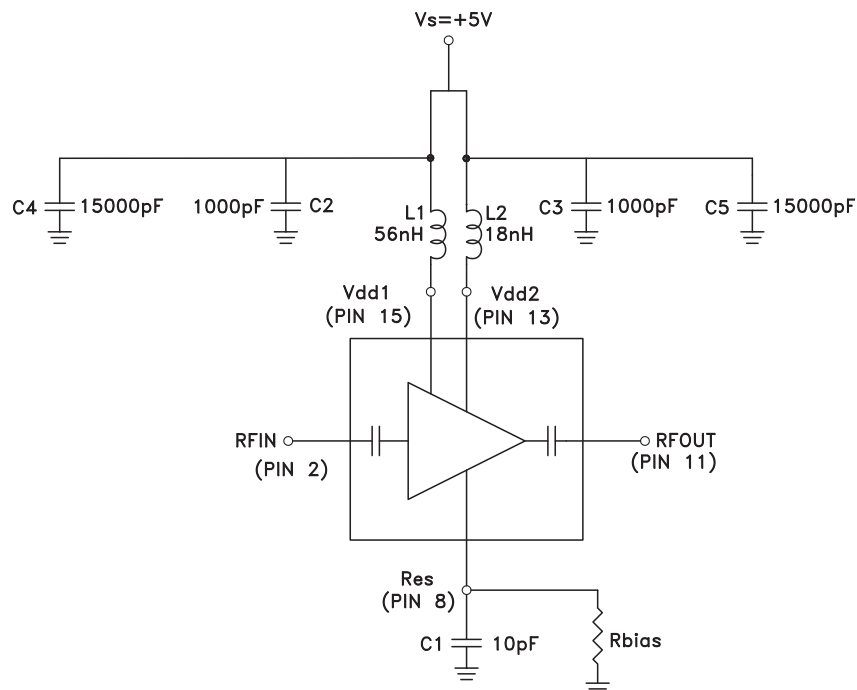

Note: L1, L2 and C1 should be located as close to pins as possible.

Evaluation PCB

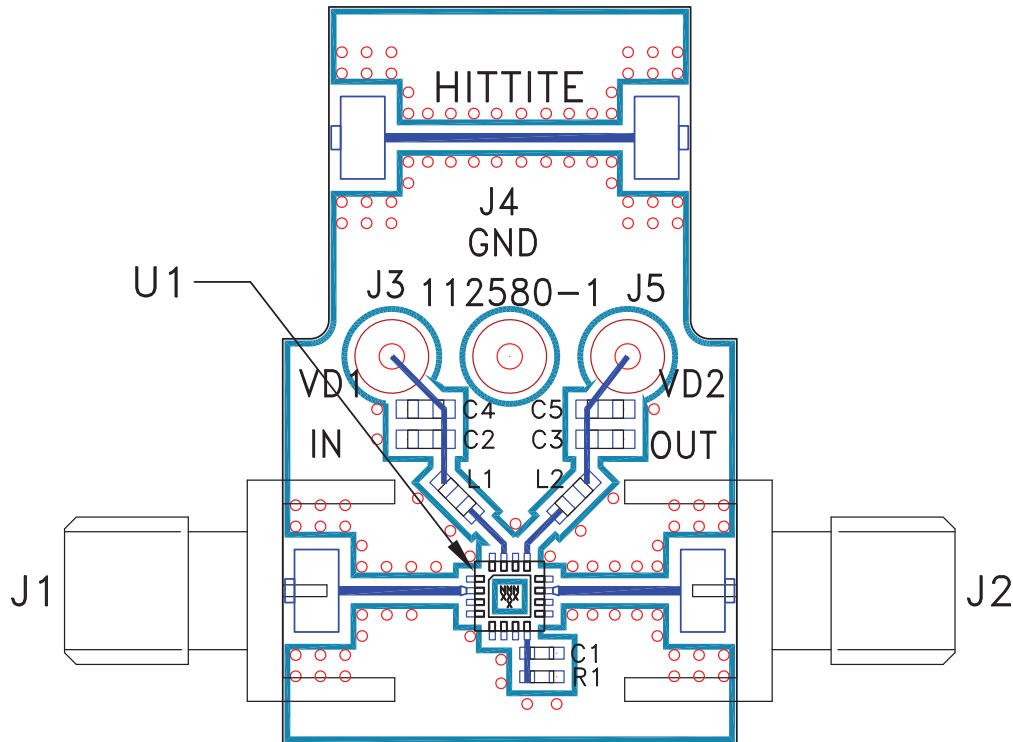

List of Materials for Evaluation PCB 112582 [1]

Item	Description
J1 - J2	PCB Mount SMA RF Connector
J3 - J5	DC Pin
C1	10 pF Capacitor, 0402 Pkg.
C2, C3	1000 pF Capacitor, 0603 Pkg.
C4, C5	15000 pF Capacitor, 0603 Pkg.
L1	56nH Inductor, 0603 Pkg.
L2	18nH Inductor, 0603 Pkg.
R1	Resistor, 0402 Pkg.
U1	HMC382LP3 / HMC382LP3E Amplifier
PCB [2]	112580 Evaluation PCB

[1] Reference this number when ordering complete evaluation PCB

[2] Circuit Board Material: Rogers 4350

The circuit board used in the application should use RF circuit design techniques. Signal lines should have 50 Ohm impedance while the package ground leads and exposed ground paddle should be connected directly to the ground plane similar to that shown. A sufficient number of via holes should be used to connect the top and bottom ground planes. The evaluation circuit board shown is available from Hittite upon request.