



## GaAs PHEMT MMIC MEDIUM POWER AMPLIFIER, 17.5 - 24.0 GHz

### Typical Applications

The HMC442LM1 is an ideal gain block or driver amplifier for:

- Point-to-Point Radios
- Point-to-Multi-Point Radios
- VSAT

### Features

- Saturated Power: +23 dBm @ 27% PAE
- Gain: 14 dB
- Supply Voltage: +5V
- 50 Ohm Matched Input/Output

### Functional Diagram

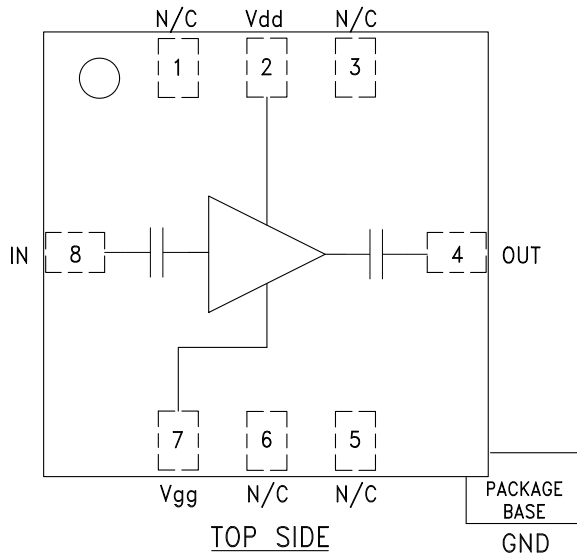

### General Description

The HMC442LM1 is a broadband 17.5 to 24 GHz GaAs PHEMT MMIC Medium Power Amplifier in a SMT leadless chip carrier package. The LM1 is a true surface mount broadband millimeterwave package offering low loss & excellent I/O match, preserving MMIC chip performance. The amplifier provides 14 dB of gain and +23 dBm of saturated power at 27% PAE from a +5V supply voltage. This 50 Ohm matched amplifier has integrated DC blocks on RF in and out and makes an ideal linear gain block, transmit chain driver or LO driver for HMC SMT mixers. As an alternative to chip-and-wire hybrid assemblies the HMC442LM1 eliminates the need for wirebonding, thereby providing a consistent connection interface for the customer.

### Electrical Specifications, $T_A = +25^\circ C$ , $V_{dd} = 5V$ , $I_{dd} = 85 mA^*$

Parameter	Min.	Typ.	Max.	Min.	Typ.	Max.	Units
Frequency Range	17.5 - 21.0		21.0 - 24.0		GHz		
Gain	10.5	13		10.5	14		dB
Gain Variation Over Temperature		0.02	0.03		0.02	0.03	dB/ °C
Input Return Loss		10			10		dB
Output Return Loss		7			8		dB
Output Power for 1 dB Compression (P1dB)	17	20		18.5	21.5		dBm
Saturated Output Power (P <sub>sat</sub> )		23			23.5		dBm
Output Third Order Intercept (IP3)		28			27		dBm
Noise Figure		7			6.5		dB
Supply Current (I <sub>dd</sub> )(V <sub>dd</sub> = 5V, V <sub>gg</sub> = -1V Typ.)		85			85		mA

\*Adjust V<sub>gg</sub> between -1.5 to -0.5V to achieve I<sub>dd</sub> = 85 mA typical.



**GaAs PHEMT MMIC MEDIUM  
POWER AMPLIFIER, 17.5 - 24.0 GHz**

**Broadband Gain & Return Loss**

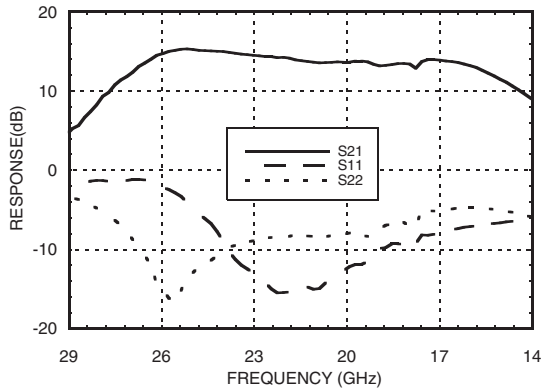

**Gain vs. Temperature**

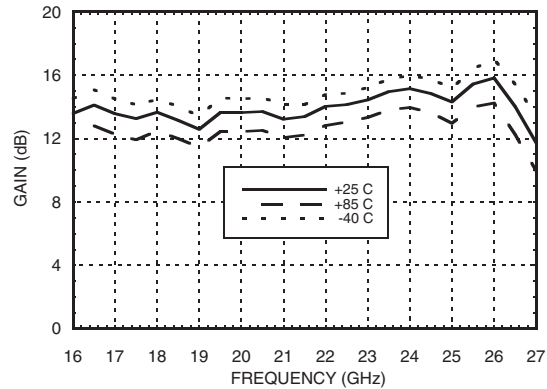

**Input Return Loss vs. Temperature**

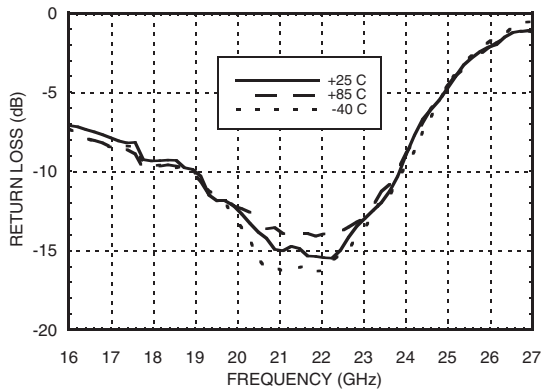

**Output Return Loss vs. Temperature**

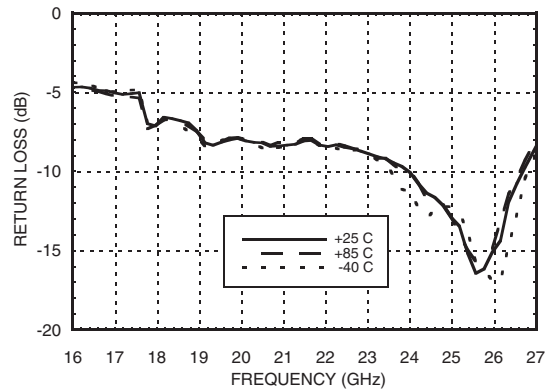

**P1dB vs. Temperature**

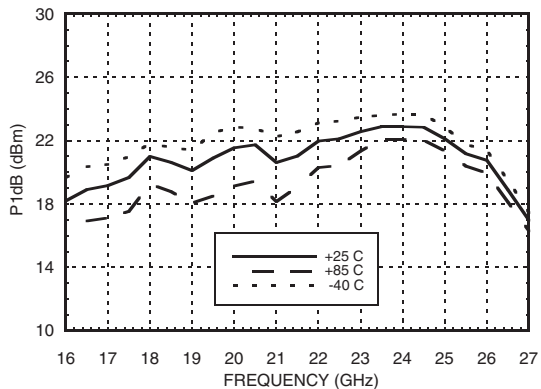

**Psat vs. Temperature**

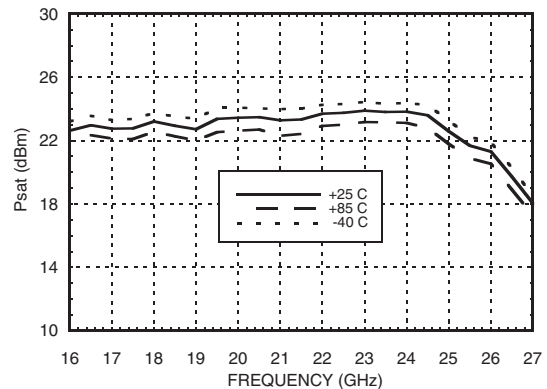

11

LINEAR & POWER AMPLIFIERS - SMT



**GaAs PHEMT MMIC MEDIUM  
POWER AMPLIFIER, 17.5 - 24.0 GHz**

**Power Compression @ 18 GHz**

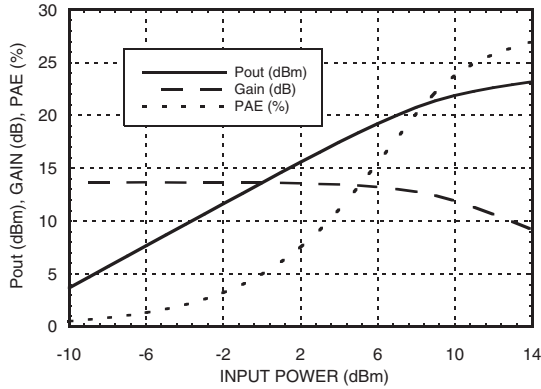

**Power Compression @ 23 GHz**

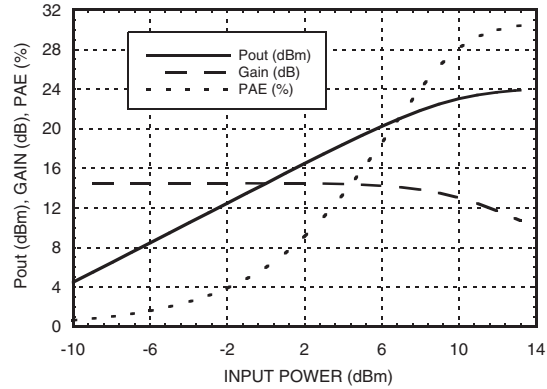

**Output IP3 vs. Temperature**

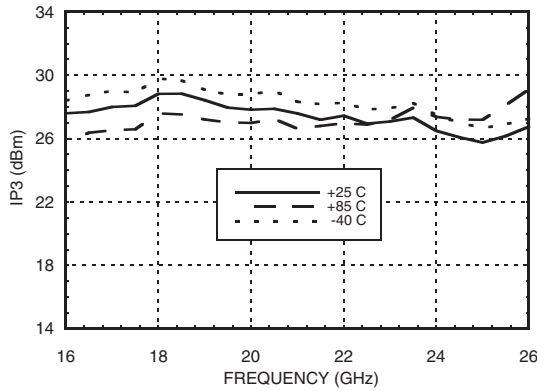

**Noise Figure vs. Temperature**

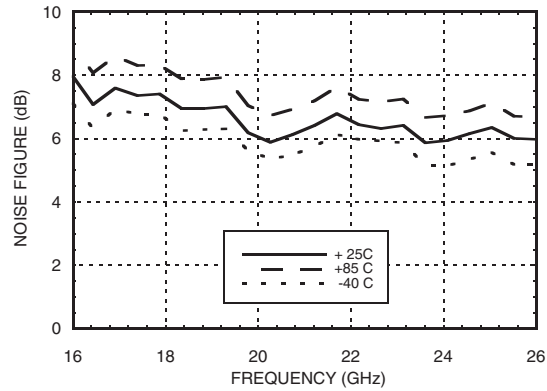

**Gain & Power vs.  
Supply Voltage @ 23 GHz**

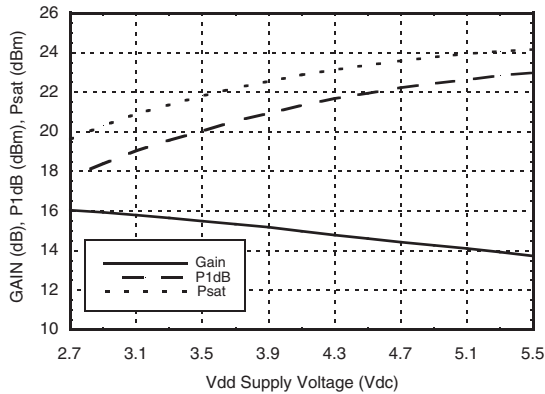

**Reverse Isolation vs. Temperature**

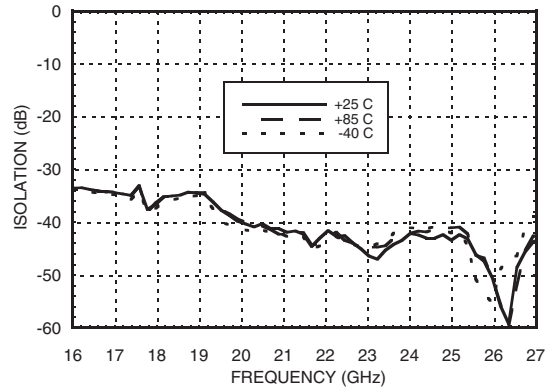



## GaAs PHEMT MMIC MEDIUM POWER AMPLIFIER, 17.5 - 24.0 GHz

### Absolute Maximum Ratings

Drain Bias Voltage (Vdd)	+5.5 Vdc
Gate Bias Voltage (Vgg)	-8.0 to 0 Vdc
RF Input Power (RFIN)(Vdd = +5Vdc, Idd = 85 mA)	+16 dBm
Channel Temperature	175 °C
Continuous Pdiss (T = 85 °C) (derate 5.46 mW/°C above 85 °C)	0.491 W
Thermal Resistance (channel to ground paddle)	183 °C/W
Storage Temperature	-65 to +150 °C
Operating Temperature	-40 to +85 °C

### Typical Supply Current vs. Vdd

Vdd (V)	Idd (mA)
+4.5	82
+5.0	85
+5.5	87
+2.7	79
+3.0	83
+3.3	86

Note: Amplifier will operate over full voltage range shown above



**ELECTROSTATIC SENSITIVE DEVICE  
OBSERVE HANDLING PRECAUTIONS**

### Outline Drawing

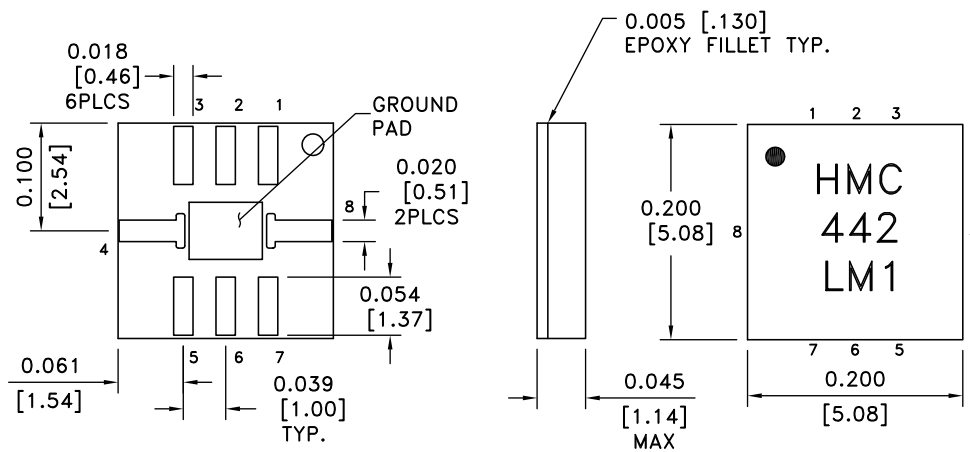

**NOTES:**

1. MATERIAL: PLASTIC
2. PLATING: GOLD OVER NICKEL
3. DIMENSIONS ARE IN INCHES [MILLIMETERS].
4. ALL TOLERANCES ARE  $\pm 0.005$  [ $\pm 0.13$ ].
5. ALL GROUNDS MUST BE SOLDERED TO PCB RF GROUND.
6. • INDICATES PIN 1.

**Pin Descriptions**

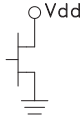
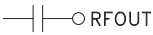
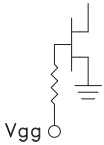
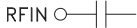
Pin Number	Function	Description	Interface Schematic
1, 3, 5, 6	N/C	No connection	
2	Vdd	Power Supply Voltage for the amplifier. External bypass capacitors of 100 pF and 0.01 $\mu$ F are required.	
4	RFOUT	This pin is AC coupled and matched to 50 Ohms.	
7	Vgg	Gate control for amplifier. Adjust to achieve Id of 85 mA. Please follow "MMIC Amplifier Biasing Procedure" Application Note.	
8	RFIN	This pin is AC coupled and matched to 50 Ohms.	

### Evaluation PCB

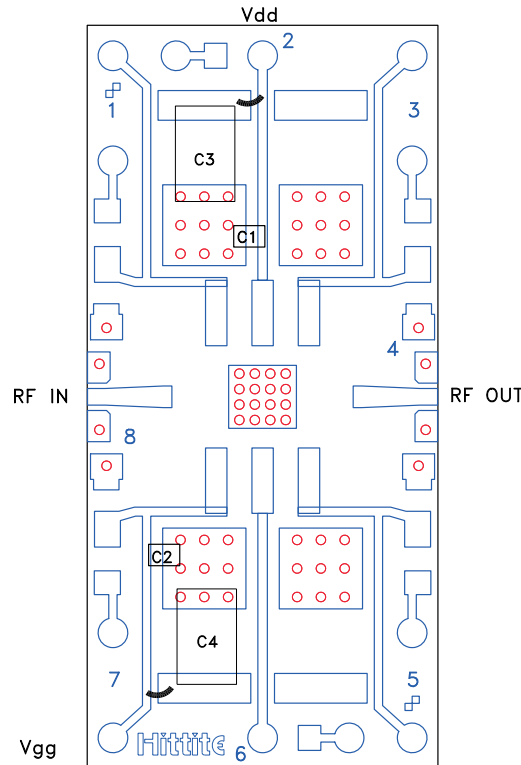

The grounded Co-Planar Wave Guide (CPWG) PCB input/output transitions allow use of Ground-Signal-Ground (GSG) probes for testing. Suggested probe pitch is 400um (16 mils). Alternatively, the board can be mounted in a metal housing with 2.4mm coaxial connectors.

### Evaluation Circuit Board Layout Design Details

Layout Technique	Micro Strip to CPWG
Material	Rogers 4003 with 1/2 oz, Cu
Dielectric Thickness	0.008" (0.20 mm)
Microstrip Line Width	0.018" (0.46 mm)
CPWG Line Width	0.016" (0.41 mm)
CPWG Line to GND Gap	0.005" (0.13 mm)
Ground VIA Hole Diameter	0.008" (0.20 mm)
C1 - C2	100 pF Capacitor, 0402 Pkg.
C3 - C4	33.000 pF Capacitor, 0805 Pkg.

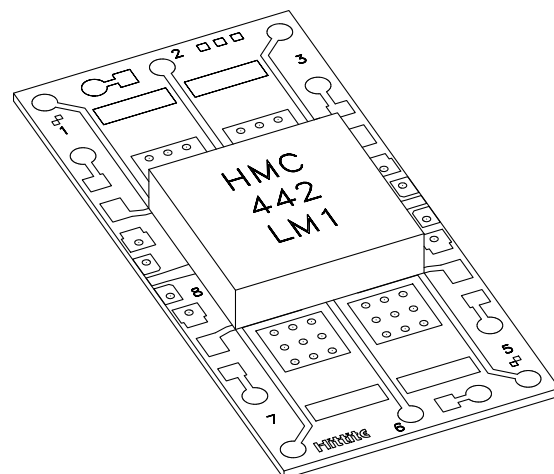

**Suggested LM1 PCB Land Pattern** Tolerance:  $\pm 0.003''$  ( $\pm 0.08$  mm)

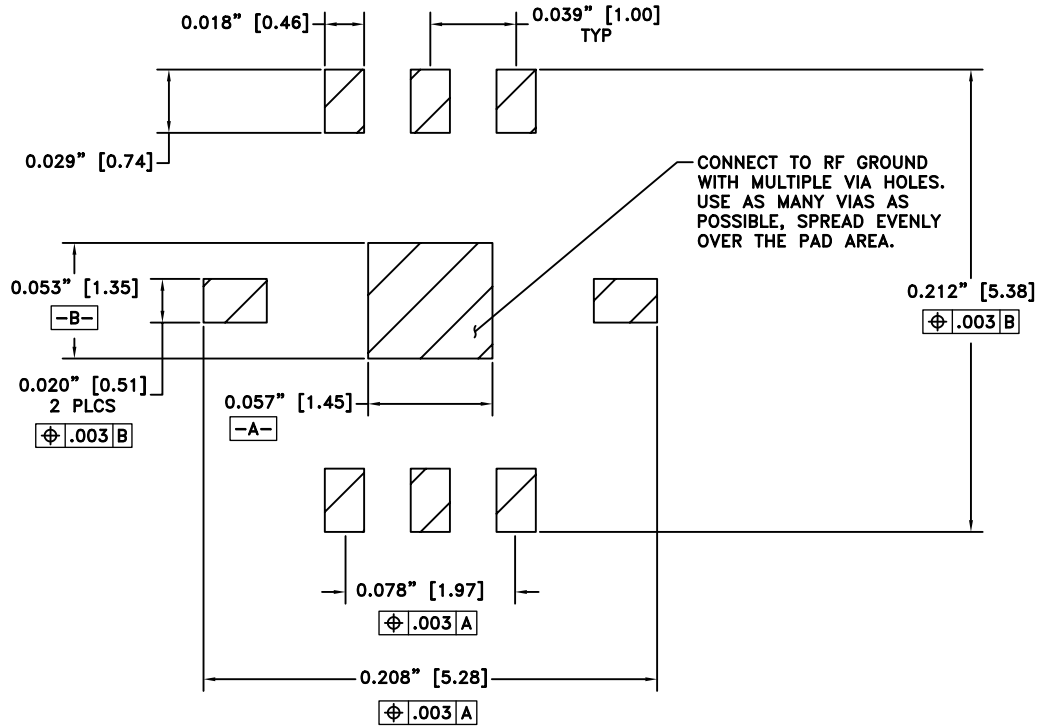

### Amplifier Application Circuit

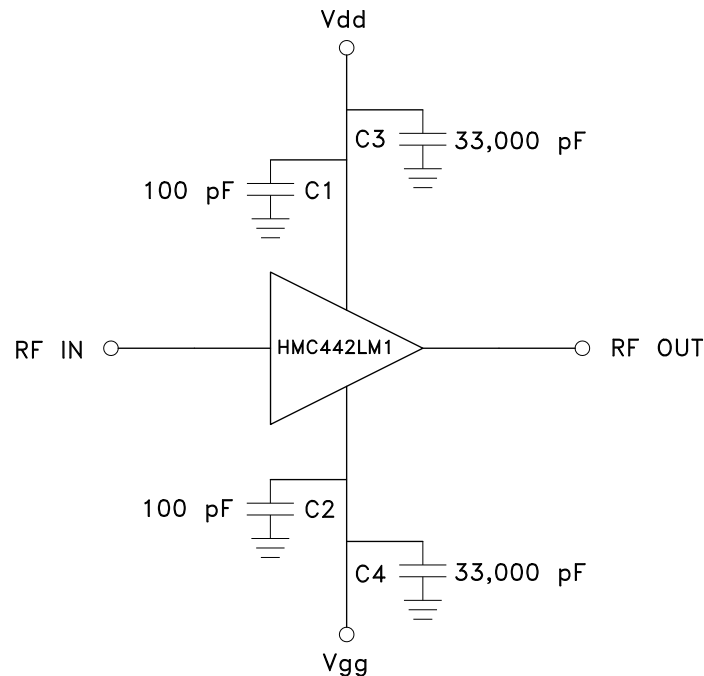



## Recommended SMT Attachment Technique

### Preparation & Handling of the LM1 Microwave Package for Surface Mounting

The HMC LM1 package was designed to be compatible with high volume surface mount PCB assembly processes. The LM1 package requires a specific mounting pattern to allow proper mechanical attachment and to optimize electrical performance at millimeterwave frequencies. This PCB layout pattern can be found on each LM1 product data sheet. It can also be provided as an electronic drawing upon request from Hittite Sales & Application Engineering.

#### Follow these precautions to avoid permanent damage:

**Cleanliness:** Observe proper handling procedures to ensure clean devices and PCBs. LM1 devices should remain in their original packaging until component placement to ensure no contamination or damage to RF, DC & ground contact areas.

**Static Sensitivity:** Follow ESD precautions to protect against ESD strikes.

**General Handling:** Handle the LM1 package on the top with a vacuum collet or along the edges with a sharp pair of bent tweezers. Avoiding damaging the RF, DC, & ground contacts on the package bottom. Do not apply excess pressure to the top of the lid.

**Solder Materials & Temperature Profile:** Follow the information contained in the application note. Hand soldering is not recommended. Conductive epoxy attachment is not recommended.

**Solder Paste:** Solder paste should be selected based on the user's experience and be compatible with the metallization systems used. See the LM1 data sheet Outline drawing for pin & ground contact metallization schemes.

**Solder Paste Application:** Solder paste is generally applied to the PCB using either a stencil printer or dot placement. The volume of solder paste will be dependent on PCB and component layout and should be controlled to ensure consistent mechanical & electrical performance. Excess solder may create unwanted electrical parasitics at high frequencies.

**Solder Reflow:** The soldering process is usually accomplished in a reflow oven but may also use a vapor phase process. A solder reflow profile is suggested above.

Prior to reflowing product, temperature profiles should be measured using the same mass as the actual assemblies. The thermocouple should be moved to various positions on the board to account for edge and corner effects and varying component masses. The final profile should be determined by mounting the thermocouple to the PCB at the location of the device.

Follow solder paste and oven vendor's recommendations when developing a solder reflow profile. A standard profile will have a steady ramp up from room temperature to the pre-heat temperature to avoid damage due to thermal shock. Allow enough time between reaching pre-heat temperature and reflow for the solvent in the paste to evaporate and the flux to completely activate. Reflow must then occur prior to the flux being completely driven off. The duration of peak reflow temperature should not exceed 15 seconds. Packages have been qualified to withstand a peak temperature of 235°C for 15 seconds. Verify that the profile will not expose device to temperatures in excess of 235°C.

**Cleaning:** A water-based flux wash may be used.

