



Typical Applications

The HMC463LP5(E) is ideal for:

- Telecom Infrastructure
- Microwave Radio & VSAT
- Military EW, ECM & C³I
- Test Instrumentation
- Fiber Optics

Features

- Gain: 13 dB
- Noise Figure: 2.8 dB @ 10 GHz
- P1dB Output Power: +18 dBm @ 10 GHz
- Supply Voltage: +5V @ 60 mA
- 50 Ohm Matched Input/Output
- 32 Lead 5 x 5 mm SMT Package: 25 mm²

Functional Diagram

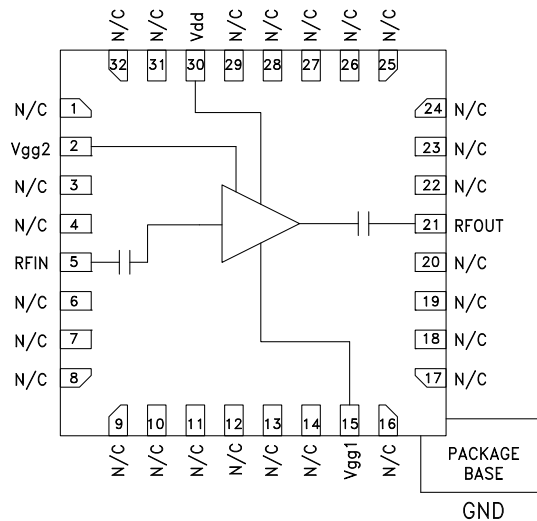

General Description

The HMC463LP5(E) is a GaAs MMIC pHEMT Low Noise AGC Distributed Amplifier packaged in a leadless 5x5 mm surface mount package which operates between 2 and 20 GHz. The amplifier provides 13 dB of gain, 2.8 dB noise figure and 18 dBm of output power at 1 dB gain compression while requiring only 60 mA from a +5V supply. An optional gate bias (Vgg2) is provided to allow Adjustable Gain Control (AGC) of 8 dB typical. Gain flatness is excellent at ±0.5 dB from 6 - 18 GHz making the HMC463LP5(E) ideal for EW, ECM RADAR and test equipment applications. The HMC463LP5(E) LNA I/Os are internally matched to 50 Ohms and are internally DC blocked.

Electrical Specifications, $T_A = +25^\circ\text{C}$, $V_{dd} = 5\text{V}$, $I_{dd} = 60\text{ mA}^*$

Parameter	Min.	Typ.	Max.	Min.	Typ.	Max.	Min.	Typ.	Max.	Units
Frequency Range	2 - 6			6 - 18			18 - 20			GHz
Gain	10	13		9	12		8	11		dB
Gain Flatness		±0.5			±0.5			±0.5		dB
Gain Variation Over Temperature		0.010	0.015		0.010	0.015		0.010	0.015	dB/ °C
Noise Figure		3	4		3	5		5.5	6.5	dB
Input Return Loss		15			13			12		dB
Output Return Loss		13			10			10		dB
Output Power for 1 dB Compression (P1dB)	16	19		11	16		10	12		dBm
Saturated Output Power (Psat)		21			19			19		dBm
Output Third Order Intercept (IP3)		30			24			22		dBm
Supply Current (Idd) (Vdd = 5V, Vgg1 = -0.9V Typ.)		60	80		60	80		60	80	mA

* Adjust Vgg1 between -2 to -0V to achieve Idd = 60 mA typical.



Gain & Return Loss

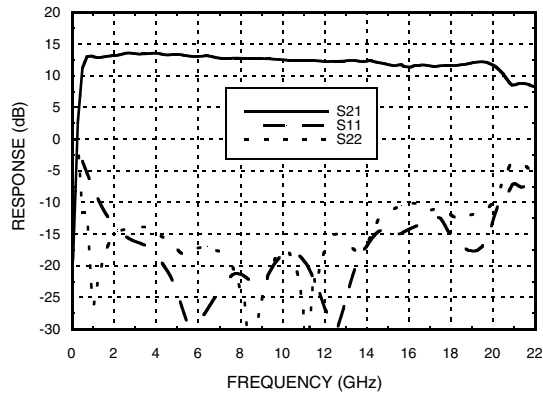

Gain vs. Temperature

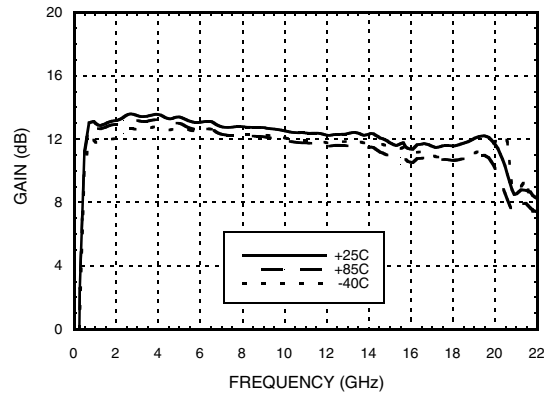

Input Return Loss vs. Temperature

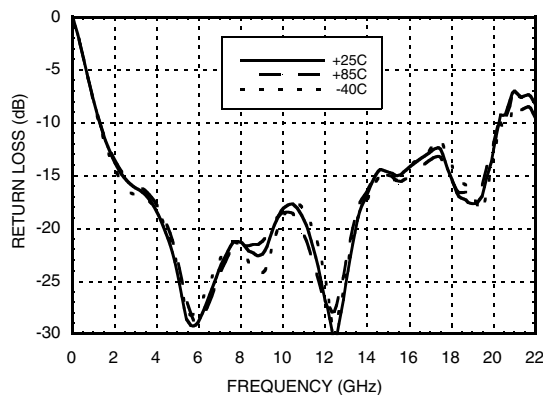

Output Return Loss vs. Temperature

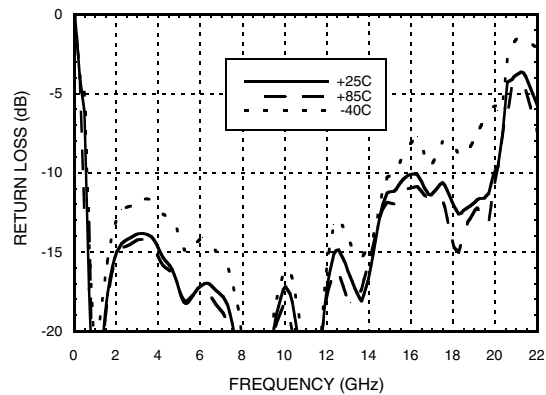

Reverse Isolation vs. Temperature

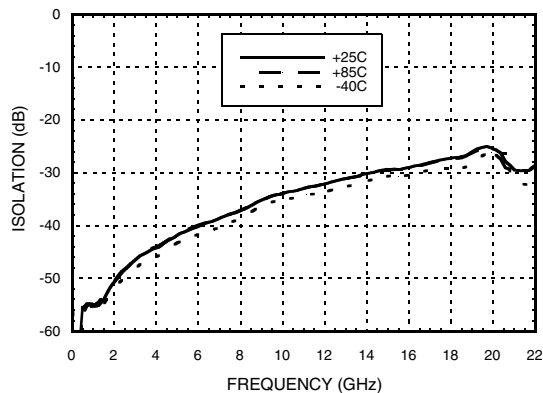

Noise Figure vs. Temperature

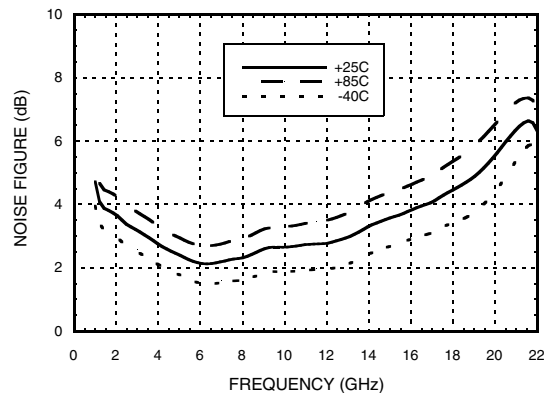



HMC463LP5 / 463LP5E

GaAs pHEMT MMIC LOW NOISE AGC AMPLIFIER, 2 - 20 GHz

P1dB vs. Temperature

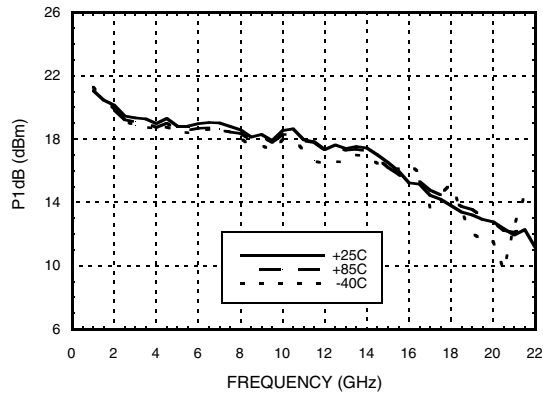

Psat vs. Temperature

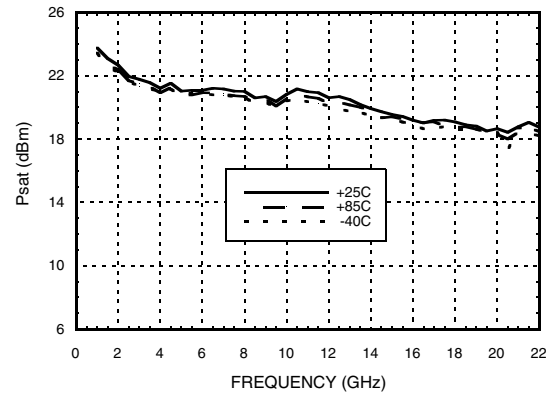

Output IP3 vs. Temperature

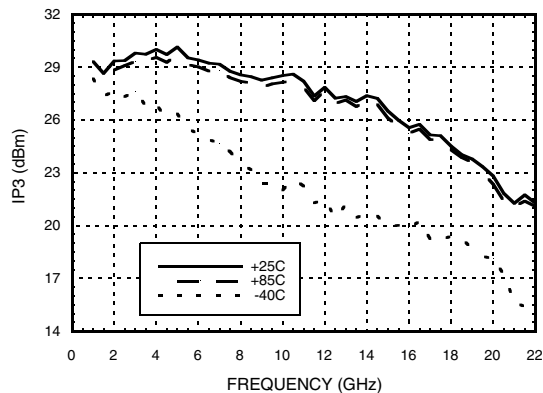

Gain, Power & Noise Figure vs. Supply Voltage @ 10 GHz, Fixed Vgg1

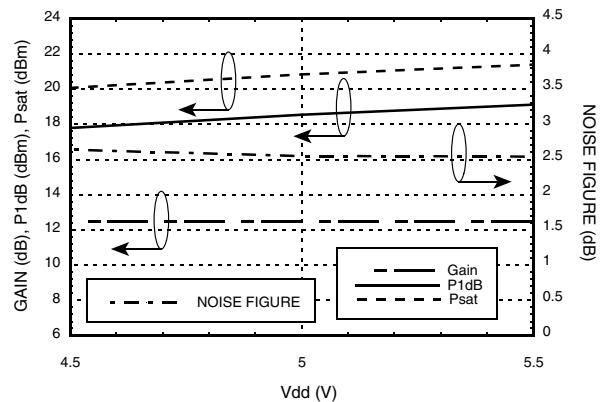

Gain, P1dB & Output IP3 vs. Control Voltage @ 10 GHz

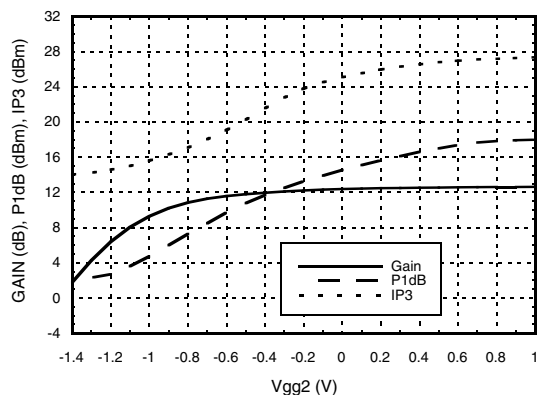

Noise Figure & Supply Current vs. Control Voltage @ 10 GHz

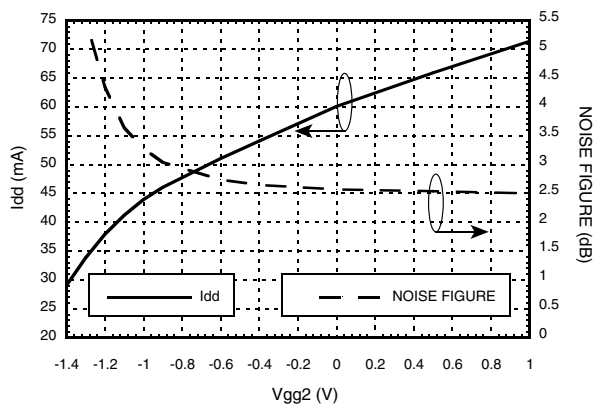



HMC463LP5 / 463LP5E

GaAs pHEMT MMIC LOW NOISE AGC AMPLIFIER, 2 - 20 GHz

7

Gain @ Several Control Voltages (V_{gg2})

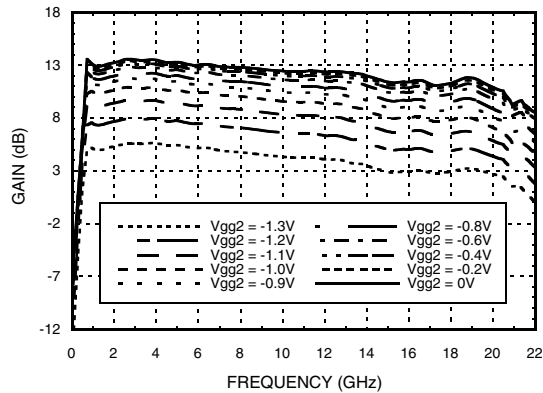

**ELECTROSTATIC SENSITIVE DEVICE
OBSERVE HANDLING PRECAUTIONS**

Absolute Maximum Ratings

Drain Bias Voltage (V _{dd})	+9V
Gate Bias Voltage (V _{gg1})	-2 to 0V
Gate Bias Current (I _{gg1})	2.5 mA
Gate Bias Voltage (V _{gg2})(AGC)	(V _{dd} -9) V _{dc} to +2V
RF Input Power (RFIN)(V _{dd} = +5V)	+18 dBm
Channel Temperature	150 °C
Continuous P _{diss} (T= 85 °C) (derate 19.1 mW/°C above 85 °C)	1.24 W
Thermal Resistance (channel to ground paddle)	52.3 °C/W
Storage Temperature	-65 to +150 °C
Operating Temperature	-40 to +85 °C

Typical Supply Current vs. V_{dd}

V _{dd} (V)	I _{dd} (mA)
+4.5	58
+5.0	60
+5.5	62

AMPLIFIERS - LOW NOISE - SMT

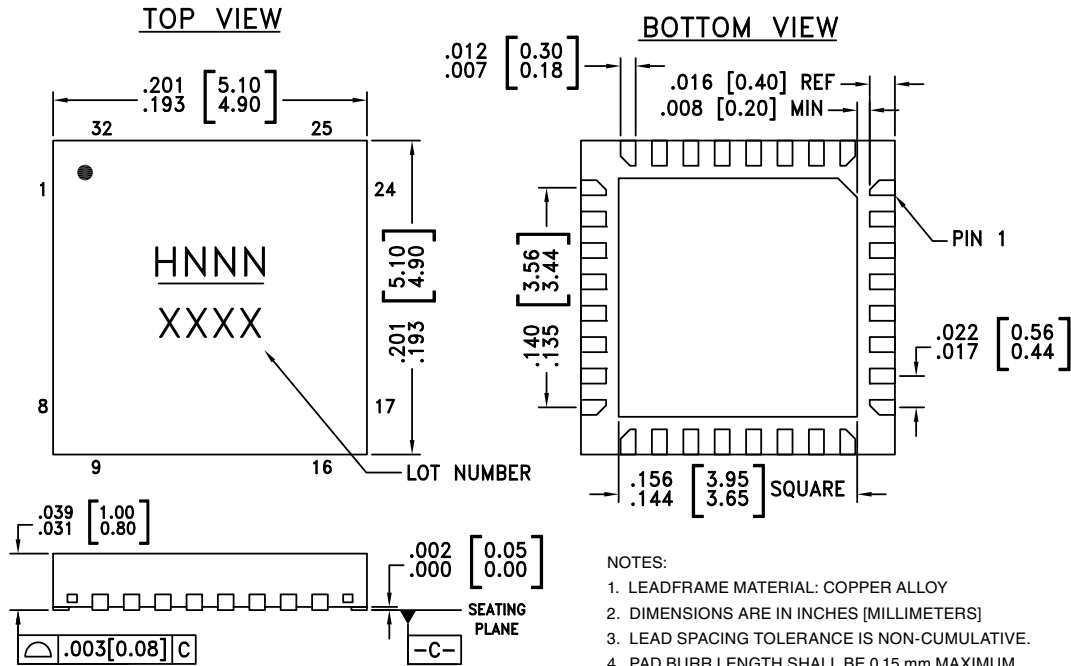
Outline Drawing

NOTES:

1. LEADFRAME MATERIAL: COPPER ALLOY
2. DIMENSIONS ARE IN INCHES [MILLIMETERS]
3. LEAD SPACING TOLERANCE IS NON-CUMULATIVE.
4. PAD BURR LENGTH SHALL BE 0.15 mm MAXIMUM.
PAD BURR HEIGHT SHALL BE 0.05 mm MAXIMUM.
5. PACKAGE WARP SHALL NOT EXCEED 0.05 mm.
6. ALL GROUND LEADS AND GROUND PADDLE MUST BE SOLDERED TO PCB RF GROUND.
7. REFER TO HITTITE APPLICATION NOTE FOR SUGGESTED LAND PATTERN.

Package Information



Part Number	Package Body Material	Lead Finish	MSL Rating	Package Marking ^[3]
HMC463LP5	Low Stress Injection Molded Plastic	Sn/Pb Solder	MSL1 ^[1]	H463 XXXX
HMC463LP5E	RoHS-compliant Low Stress Injection Molded Plastic	100% matte Sn	MSL1 ^[2]	H463 XXXX

[1] Max peak reflow temperature of 235 °C

[2] Max peak reflow temperature of 260 °C

[3] 4-Digit lot number XXXX

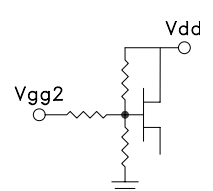
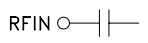
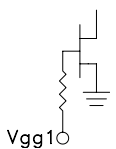
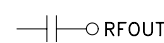
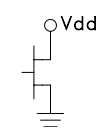
Pin Descriptions

Pin Number	Function	Description	Interface Schematic
1, 3, 4, 6-14, 16-20, 22-29, 31, 32	N/C	The pins are not connected internally; however, all data shown herein was measured with these pins connected to RF/DC ground externally.	
2	Vgg2	Optional gate control if AGC is required. Leave Vgg2 open circuited if AGC is not required. Typical Vgg2 = -1.5V to 0V	
5	RFIN	This pad is AC coupled and matched to 50 Ohms	
15	Vgg1	Gate control for amplifier. Adjust to achieve I _{dd} = 60 mA.	
21	RFOUT	This pad is AC coupled and matched to 50 Ohms	
30	Vdd	Power supply voltage for the amplifier. External bypass capacitors are required	
Ground Paddle	GND	Ground paddle must be connected to RF/DC ground.	

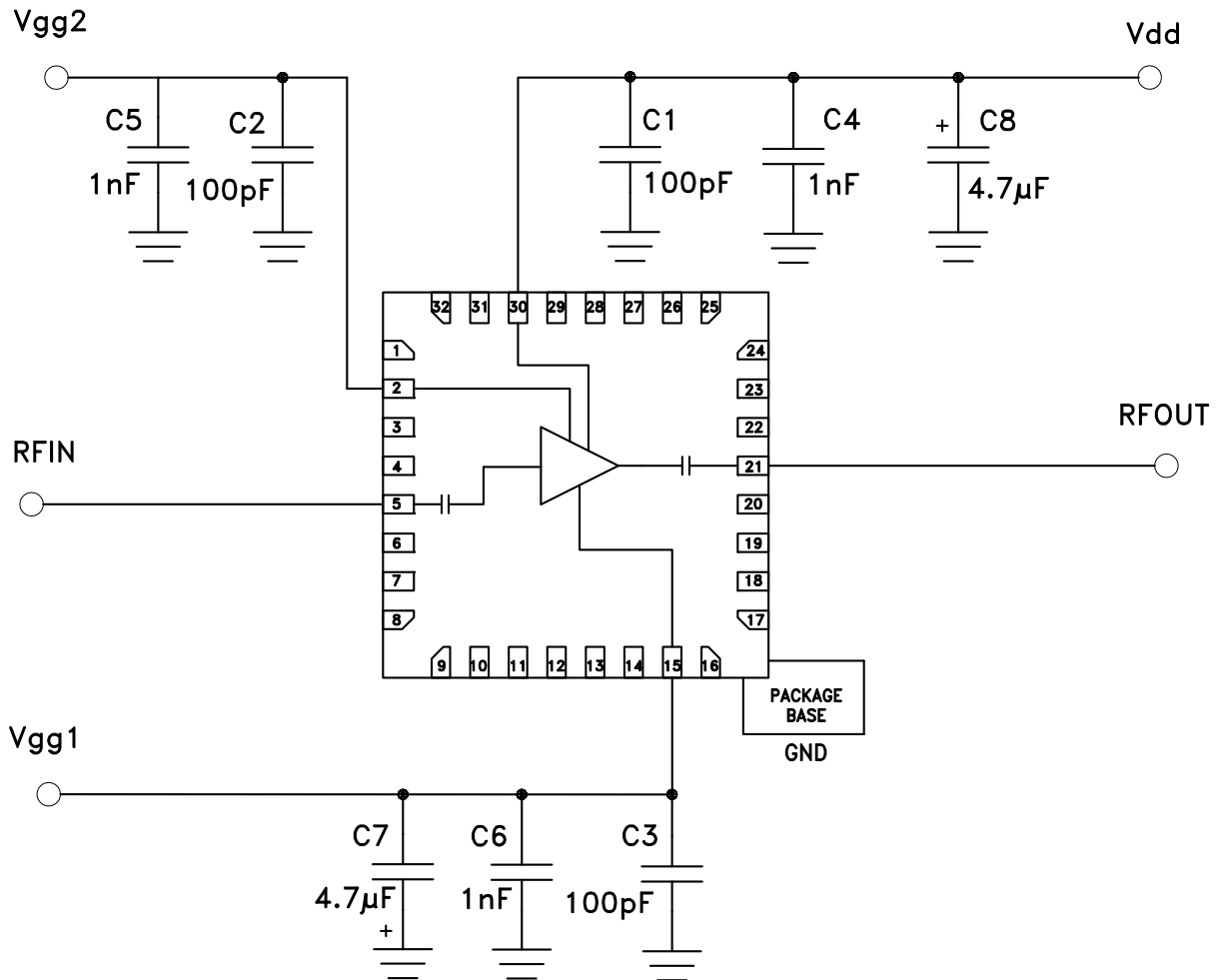
Application Circuit

Evaluation PCB

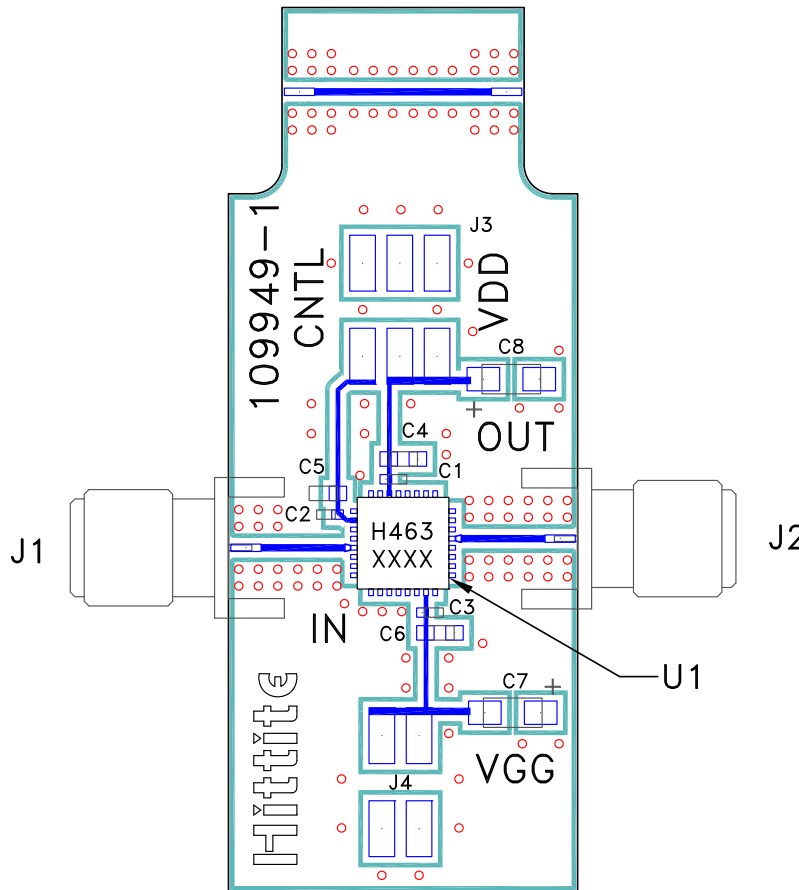

List of Materials for Evaluation PCB 108341 [1]

Item	Description
J1 - J2	SRI K Connector
J3 - J4	2 mm Molex Header
C1 - C3	100 pF Capacitor, 0402 Pkg.
C4 - C6	1000 pF Capacitor, 0603 Pkg.
C7 - C8	4.7 μ F Capacitor, Tantalum
U1	HMC463LP5(E) Amplifier
PCB [2]	109949 Evaluation PCB

[1] Reference this number when ordering complete evaluation PCB

[2] Circuit Board Material: Rogers 4350 or Arlon 25FR

The circuit board used in the application should use RF circuit design techniques. Signal lines should have 50 Ohm impedance while the package ground leads and package bottom should be connected directly to the ground plane similar to that shown. A sufficient number of via holes should be used to connect the top and bottom ground planes. The evaluation board should be mounted to an appropriate heat sink. The evaluation circuit board shown is available from Hittite upon request.