



SiGe HBT GAIN BLOCK MMIC AMPLIFIER, DC - 6 GHz

Typical Applications

The HMC476SC70(E) is ideal for:

- Cellular / PCS / 3G
- WiBro / WiMAX / 4G
- Fixed Wireless & WLAN
- CATV, Cable Modem & DBS
- Microwave Radio & Test Equipment

Features

- P1dB Output Power: +12 dBm
- Gain: 20 dB
- Output IP3: +24 dBm
- Cascadable 50 Ohm I/Os
- Single Supply: +5V to +12V
- Industry Standard SC70 Package

Functional Diagram

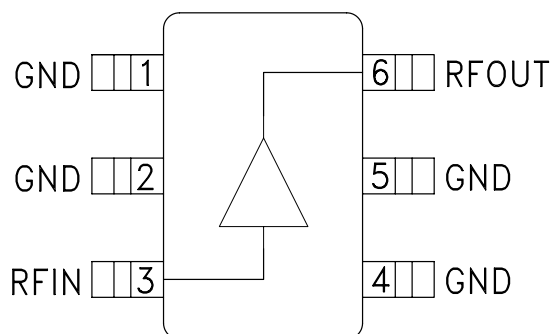

General Description

The HMC476SC70(E) is a SiGe Heterojunction Bipolar Transistor (HBT) Gain Block MMIC SMT amplifiers covering DC to 6 GHz. This industry standard SC70 packaged amplifier can be used as a cascadable 50 Ohm RF/IF gain stage as well as a LO or PA driver with up to +12 dBm output power. The HMC476SC70(E) offers 20 dB of gain with a +24 dBm output IP3 at 850 MHz while requiring only 35 mA from a single positive supply. The Darlington topology results in reduced sensitivity to normal process variations and excellent gain stability over temperature while requiring a minimal number of external bias components.

Electrical Specifications, $V_s = 5V$, $R_{bias} = 56 \text{ Ohm}$, $T_A = +25^\circ \text{ C}$

Parameter		Min.	Typ.	Max.	Units
Gain	DC - 2.0 GHz	16	19		dB
	2.0 - 4.0 GHz	13	16		dB
	4.0 - 6.0 GHz	9	12		dB
Gain Variation Over Temperature	DC - 6 GHz		0.008	0.012	dB/ °C
Input Return Loss	DC - 4 GHz		20		dB
	4.0 - 6.0 GHz		15		dB
Output Return Loss	DC - 4 GHz		20		dB
	4.0 - 6.0 GHz		13		dB
Reverse Isolation	DC - 6 GHz		18		dB
Output Power for 1 dB Compression (P1dB)	0.5 - 4.0 GHz	9.0	12.0		dBm
	4.0 - 6.0 GHz	8.0	11.0		dBm
Output Third Order Intercept (IP3) (Pout= 0 dBm per tone, 1 MHz spacing)	0.5 - 4.0 GHz		24		dBm
	4.0 - 6.0 GHz		22		dBm
Noise Figure	0.5 - 4.0 GHz		2.5		dB
	4.0 - 6.0 GHz		3.0		dB
Supply Current (Icq)			35	42	mA

For price, delivery and to place orders: Hittite Microwave Corporation, 20 Alpha Road, Chelmsford, MA 01824

Phone: 978-250-3343 Fax: 978-250-3373 Order On-line at www.hittite.com

Application Support: Phone: 978-250-3343 or apps@hittite.com

Broadband Gain & Return Loss

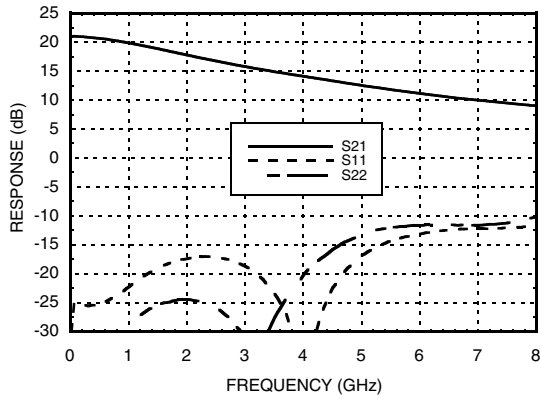

Gain vs. Temperature

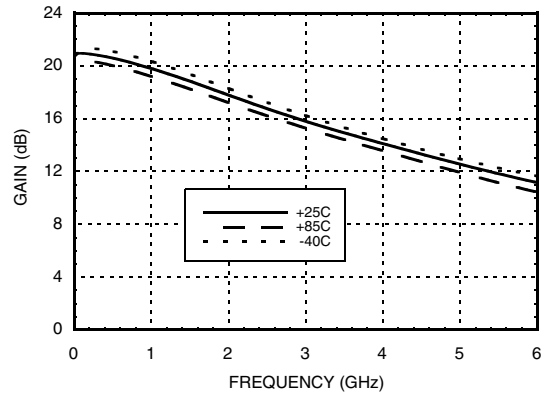

Input Return Loss vs. Temperature

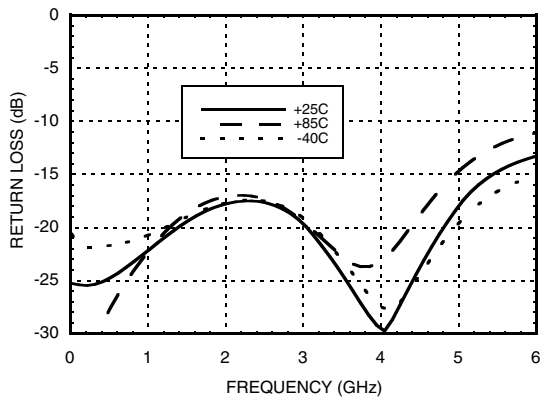

Output Return Loss vs. Temperature

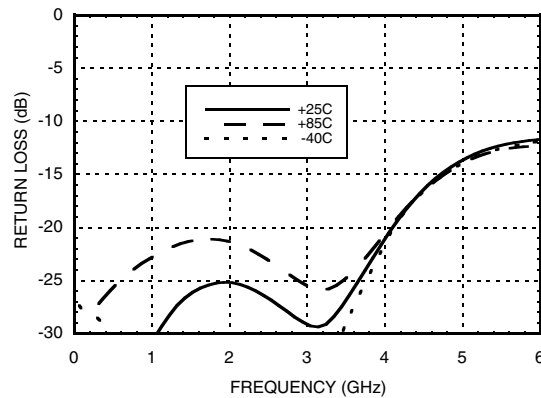

Reverse Isolation vs. Temperature

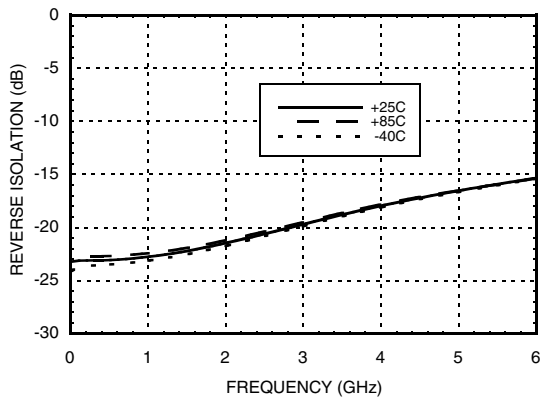

Noise Figure vs. Temperature

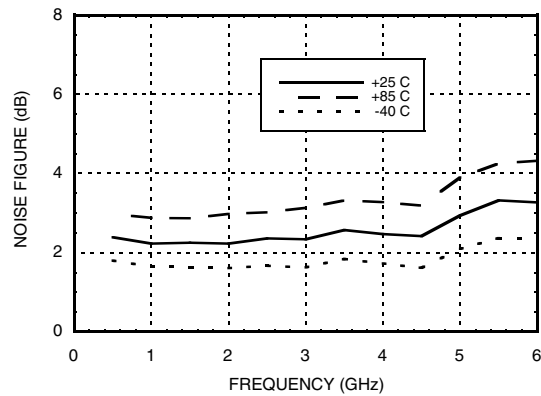



HMC476SC70 / 476SC70E

SiGe HBT GAIN BLOCK MMIC AMPLIFIER, DC - 6 GHz

P1dB vs. Temperature

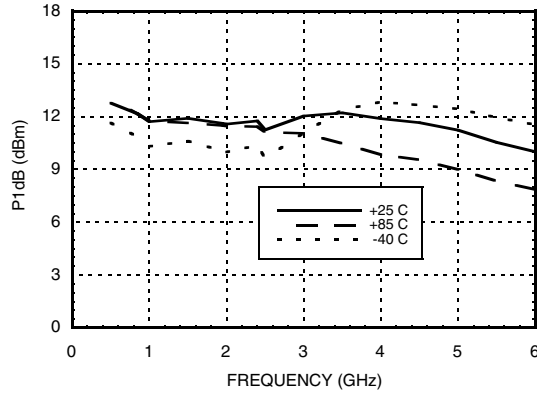

Psat vs. Temperature

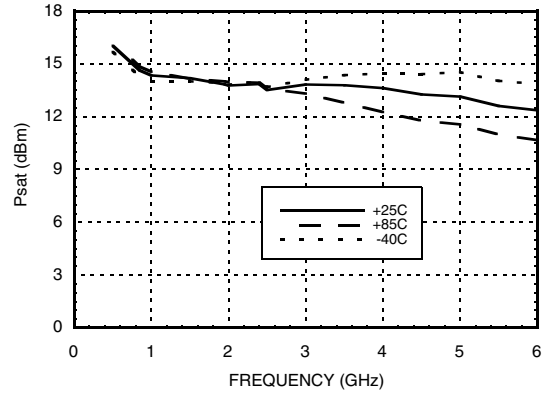

Output IP3 vs. Temperature

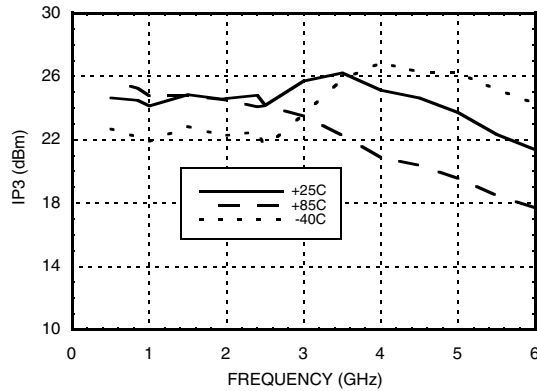

Gain, Power & OIP3 vs. Supply Voltage for Constant Icc = 35 mA @ 850 MHz

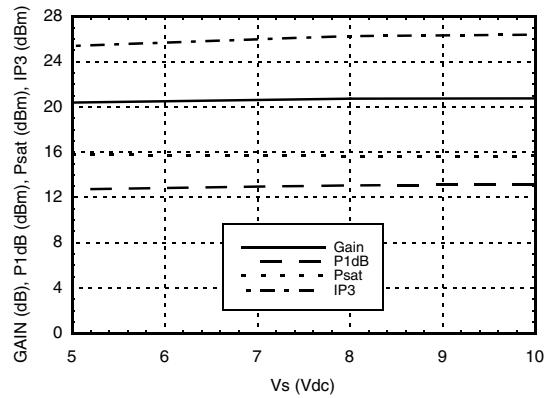

Icc vs. Vcc Over Temperature for Fixed Vs = 5V, RBIAS = 56 Ohms

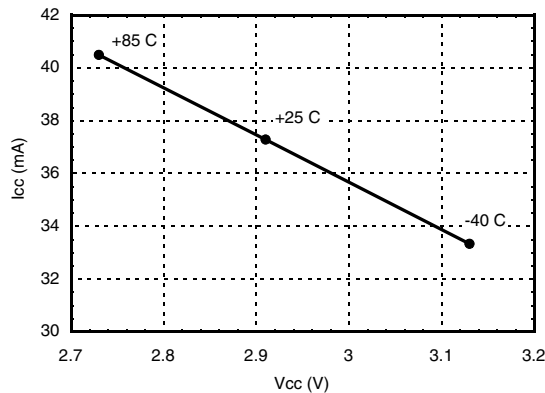

Absolute Maximum Ratings

Collector Bias Voltage (Vcc)	+6V
Collector Bias Current (Icc)	45 mA
RF Input Power (RFIN)(Vcc = +2.4V)	+5 dBm
Junction Temperature	150 °C
Continuous P _{diss} (T = 85 °C) (derate 7.75 mW/°C above 85 °C)	0.504 W
Thermal Resistance (junction to lead)	129 °C/W
Storage Temperature	-65 to +150 °C
Operating Temperature	-40 to +85 °C

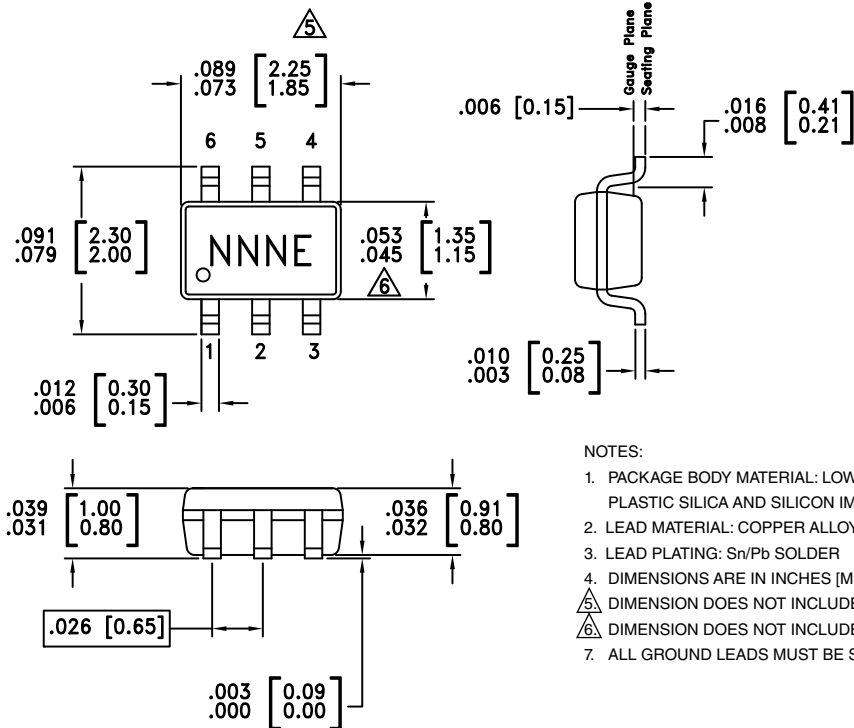
**ELECTROSTATIC SENSITIVE DEVICE
OBSERVE HANDLING PRECAUTIONS**
8
AMPLIFIERS - DRIVER & GAIN BLOCK - SMT
Outline Drawing

NOTES:

1. PACKAGE BODY MATERIAL: LOW STRESS INJECTION MOLDED PLASTIC SILICA AND SILICON IMPREGNATED.
2. LEAD MATERIAL: COPPER ALLOY
3. LEAD PLATING: Sn/Pb SOLDER
4. DIMENSIONS ARE IN INCHES [MILLIMETERS].
5. DIMENSION DOES NOT INCLUDE MOLDFLASH OF 0.15mm PER SIDE.
6. DIMENSION DOES NOT INCLUDE MOLDFLASH OF 0.25mm PER SIDE.
7. ALL GROUND LEADS MUST BE SOLDERED TO PCB RF GROUND.

Package Information

Part Number	Package Body Material	Lead Finish	MSL Rating	Package Marking
HMC476SC70	Low Stress Injection Molded Plastic	Sn/Pb Solder	MSL1 ^[1]	476
HMC476SC70E	RoHS-compliant Low Stress Injection Molded Plastic	100% matte Sn	MSL1 ^[2]	476E

[1] Max peak reflow temperature of 235 °C

[2] Max peak reflow temperature of 260 °C

For price, delivery and to place orders: Hittite Microwave Corporation, 20 Alpha Road, Chelmsford, MA 01824

Phone: 978-250-3343 Fax: 978-250-3373 Order On-line at www.hittite.com

Application Support: Phone: 978-250-3343 or apps@hittite.com

Pin Descriptions

Pin Number	Function	Description	Interface Schematic
1, 2, 4, 5	GND	These pins must be connected to RF/DC ground.	
3	RFIN	This pin is DC coupled. An off chip DC blocking capacitor is required.	
6	RFOUT	RF output and DC Bias (Vcc) for the output stage.	

Application Circuit

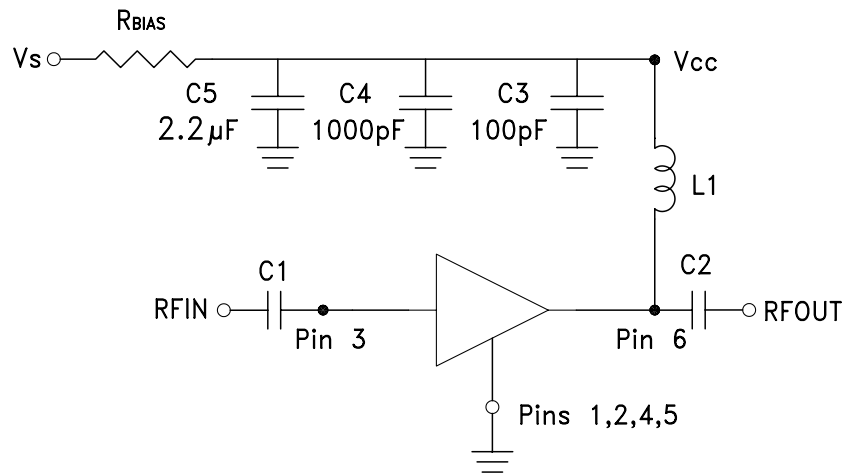

Recommended Bias Resistor Values for $I_{CC} = 35$ mA, $R_{bias} = (V_s - V_{CC}) / I_{CC}$

Supply Voltage (V_s)	5V	8V	10V	12V
R_{BIAS} VALUE	56 Ω	130 Ω	180 Ω	240 Ω
R_{BIAS} POWER RATING	1/8 W	1/4 W	1/4 W	1/2 W

Note:

- External blocking capacitors are required on R_{FIN} and R_{FOUT} .
- R_{BIAS} provides DC bias stability over temperature.

Recommended Component Values for Key Application Frequencies

Component	Frequency (MHz)							
	50	900	1900	2200	2400	3500	5200	5800
L1	270 nH	56 nH	18 nH	18 nH	15 nH	8.2 nH	6.8 nH	3.3 nH
C1, C2	0.01 μ F	100 pF	100 pF	100 pF	100 pF	100 pF	100 pF	100 pF

Evaluation PCB

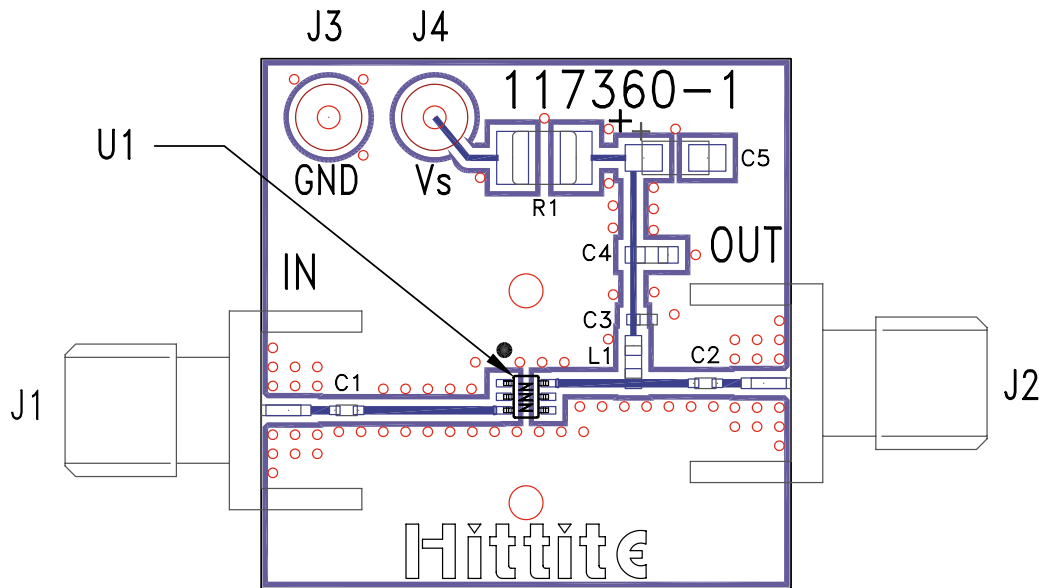

List of Materials for Evaluation PCB 118038 [1]

Item	Description
J1 - J2	PCB Mount SMA Connector
J3 - J4	DC Pin
C1 - C3	100 pF Capacitor, 0402 Pkg.
C4	1000 pF Capacitor, 0603 Pkg.
C5	2.2 μ F Capacitor, Tantalum
R1	50 Ohm Resistor, 1210 Pkg.
L1	18 nH Inductor, 0603 Pkg.
U1	HMC476SC70(E)
PCB [2]	117360 Evaluation PCB

[1] Reference this number when ordering complete evaluation PCB

[2] Circuit Board Material: Rogers 4350

The circuit board used in the application should use RF circuit design techniques. Signal lines should have 50 Ohm impedance while the package ground leads should be connected directly to the ground plane similar to that shown. A sufficient number of via holes should be used to connect the top and bottom ground planes. The evaluation board should be mounted to an appropriate heat sink. The evaluation circuit board shown is available from Hittite upon request.