

### Typical Applications

The HMC550 / HMC550E is ideal for:

- RFID & Electronic Toll Collection (ETC)
- Tags, Handsets & Portables
- ISM, WLAN, WiMAX & WiBro
- Automotive Telematics
- Test Equipment

### Features

- Failsafe Operation - "On" When Unpowered
- Wide Vdd Range: 1.2V to 5V
- Very Low On State Current: 200 nA
- Low Insertion Loss: 0.7 dB
- High IP3: +52 dBm
- Compact SOT26 SMT Package

### Functional Diagram

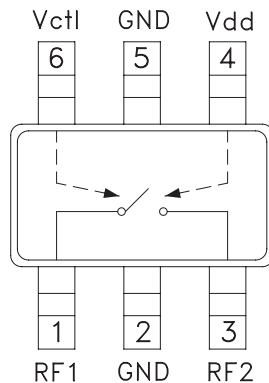

### General Description

The HMC550 and HMC550E are low-cost SPST Failsafe switches in 6-lead SOT26 plastic packages for use in switching applications which require low insertion loss and very low current consumption. With 0.7 dB typical loss, these devices can control signals from DC to 6 GHz and are especially suited for IF and RF applications including RFID, ISM, automotive and battery powered tags and portables. RF1 and RF2 are reflective opens when "Off". The switch requires a minimal amount of DC current in the "On" state, and offers compatibility with CMOS and some TTL logic families. The failsafe topology results in the switch being normally "On", i.e. low insertion loss from RF1 to RF2, when no DC bias is applied.

### Electrical Specifications

$T_A = +25^\circ \text{C}$ ,  $V_{dd} = +3.3 \text{Vdc}$ ,  $V_{ctl} = 0/+3.3 \text{Vdc}$  (Unless Otherwise Stated), 50 Ohm System

Parameter	Frequency	Min.	Typ.	Max.	Units
Insertion Loss	DC - 6.0 GHz		0.7	0.9	dB
Isolation	DC - 2.0 GHz	15	25		dB
	DC - 6.0 GHz	8	12		dB
Return Loss	DC - 6.0 GHz		20		dB
Input Power for 0.1 dB Compression	$V_{ctl} = 0/+3.3\text{V}$ 0.5 - 6.0 GHz	23	27		dBm
Input Third Order Intercept (Two-tone Input Power = +17 dBm Each Tone)	$V_{ctl} = 0/+3.3\text{V}$ 0.5 - 6.0 GHz		52		dBm
Switching Characteristics	DC - 6.0 GHz	$t_{RISE}, t_{FALL}$ (10/90% RF)	40		ns
		$t_{ON}, t_{OFF}$ (50% CTL to 10/90% RF)	50		ns

### $T_A = +25^\circ \text{C}$ , $V_{ctl}$ & $V_{dd}$ Unpowered

Insertion Loss	DC - 6.0 GHz		0.7	0.9	dB
Return Loss	DC - 6.0 GHz		20		dB
Input Power for 0.1 dB Compression	0.5 - 6.0 GHz	23	27		dBm
Input Third Order Intercept (Two-tone Input Power = +17 dBm Each Tone)	0.5 - 0.6 GHz		52		dBm



**Insertion Loss**

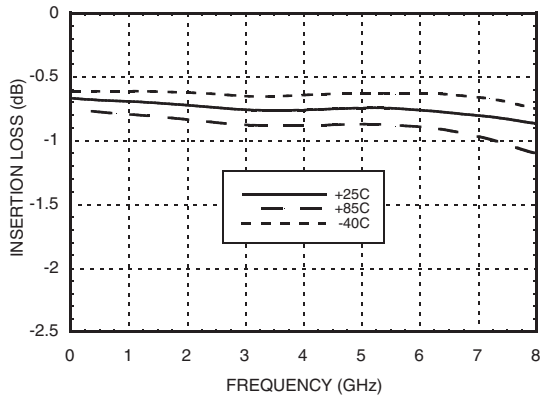

**Return Loss**

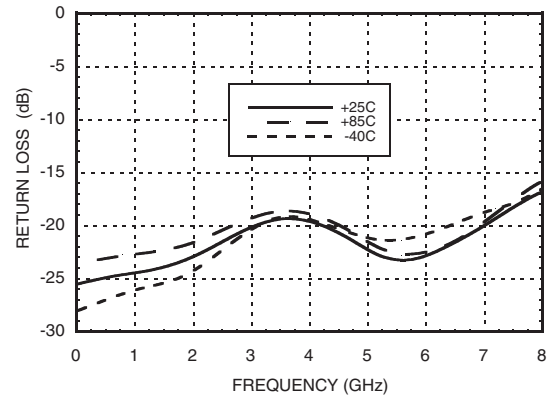

**Isolation**

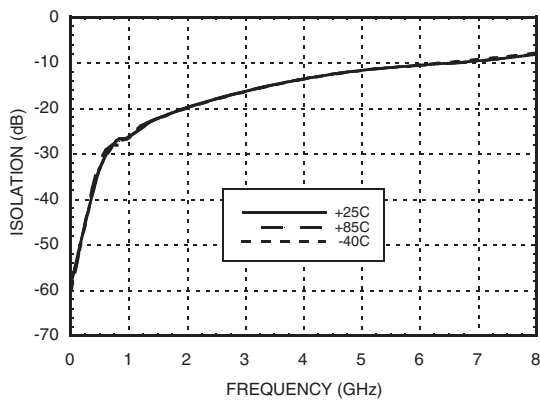

**Input IP3 vs. Temperature**

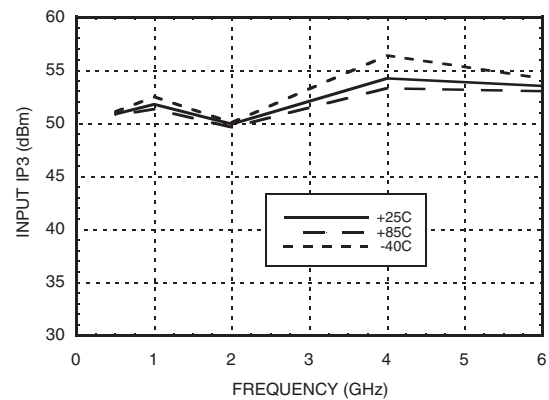

**Input P0.1dB vs. Temperature**

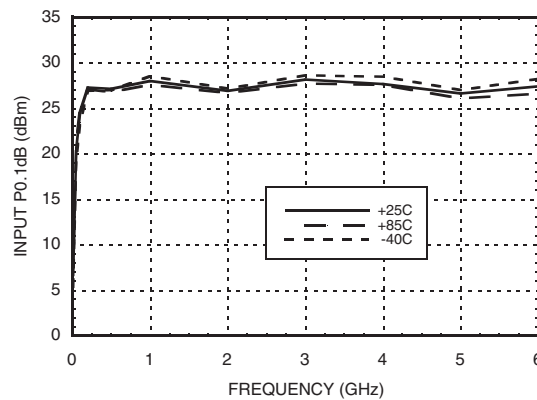

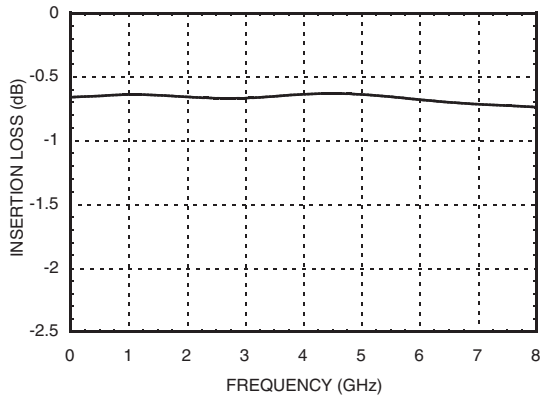
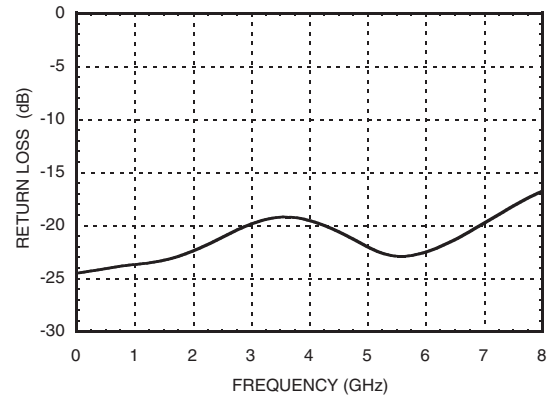
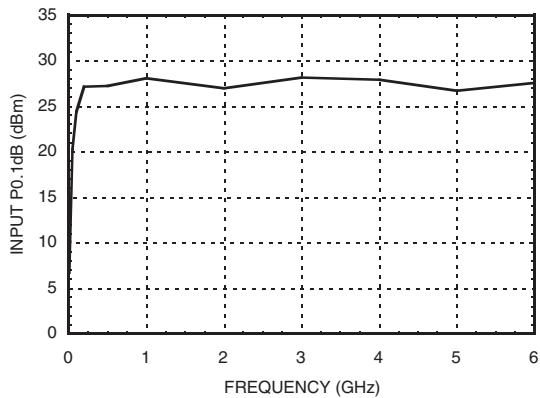
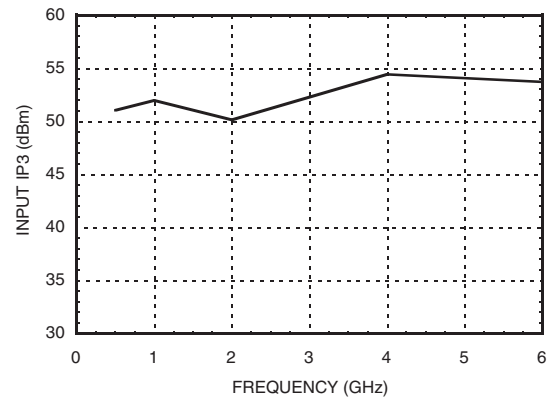
**Insertion Loss, Power Off**

**Return Loss, Power Off**

**Input P0.1dB, Power Off**

**Input IP3, Power Off**

**Operating Conditions**
**Vdd & Vctl = 0 Vdc to +5 Vdc; Vctl\_max = Vdd + 0.2 Vdc; Idd & Ictl = 0.1 μA, Typical**

Conditions	Vdd - Vctl ≥ + 1.2 Vdc	-0.2 Vdc < Vdd - Vctl < +0.4 Vdc
RF1 - RF2	OFF	ON

**Examples of Typical Operating Conditions - Idd & Ictl = 0.1 μA, Typical**

Vdd (V)	0 (Unpowered)	1.2		2.2		3.3		5.0	
Vctl (V)	0 (Unpowered)	0	> 0.8	< 1.0	> 1.8	< 2.1	> 2.9	< 3.8	> 4.6
RF1 - RF2	ON	OFF	ON	OFF	ON	OFF	ON	OFF	ON

### Absolute Maximum Ratings

RF Input Power (Vctl = 0/+3.3V)	+34 dBm
Supply Voltage (Vdd)	+12 Vdc
Control Voltage Range (Vctl)	-0.2 to +(Vdd + 0.2) Vdc
Hot Switch Power Level (Vctl = 0/+3.3V)	+35 dBm
Channel Temperature	150 °C
Continuous Pdiss (T= 85 °C) (derate 6.67 mW/ °C above 85°C)	433 mW
Thermal Resistance	150 °C/W
Storage Temperature	-65 to +150 °C
Operating Temperature	-40 to +85 °C

DC blocks are required at ports RF1 and RF2.



ELECTROSTATIC SENSITIVE DEVICE  
OBSERVE HANDLING PRECAUTIONS

### Outline Drawing

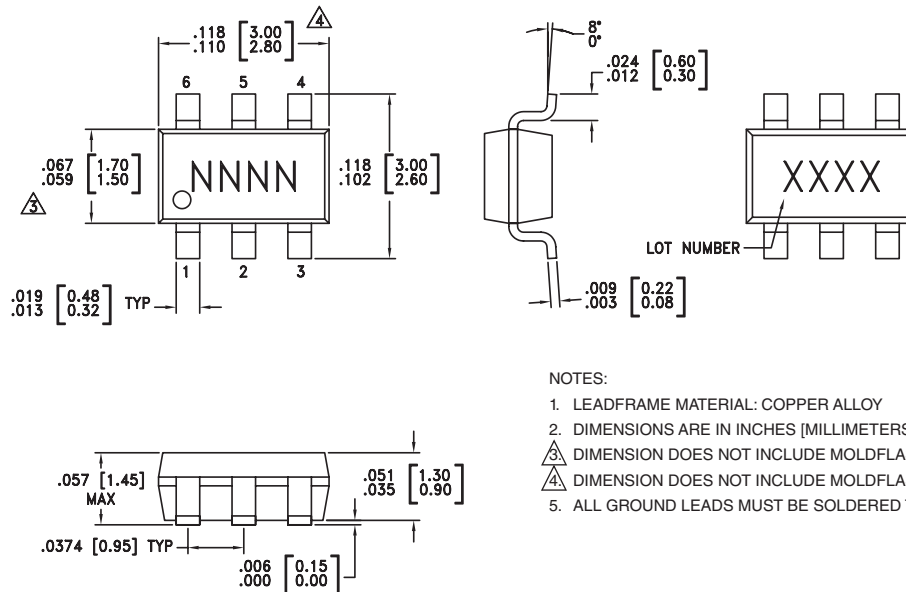

#### NOTES:

- LEADFRAME MATERIAL: COPPER ALLOY
- DIMENSIONS ARE IN INCHES [MILLIMETERS].
- ⚠ DIMENSION DOES NOT INCLUDE MOLDFLASH OF 0.15mm PER SIDE.
- ⚠ DIMENSION DOES NOT INCLUDE MOLDFLASH OF 0.25mm PER SIDE.
- ALL GROUND LEADS MUST BE SOLDERED TO PCB RF GROUND.

### Package Information

Part Number	Package Body Material	Lead Finish	MSL Rating	Package Marking
HMC550	Low Stress Injection Molded Plastic	Sn/Pb Solder	MSL1 <sup>[1]</sup>	H550
HMC550E	RoHS-compliant Low Stress Injection Molded Plastic	100% matte Sn	MSL1 <sup>[2]</sup>	550E

[1] Max peak reflow temperature of 235 °C

[2] Max peak reflow temperature of 260 °C

### Pin Descriptions

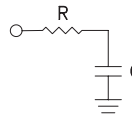
Pin Number	Function	Description	Interface Schematic
1, 3	RF1, RF2	These pins are DC coupled and matched to 50 Ohms. Blocking capacitors are required.	
2, 5	GND	These pins must be connected to RF ground.	
4	Vdd	Supply Voltage	
6	Vctl	See truth and control voltage tables.	

### Typical Application Circuit

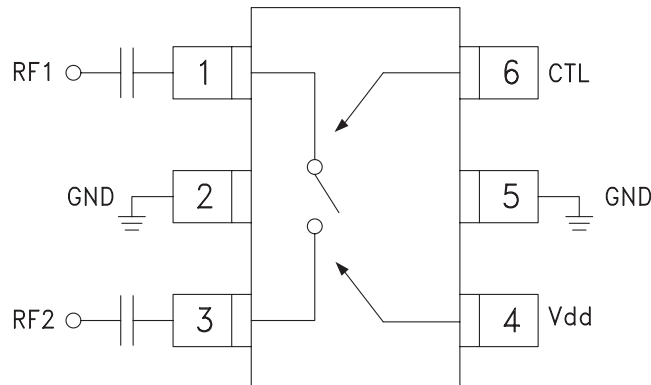

**Note:**

- DC Blocking capacitors are required for each RF port as shown. Capacitor value determines lowest frequency of operation.

**Evaluation PCB**

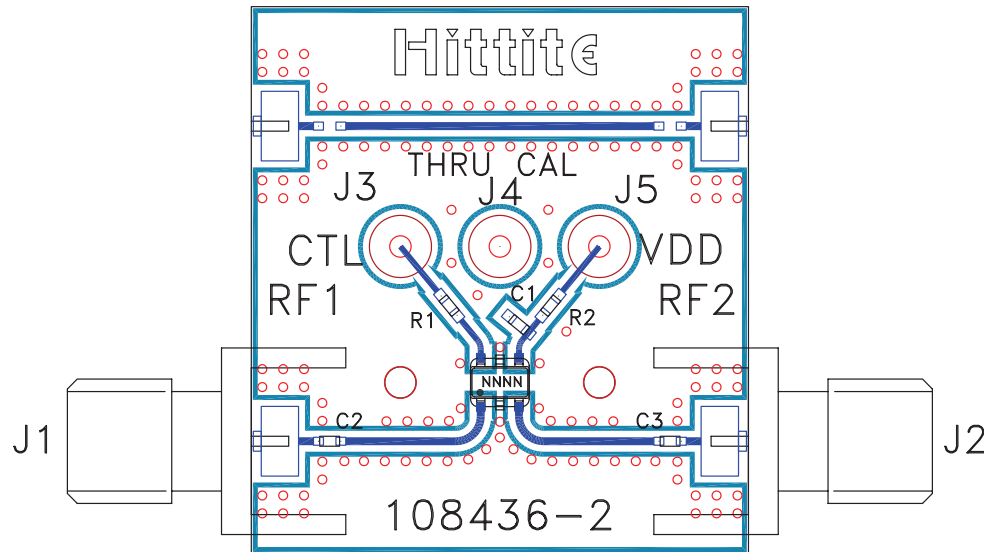

**List of Materials for Evaluation PCB 109266 [1]**

Item	Description
J1 - J2	PCB Mount SMA RF Connector
J3 - J5	DC Pin
C1	1,000 pF Capacitor, 0402 Pkg.
C2 - C3	100 pF capacitor, 0402 Pkg.
R1, R2	100 Ohm Resistor, 0402 Pkg.
U1	HMC550 / HMC550E SPST Switch
PCB [2]	108436 Evaluation PCB

[1] Reference this number when ordering complete evaluation PCB

[2] Circuit Board Material: Rogers 4350

The circuit board used in the final application should be generated with proper RF circuit design techniques. Signal lines at the RF port should have 50 Ohm impedance and the package ground leads should be connected directly to the ground plane similar to that shown above. The evaluation circuit board shown above is available from Hittite Microwave Corporation upon request.