

## GaAs MMIC x2 ACTIVE FREQUENCY MULTIPLIER, 22 - 46 GHz OUTPUT

### Typical Applications

The HMC598 is ideal for:

- Clock Generation Applications: OC-768 & SDM STM-256
- Point-to-Point & VSAT Radios
- Test Instrumentation
- Military & Space

### Features

- High Output Power: +15 dBm
- Low Input Power Drive: 0 to +6 dBm
- Fo Isolation: 25 dBc @ Fout = 30 GHz
- Die Size: 2.07 x 1.86 x 0.1 mm

### Functional Diagram

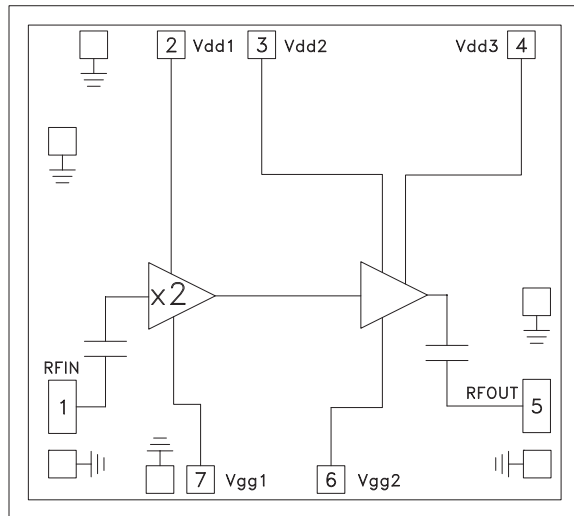

### General Description

The HMC598 is a x2 active broadband frequency multiplier chip utilizing GaAs PHEMT technology. When driven by a +5 dBm signal, the multiplier provides +15 dBm typical output power from 22 to 46 GHz and the Fo and 3Fo isolations are 25 dBc and 15 dBc respectively at 30 GHz. The HMC598 is ideal for use in LO multiplier chains for Point to Point and VSAT radios yielding reduced parts count versus traditional design approaches.

### Electrical Specifications

$T_A = +25^\circ\text{C}$ , Vdd1, 2, 3 = +5V, Vgg1 = -1.25V, Vgg2 = -0.8V, 5 dBm Drive Level

Parameter	Min.	Typ.	Max.	Units
Frequency Range, Input	11 - 23			GHz
Frequency Range, Output	22 - 46			GHz
Output Power	10	15		dBm
Fo Isolation (with respect to output level)		20		dBc
3Fo Isolation (with respect to output level)		10		dBc
4Fo Isolation (with respect to output level)		5		dBc
Input Return Loss		10		dB
Output Return Loss		13		dB
Supply Current (Idd Total)		175		mA

**GaAs MMIC x2 ACTIVE FREQUENCY MULTIPLIER, 22 - 46 GHz OUTPUT**

**Output Power vs. Temperature @ 5 dBm Drive Level**

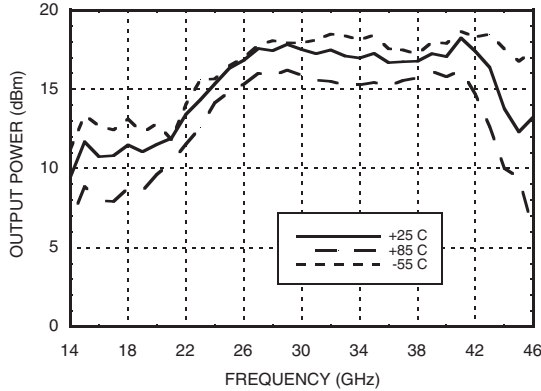

**Output Power vs. Drive Level**

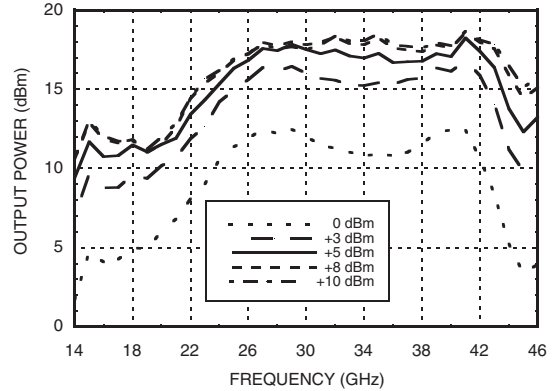

**Output Power vs. Supply Voltage @ 5 dBm Drive Level**

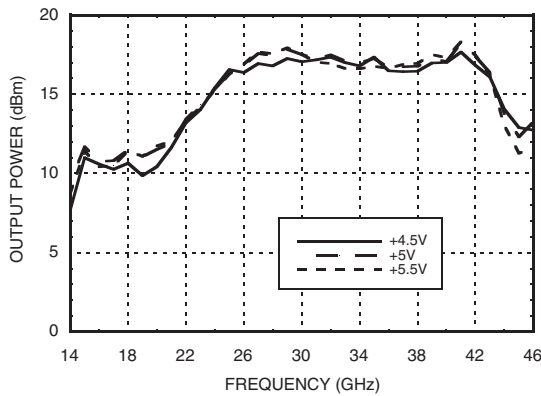

**Isolation @ 5 dBm Drive Level**

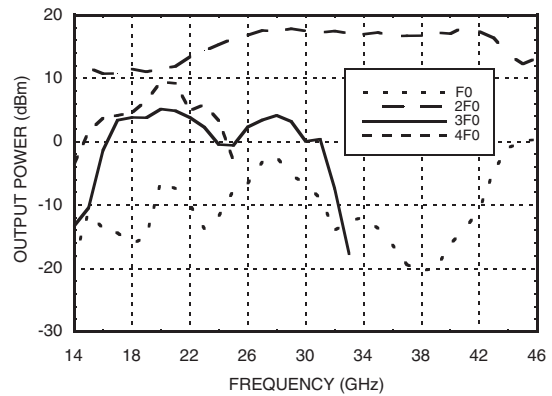

**Output Power vs. Input Power**

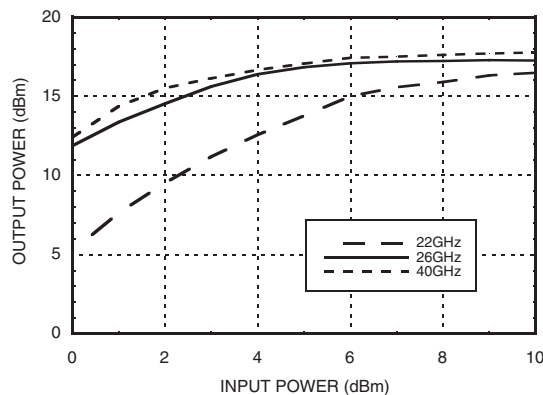

**GaAs MMIC x2 ACTIVE FREQUENCY MULTIPLIER, 22 - 46 GHz OUTPUT**

2

FREQUENCY MULTIPLIERS - ACTIVE - CHIP

**Input Return Loss vs. Temperature**

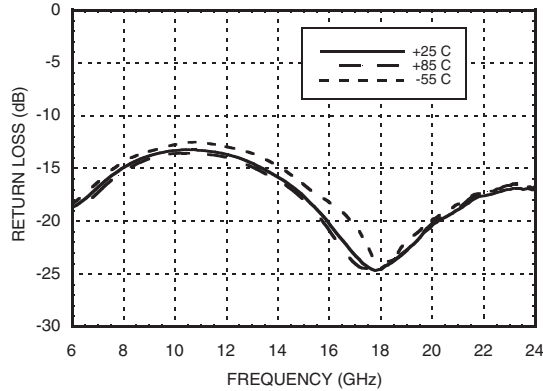

**Output Return Loss vs. Temperature**

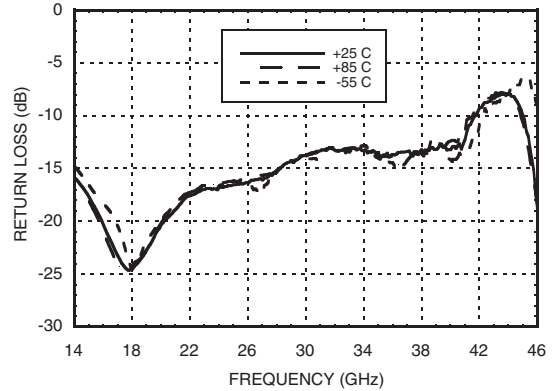

**Supply Current vs. Input Power**

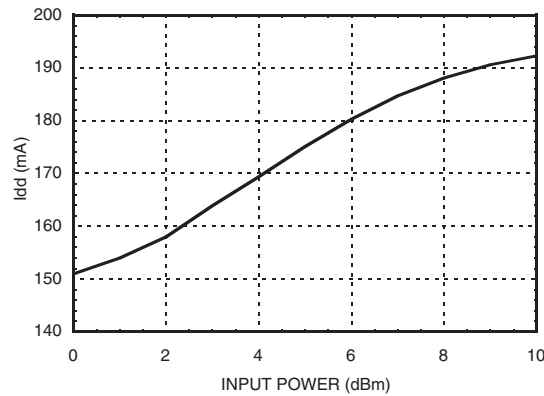

**Absolute Maximum Ratings**

RF Input (Vdd1, 2, 3 = +5V)	+10 dBm
Supply Voltage (Vdd1,2, 3)	+6 Vdc
Channel Temperature	175 °C
Continuous Pdiss (T= 85 °C) (derate 12.7 mW/°C above 85 °C)	1.14 W
Thermal Resistance (channel to die bottom)	79 °C/W
Storage Temperature	-65 to +150 °C
Operating Temperature	-55 to +85 °C

**Typical Supply Current vs. Vdd1, Vdd2, Vdd3**

Vdd1, 2, 3 (Vdc)	Idd1 + Idd2 + Idd3(mA)
4.5	170
5.0	175
5.5	180

Note:  
Multiplier will operate over full voltage range shown above.



**ELECTROSTATIC SENSITIVE DEVICE  
OBSERVE HANDLING PRECAUTIONS**

**GaAs MMIC x2 ACTIVE FREQUENCY MULTIPLIER, 22 - 46 GHz OUTPUT**

**Outline Drawing**

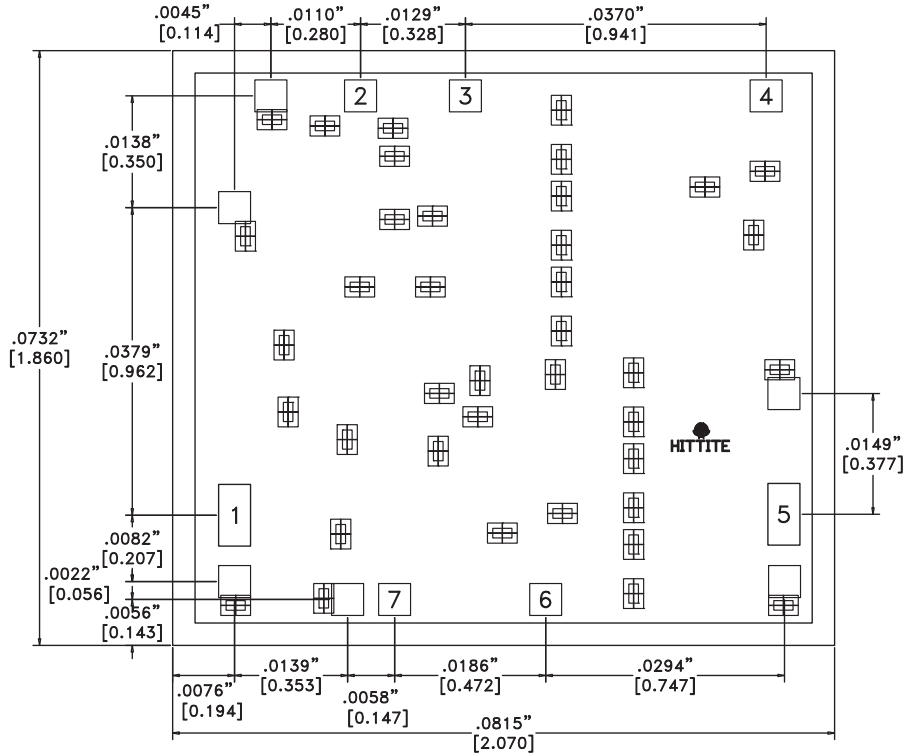

**Die Packaging Information** [1]

Standard	Alternate [2]
GP-1 (Gel Pack)	—

[1] Refer to the “Packaging Information” section for die packaging dimensions.

[2] Reference this suffix only when ordering alternate die packaging.

**Pin Description**

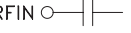
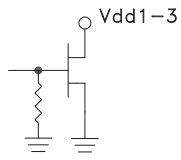
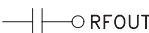
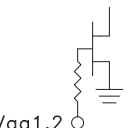

Pin Number	Function	Description	Interface Schematic
1	RFIN	Pin is AC coupled and matched to 50 Ohms.	
2 - 4	Vdd1, Vdd2, Vdd3	Power supply voltage. See Assembly Diagram for external components.	
5	RFOUT	Pin is AC coupled and matched to 50 Ohms.	
6, 7	Vgg2, Vgg1	Gate control for multiplier. Please follow “MMIC Amplifier Biasing Procedure” Application note. See Assembly Diagram for required external components.	

For price, delivery and to place orders: Hittite Microwave Corporation, 20 Alpha Road, Chelmsford, MA 01824  
 Phone: 978-250-3343 Fax: 978-250-3373 Order On-line at [www.hittite.com](http://www.hittite.com)  
 Application Support: Phone: 978-250-3343 or [apps@hittite.com](mailto:apps@hittite.com)

**GaAs MMIC x2 ACTIVE FREQUENCY MULTIPLIER, 22 - 46 GHz OUTPUT**

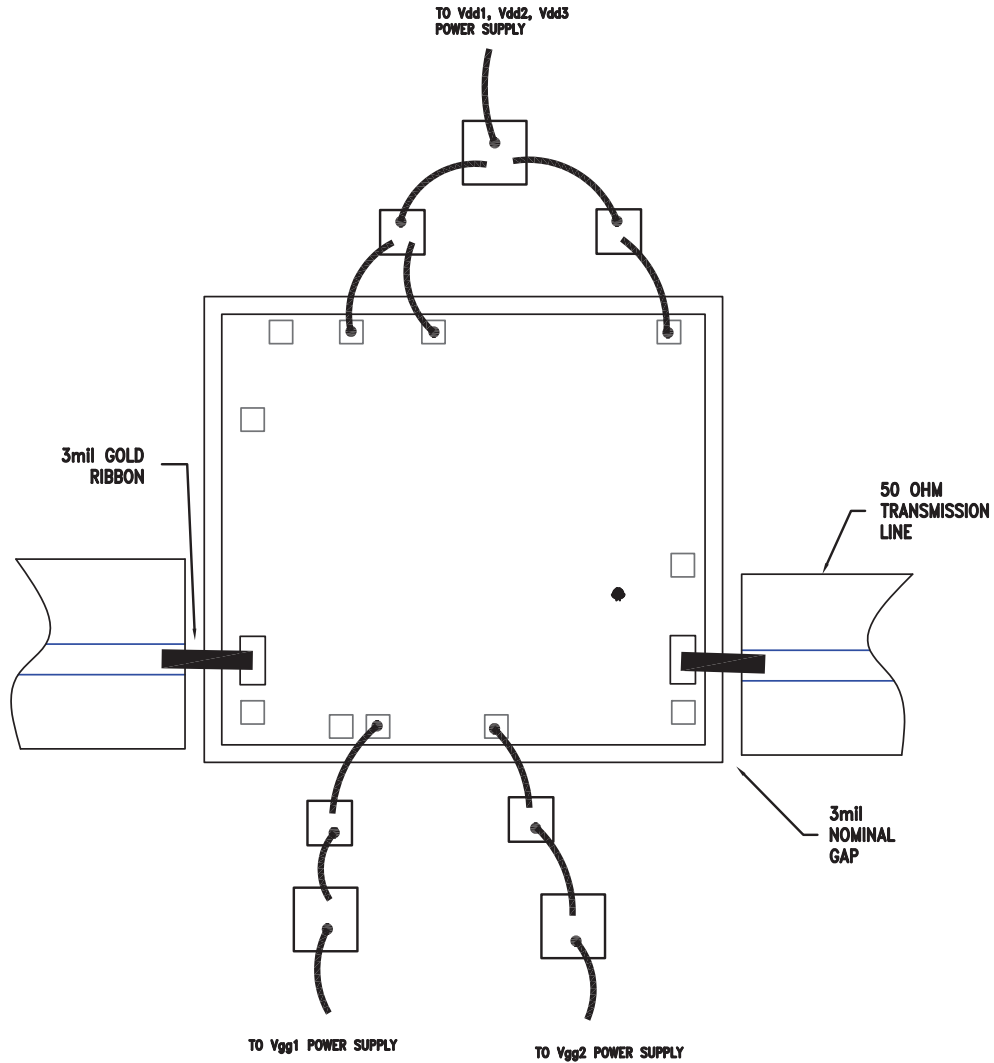
**Assembly Diagram**



-  0.1uF BYPASS CAPACITOR
-  100pF BYPASS CAPACITOR

**GaAs MMIC x2 ACTIVE FREQUENCY MULTIPLIER, 22 - 46 GHz OUTPUT**

**Mounting & Bonding Techniques for Millimeterwave GaAs MMICs**

The die should be attached directly to the ground plane eutectically or with conductive epoxy (see HMC general Handling, Mounting, Bonding Note).

50 Ohm Microstrip transmission lines on 0.127mm (5 mil) thick alumina thin film substrates are recommended for bringing RF to and from the chip (Figure 1). If 0.254mm (10 mil) thick alumina thin film substrates must be used, the die should be raised 0.150mm (6 mils) so that the surface of the die is coplanar with the surface of the substrate. One way to accomplish this is to attach the 0.102mm (4 mil) thick die to a 0.150mm (6 mil) thick molybdenum heat spreader (moly-tab) which is then attached to the ground plane (Figure 2).

Microstrip substrates should be brought as close to the die as possible in order to minimize ribbon bond length. Typical die-to-substrate spacing is 0.076mm (3 mils). Gold ribbon of 0.075 mm (3 mil) width and minimal length <0.31 mm (<12 mils) is recommended to minimize inductance on RF, LO & IF ports.

An RF bypass capacitor should be used on the Vdd input. A 100 pF single layer capacitor (mounted eutectically or by conductive epoxy) placed no further than 0.762mm (30 Mils) from the chip is recommended.

**Handling Precautions**

Follow these precautions to avoid permanent damage.

**Storage:** All bare die are placed in either Waffle or Gel based ESD protective containers, and then sealed in an ESD protective bag for shipment. Once the sealed ESD protective bag has been opened, all die should be stored in a dry nitrogen environment.

**Cleanliness:** Handle the chips in a clean environment. DO NOT attempt to clean the chip using liquid cleaning systems.

**Storage:** All bare die are placed in either Waffle or Gel based ESD protective containers, and then sealed in an ESD protective bag for shipment. Once the sealed ESD protective bag has been opened, all die should be stored in a dry nitrogen environment.

**Static Sensitivity:** Follow ESD precautions to protect against > ± 250V ESD strikes.

**Transients:** Suppress instrument and bias supply transients while bias is applied. Use shielded signal and bias cables to minimize inductive pick-up.

**General Handling:** Handle the chip along the edges with a vacuum collet or with a sharp pair of bent tweezers. The surface of the chip may have fragile air bridges and should not be touched with vacuum collet, tweezers, or fingers.

**Mounting**

The chip is back-metallized and can be die mounted with AuSn eutectic preforms or with electrically conductive epoxy. The mounting surface should be clean and flat.

**Eutectic Die Attach:** A 80/20 gold tin preform is recommended with a work surface temperature of 255 deg. C and a tool temperature of 265 deg. C. When hot 90/10 nitrogen/hydrogen gas is applied, tool tip temperature should be 290 deg. C. DO NOT expose the chip to a temperature greater than 320 deg. C for more than 20 seconds. No more than 3 seconds of scrubbing should be required for attachment.

**Epoxy Die Attach:** Apply a minimum amount of epoxy to the mounting surface so that a thin epoxy fillet is observed around the perimeter of the chip once it is placed into position. Cure epoxy per the manufacturer's schedule.

**Wire Bonding**

Ball or wedge bond with 0.025mm (1 mil) diameter pure gold wire. Thermosonic wirebonding with a nominal stage temperature of 150 deg. C and a ball bonding force of 40 to 50 grams or wedge bonding force of 18 to 22 grams is recommended. Use the minimum level of ultrasonic energy to achieve reliable wirebonds. Wirebonds should be started on the chip and terminated on the package or substrate. All bonds should be as short as possible <0.31mm (12 mils).

