



Typical Applications

The HMC623LP4 / HMC623LP4E is ideal for:

- Cellular/3G & LTE/WiMAX/4G
- Base Stations & Repeaters
- WiMAX & WiBro
- Broadband & Fixed Wireless
- Test & Measurement Equipment

Features

- Low Noise Figure: 4 dB
- High Output IP3: +39 dBm
- Low Input LO Drive: 0 dBm
- High LO to RF Isolation: 45 dB
- High Conversion Gain: 33 dB
- 24 Lead 4x4mm SMT Package: 16mm²

Functional Diagram

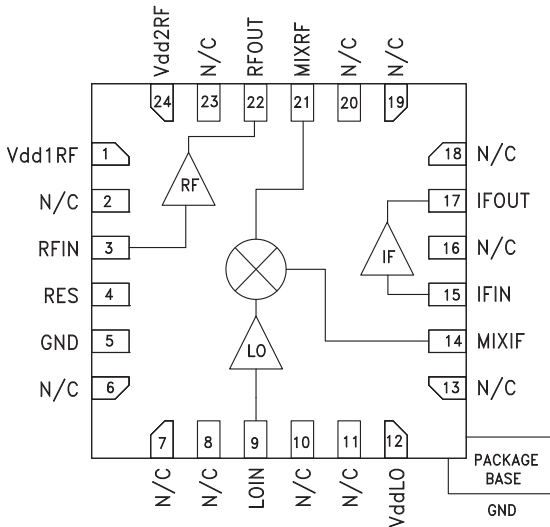

General Description

The HMC623LP4E is a highly integrated downconverter IC that operates from 1.8 to 2.7 GHz. The HMC623LP4E incorporates a high dynamic range, single-balanced mixer core with integrated RF, LO and IF amplifiers, making it ideal for compact transceiver applications in GSM, WCDMA, TD-SCDMA, WiBro and WiMAX. This versatile converter RFIC operates with a low LO input power level of only 0 dBm, provides up to 33 dB conversion gain, and exhibits +39 dBm Output IP3. The integrated RF amplifier provides for an overall noise figure of only 4 dB.

Electrical Specifications, $T_A = +25\text{ }^\circ\text{C}$, $IF = 200\text{ MHz}$, $LO = 0\text{ dBm}$, $V_{bias}^{[1]} = +5V$ ^[2]

Parameter	Min.	Typ.	Max.	Min.	Typ.	Max.	Units
Frequency Range, RF	1.8 - 2.2		2.2 - 2.7				GHz
Frequency Range, IF	50 - 650		50 - 650				MHz
Frequency Range, LO	1.6 - 2.0		2.0 - 2.5				GHz
Conversion Gain	30	33		23	28		dB
Noise Figure (SSB)		4			4		dB
LO to RF Isolation	39	45		31	38		dB
IP3 (Output)		34			39		dBm
1 dB Compression (Output)		19			20		dBm
LO Drive Input Level (Typical)	-3 to +3		-3 to +3				dBm
Supply Current (IBIAS)		250	310		245	310	mA

[1] See Application circuit

[2] Unless otherwise noted, all measurements performed as a downconverter with low side LO & IF= 200 MHz



Conversion Gain vs. Temperature

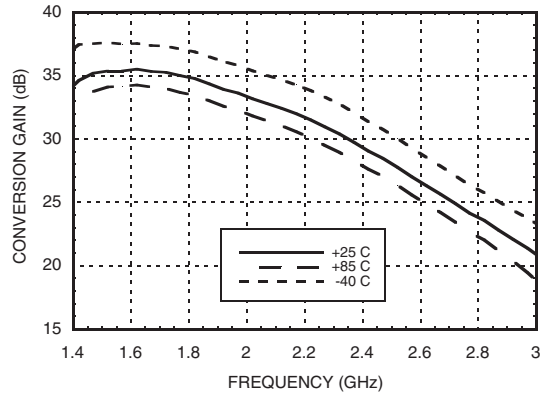

Isolation

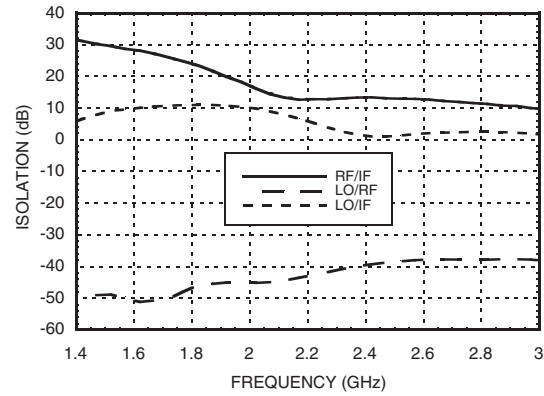

Conversion Gain vs. LO Drive

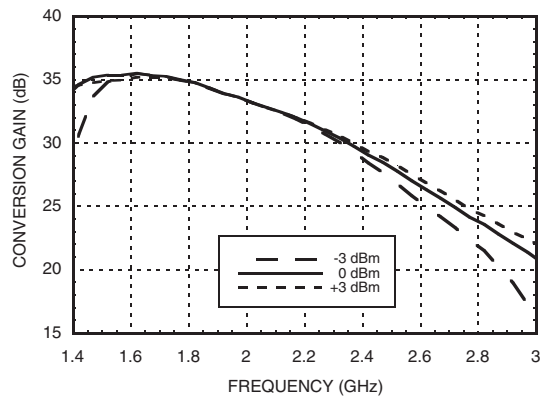

Return Loss

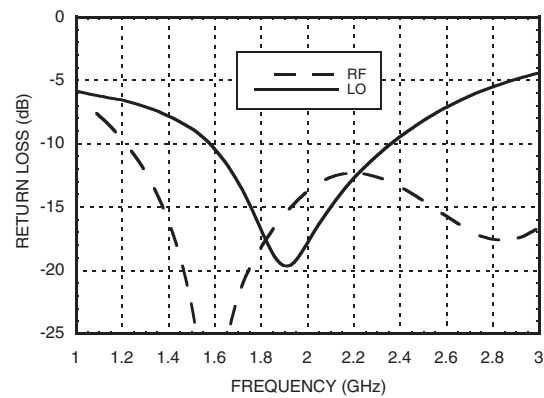

Conversion Gain vs. IF Frequency

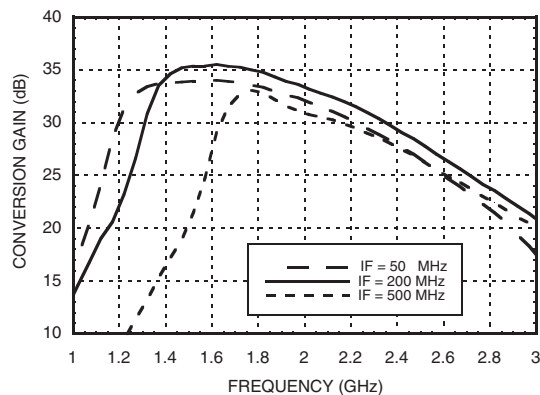

IF Bandwidth, LO = 1.9 GHz

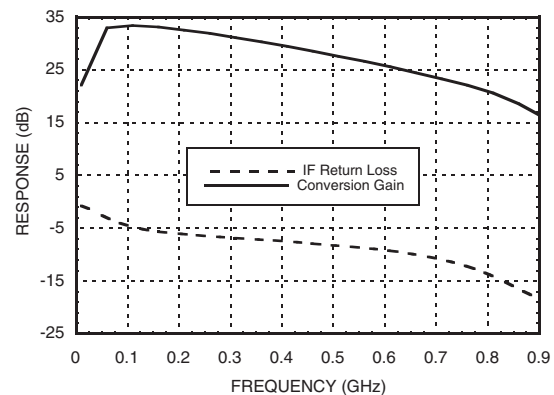



Output IP3 vs. Temperature

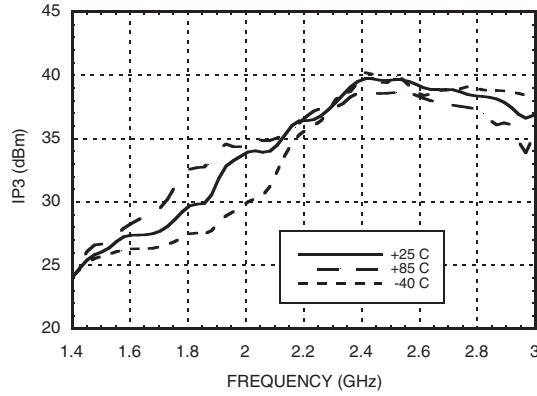

Output IP2 vs. Temperature

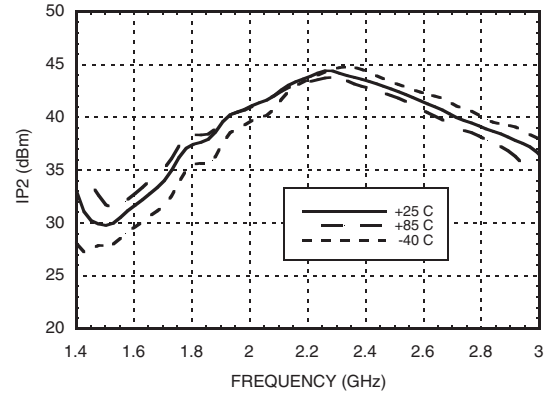

Output IP3 vs. LO Drive

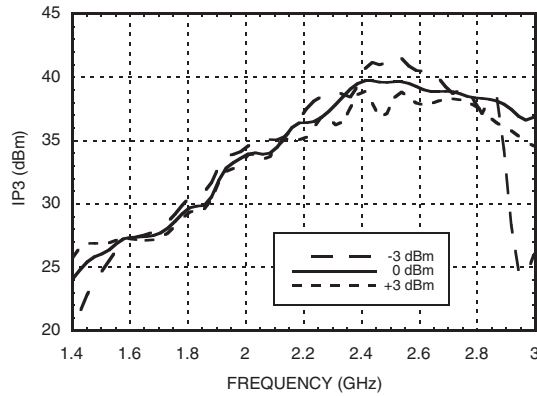

Output IP2 vs. LO Drive

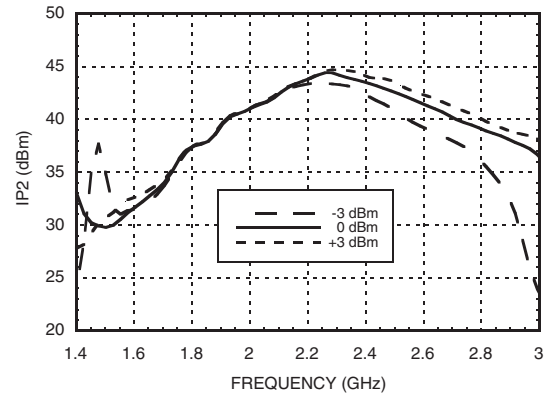

Output IP3 vs. IF Frequency

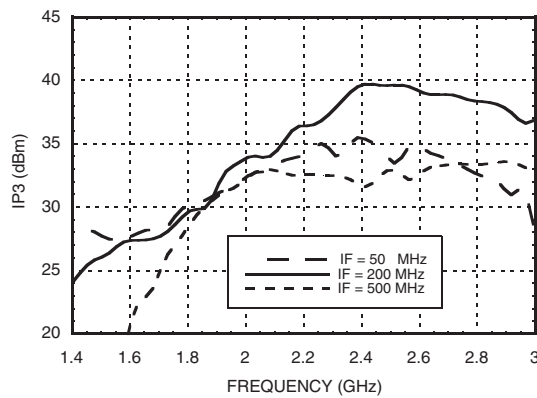

Output P1dB vs. Temperature

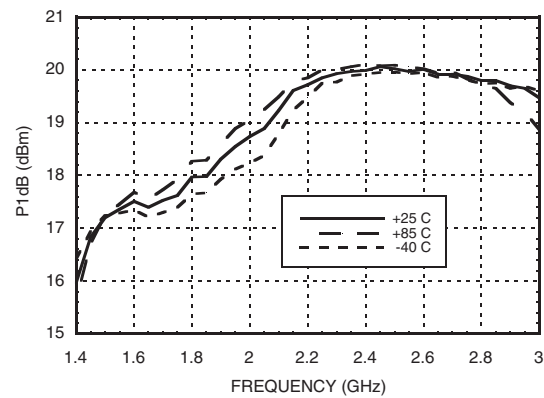



Noise Figure vs. Temperature

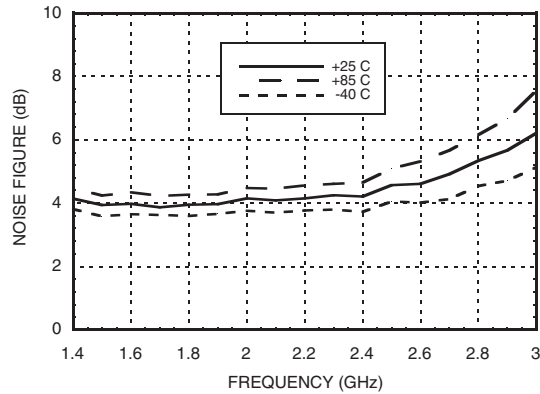

Absolute Maximum Ratings

RF / IF Input (Vbias = +5V)	+10 dBm
LO Drive (Vbias = +5V)	+10 dBm
Vbias	+5.5 Vdc
Junction Temperature	150 °C
Continuous P _{diss} (T = 85°C) (derate 21.8 mW/°C above 85°C)	1.42 W
Thermal Resistance (junction to ground paddle)	45.7 °C/W
Storage Temperature	-65 to +150°C
Operating Temperature	-40 to +85°C

Typical Supply Current

Vbias (V)	Ibias (mA)
4.5	205
5.0	250
5.5	300



ELECTROSTATIC SENSITIVE DEVICE
OBSERVE HANDLING PRECAUTIONS

Absolute Bias Resistor (R1)

Range & Recommended Bias Resistor Values for I_{dd} RF [3]

Vbias (V)	Rbias (R1)			I _{dd} RF
	Min (Ohms)	Max (Ohms)	R1 Ohms	
5V	0	Open Circuit	120	71
			470	89
			10k	117

[3] External bias resistor R1 sets the DC current of the RF Amp

Typical Performance Cascade Analysis

(RF = 1800 to 2200 MHz, IF = 50 to 300 MHz, LO = Low Side or High Side)

Description	Component Level					Cumulative MCM Performance				
	Gain (dB)	NF (dB)	OP1dB (dBm)	OIP3 (dBm)	+5V Current	Gain (dB)	OP1dB (dBm)	NF (dB)	OIP3 (dBm)	IIP3 (dBm)
RF LNA	19.5	0.8	20.0	36.0	117.0	19.5	20.0	0.8	36.0	16.5
RF Filter*	-1.5	1.5				18.0	18.5	0.8	34.5	16.5
Passive Mixer w/ LO Amp	-9.0	9.2	11.0	24.0	45.0	9.0	7.2	1.2	21.7	12.7
IF Amp	22.5	2.8	20.5	37.0	88.0	31.5	20.0	1.6	36.2	4.7
HMC623LP4	Cumulative MCM Performance				250.0	31.5	20.0	1.6	36.2	4.7

* RF image rejection filter is not included in the released eval boards.

Outline Drawing

9

MIXERS - DOWNCONVERTERS - SMT

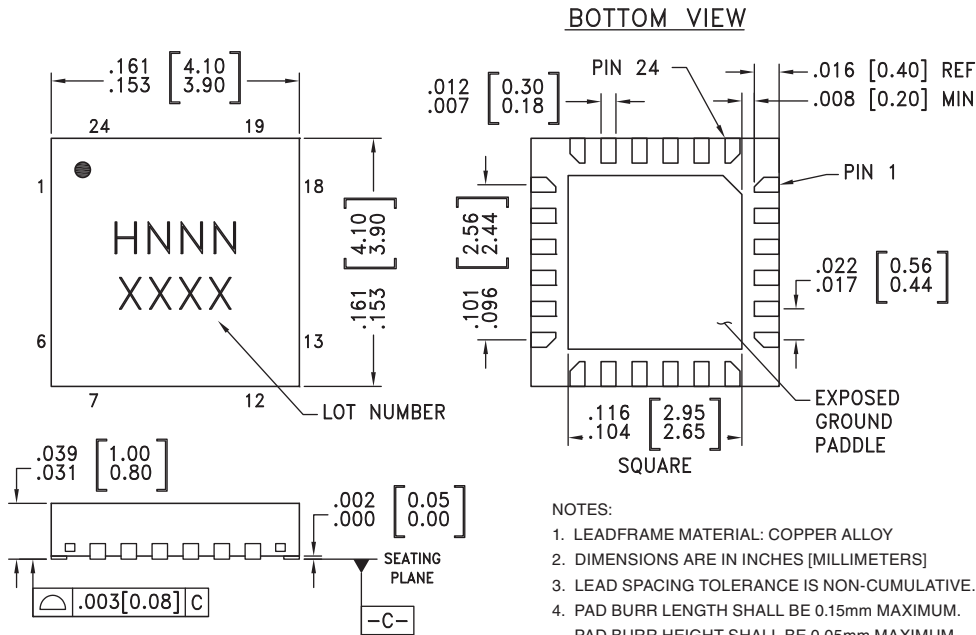

- NOTES:
1. LEADFRAME MATERIAL: COPPER ALLOY
 2. DIMENSIONS ARE IN INCHES [MILLIMETERS]
 3. LEAD SPACING TOLERANCE IS NON-CUMULATIVE.
 4. PAD BURR LENGTH SHALL BE 0.15mm MAXIMUM. PAD BURR HEIGHT SHALL BE 0.05mm MAXIMUM.
 5. PACKAGE WARP SHALL NOT EXCEED 0.05mm.
 6. ALL GROUND LEADS AND GROUND PADDLE MUST BE SOLDERED TO PCB RF GROUND.
 7. REFER TO HITTITE APPLICATION NOTE FOR SUGGESTED LAND PATTERN.





Package Information

Part Number	Package Body Material	Lead Finish	MSL Rating	Package Marking ^[3]
HMC623LP4	Low Stress Injection Molded Plastic	Sn/Pb Solder	MSL1 ^[1]	H623 XXXX
HMC623LP4E	RoHS-compliant Low Stress Injection Molded Plastic	100% matte Sn	MSL1 ^[2]	H623 XXXX

[1] Max peak reflow temperature of 235 °C
 [2] Max peak reflow temperature of 260 °C
 [3] 4-Digit lot number XXXX

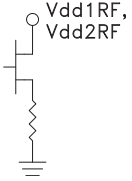
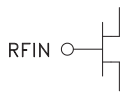
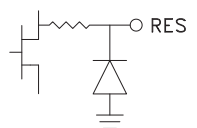

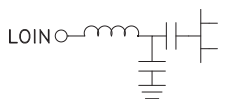
Pin Descriptions

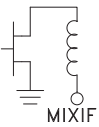
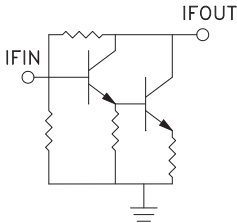
Pin Number	Function	Description	Interface Schematic
1	Vdd1RF	Power Supply Voltage for the RF amplifier. External bypass capacitors of 100 pF, 1000pF, and 2.2 μF are required.	
24	Vdd2RF		
2, 4, 6 - 8, 10, 11, 13, 16, 18 - 20, 23	N/C	No connection necessary. These pins may be connected to RF/DC Ground	
3	RFIN	This pin is DC coupled and matched to 50 Ohms.	
4	RES	This pin is used to set the DC current of the RF amplifier by selection of the external bias resistor. See application circuit and bias resistor value table.	
5	GND	Backside of package has exposed metal ground paddle that must also be connected to ground.	
9	LOIN	This pin is AC coupled and matched to 50 Ohms.	
12	VddLO	Power supply for LO amplifier. An external RF bypass capacitor is required.	
14	MIXIF	For applications not requiring operation to DC this port should be DC blocked externally using a series capacitor. Choose value of capacitor to pass IF frequency desired. For operation to DC, this pin must not sink/source more than 40 mA of current or failure may result.	
15	IFIN	This pin is DC coupled. An off chip DC blocking capacitor is required.	
17	IFOUT	IF output and DC Bias (Vcc) for the output stage.	

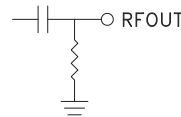

Pin Descriptions (Continued)

Pin Number	Function	Description	Interface Schematic
21	MIXRF	This pin is DC coupled and matched to 50 Ohms.	
22	RFOUT	This pin is matched to 50 Ohms.	

Application Circuit

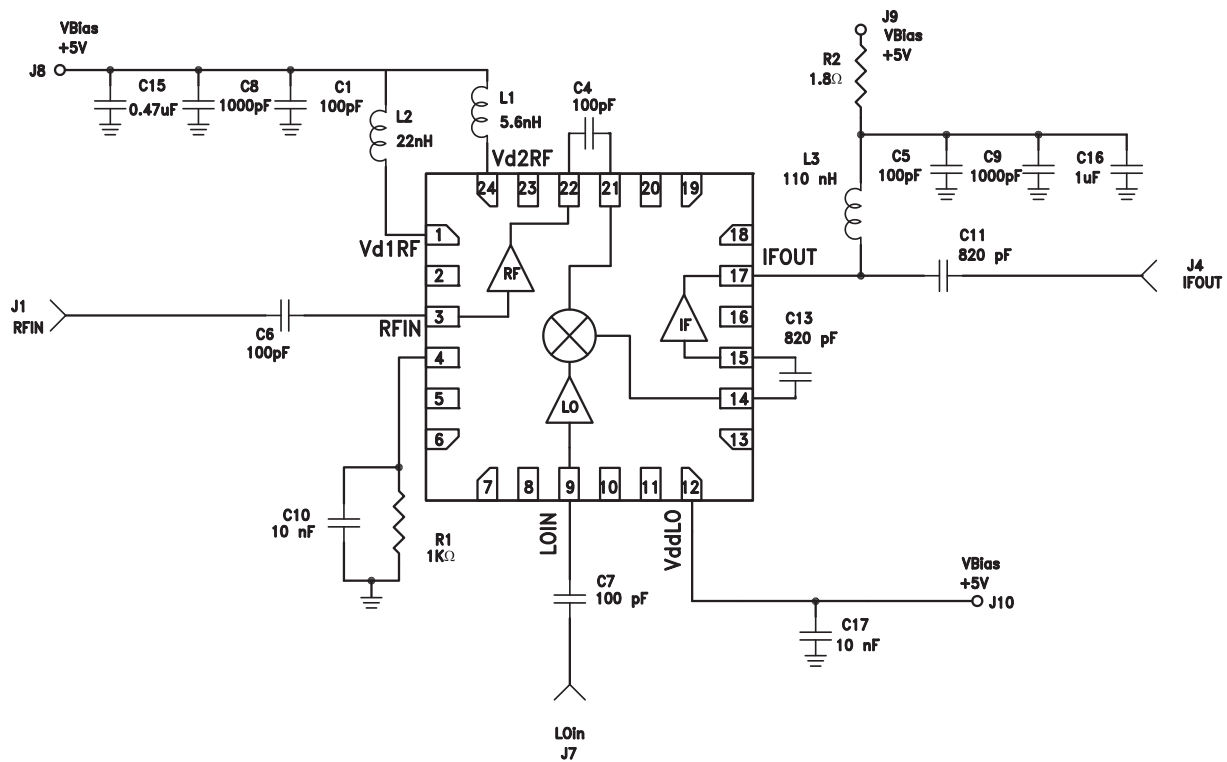

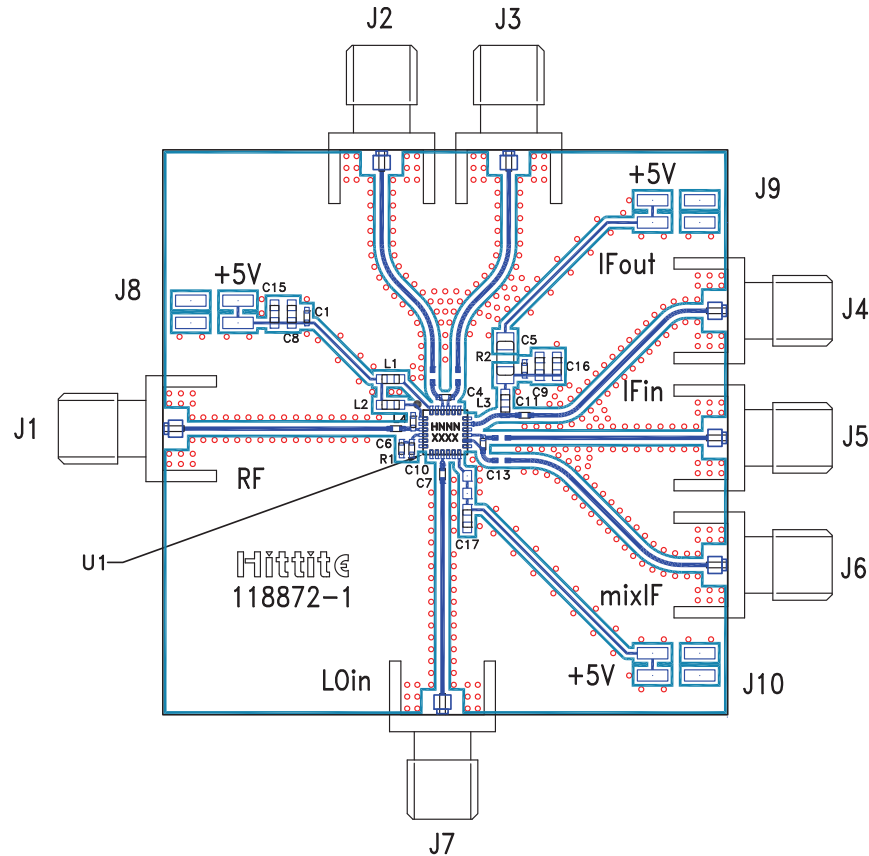
Evaluation PCB

List of Materials for Evaluation PCB 118873 ^[1]

Item	Description
J1 - J7	SMA Connector
J8 - J10	2mm 12 pos Vertical Molex Connector
C1, C4 - C7	100 pF Capacitor, 0402 Pkg.
C8, C9	1000 pF Capacitor, 0603 Pkg.
C10	1000 pF Capacitor, 0402 Pkg.
C11, C13	820 pF Capacitor, 0402 Pkg.
C15	0.47 μ F Capacitor, 0603 Pkg.
C16	1 μ F Capacitor, 0603 Pkg.
C17	10 kpF Capacitor, 0603 Pkg.
R1	1k Ohm Resistor, 0402 Pkg.
R2	1.8 Ohm Resistor, 1206 Pkg.
L1	5.6 nH Inductor, 0603 Pkg.
L2	22 nH Inductor, 0603 Pkg.
L3	110 nH Inductor, 0603 Pkg.
U1	HMC623LP4(E) - Downconverter
PCB ^[2]	118872 Evaluation Board

[1] Reference this number when ordering complete evaluation PCB

[2] Circuit Board Material: Arlon 25RF, FR4

The circuit board used in the final application should use RF circuit design techniques. Signal lines should have 50 Ohm impedance while the package ground leads and exposed paddle should be connected directly to the ground plane similar to that shown. A sufficient number of via holes should be used to connect the top and bottom ground planes. The evaluation circuit board shown is available from Hittite upon request.