

Typical Applications

The HMC659LC5 wideband PA is ideal for:

- Telecom Infrastructure
- Microwave Radio & VSAT
- Military & Space
- Test Instrumentation
- Fiber Optics

Features

- P1dB Output Power: +27.5 dBm
- Gain: 19 dB
- Output IP3: +35 dBm
- Supply Voltage: +8V @ 300 mA
- 50 Ohm Matched Input/Output
- 32 Lead Ceramic 5x5mm SMT Package: 25mm²

Functional Diagram

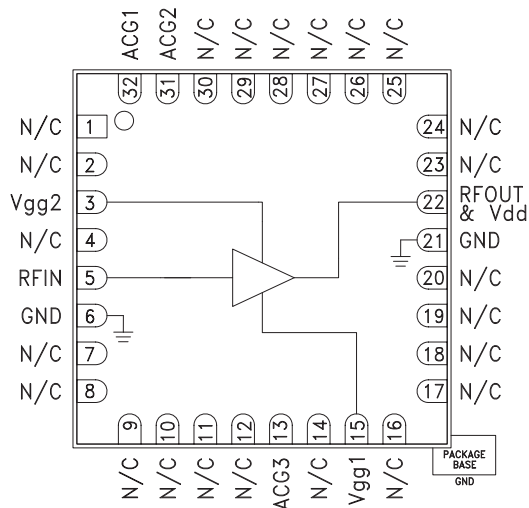

General Description

The HMC659LC5 is a GaAs MMIC PHEMT Distributed Power Amplifier which is housed in a leadless 5x5 mm RoHS compliant ceramic SMT package operating between DC and 15 GHz. The amplifier provides 19 dB of gain, +35 dBm output IP3 and +27.5 dBm of output power at 1 dB gain compression, while requiring 300mA from a +8V supply. Gain flatness is excellent at ± 1.4 dB from DC - 15 GHz making the HMC659LC5 ideal for EW, ECM, Radar and test equipment applications. The HMC659LC5 amplifier I/Os are internally matched to 50 ohms with no external components. The HMC659LC5 is compatible with high volume surface mount manufacturing techniques.

Electrical Specifications, $T_A = +25^\circ\text{C}$, $V_{dd} = +8\text{V}$, $V_{gg2} = +3\text{V}$, $I_{dd} = 300\text{ mA}^*$

Parameter	Min.	Typ.	Max.	Min.	Typ.	Max.	Min.	Typ.	Max.	Units
Frequency Range	DC - 6			6 - 11			11 - 15			GHz
Gain	16	19		15	18		14	17		dB
Gain Flatness		± 0.7			± 0.4			± 0.7		dB
Gain Variation Over Temperature		0.015			0.019			0.022		dB/°C
Input Return Loss		20			18			17		dB
Output Return Loss		19			20			15		dB
Output Power for 1 dB Compression (P1dB)	23.5	26.5		24.5	27.5		23.5	26.5		dBm
Saturated Output Power (P _{sat})		28.0			28.5			27.5		dBm
Output Third Order Intercept (IP3)		35			32			29		dBm
Noise Figure		3.0			2.5			3.5		dB
Supply Current (I _{dd}) (V _{dd} = 8V, V _{gg1} = -0.8V Typ.)		300			300			300		mA

* Adjust V_{gg1} between -2 to 0V to achieve I_{dd}= 300 mA typical.

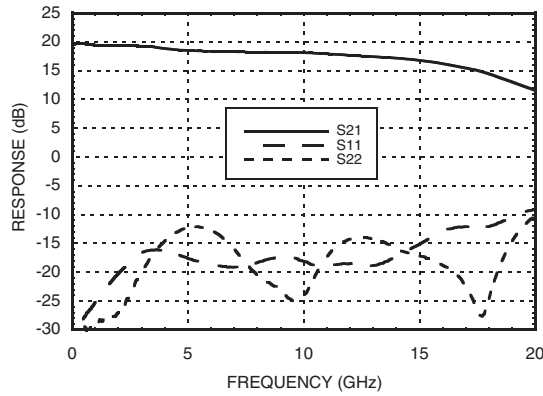
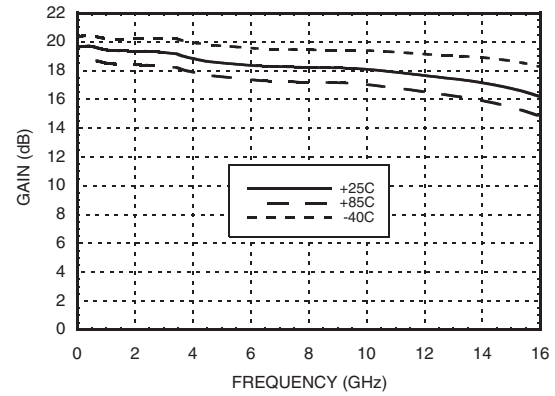
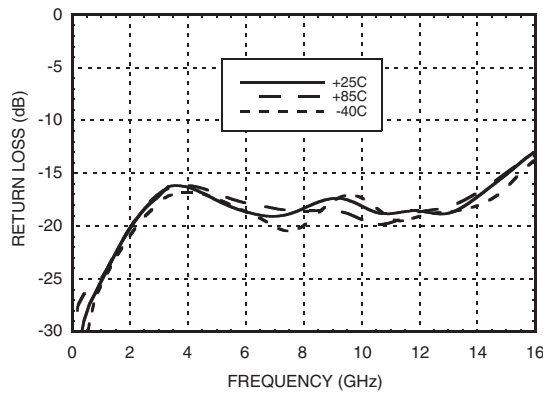
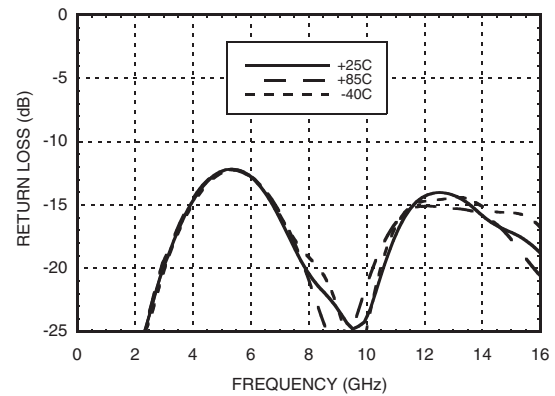
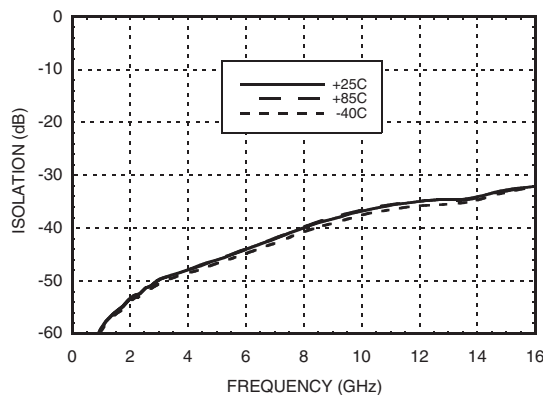
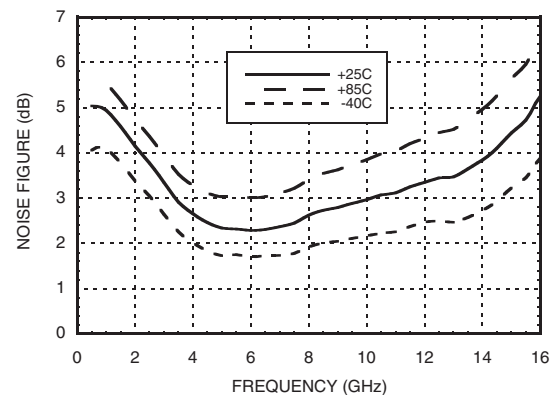
Gain & Return Loss

Gain vs. Temperature

Input Return Loss vs. Temperature

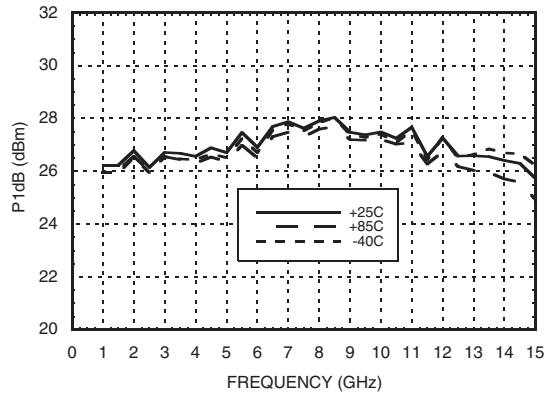
Output Return Loss vs. Temperature

Reverse Isolation vs. Temperature

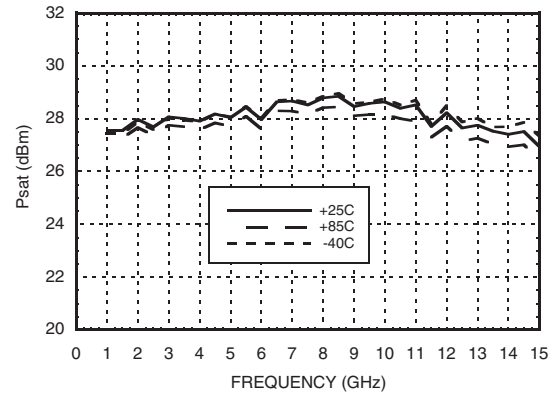
Noise Figure vs. Temperature



Output P1dB vs. Temperature



Psat vs. Temperature



Output IP3 vs. Temperature

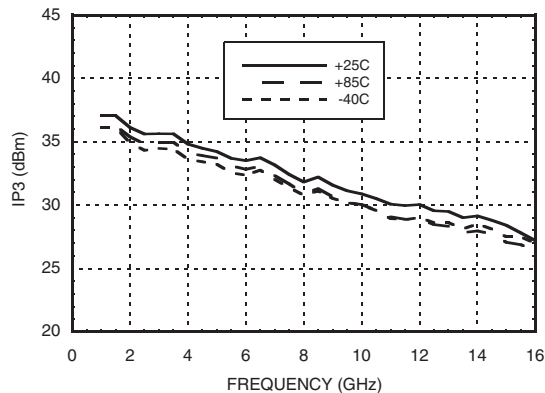

Output IP3 vs. Output Power @ 5GHz

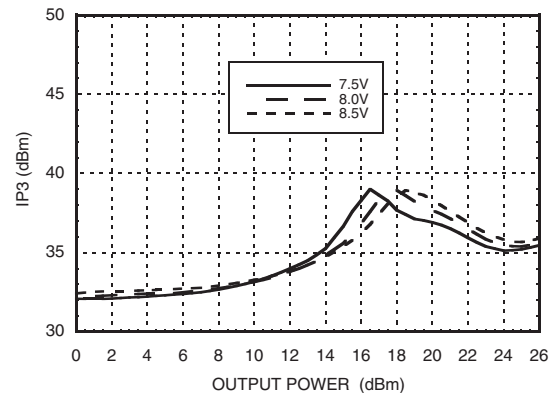

Gain, Power & Output IP3 vs. Supply Voltage @ 7 GHz, Fixed Vgg

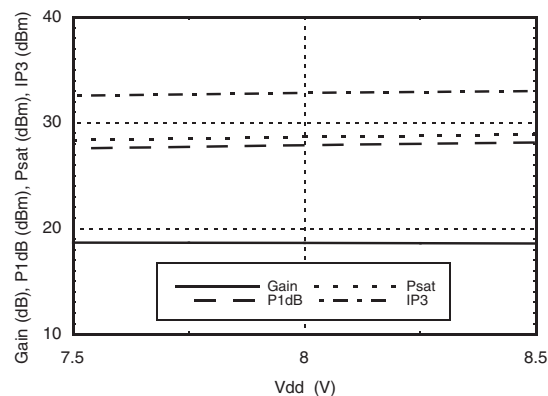

Power Compression @ 2 GHz

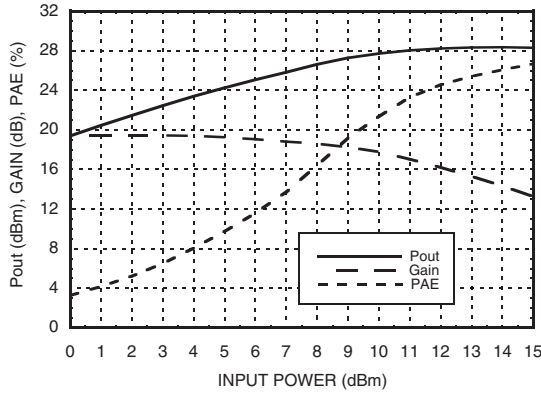

Power Compression @ 7 GHz

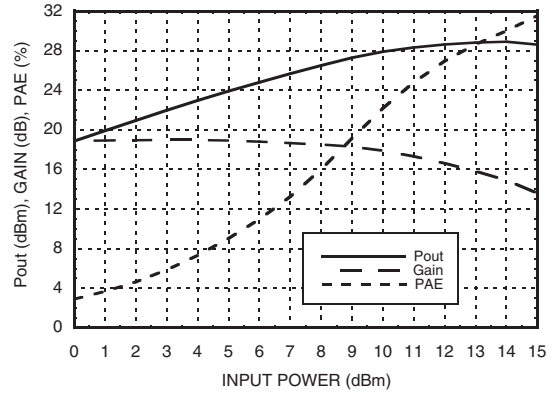

Power Compression @ 15 GHz

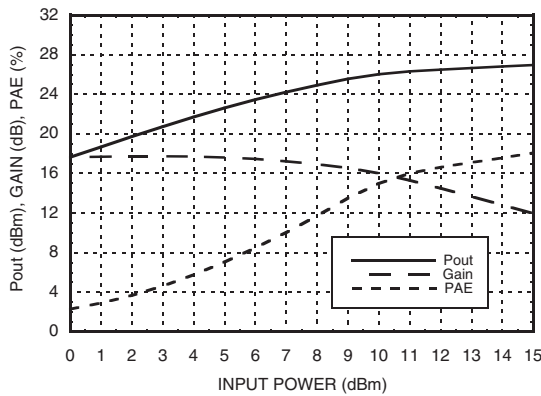

Power Dissipation

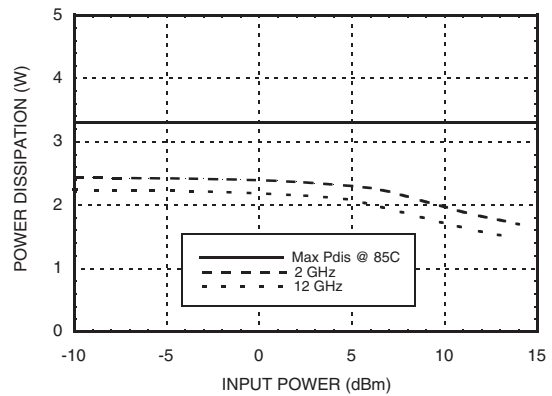

Absolute Maximum Ratings

Drain Bias Voltage (Vdd)	9 Vdc
Gate Bias Voltage (Vgg1)	-2 to 0 Vdc
Gate Bias Voltage (Vgg2)	+2V to +4V
RF Input Power (RFIN)(Vdd = +8 Vdc)	+20 dBm
Channel Temperature	175 °C
Continuous Pdis (T= 85 °C) (derate 37 mW/°C above 85 °C)	3.3 W
Thermal Resistance (channel to ground paddle)	27.3 °C/W
Storage Temperature	-65 to 150 °C
Operating Temperature	-40 to 85 °C

Typical Supply Current vs. Vdd

Vdd (V)	Idd (mA)
7.5	299
8.0	300
8.5	301



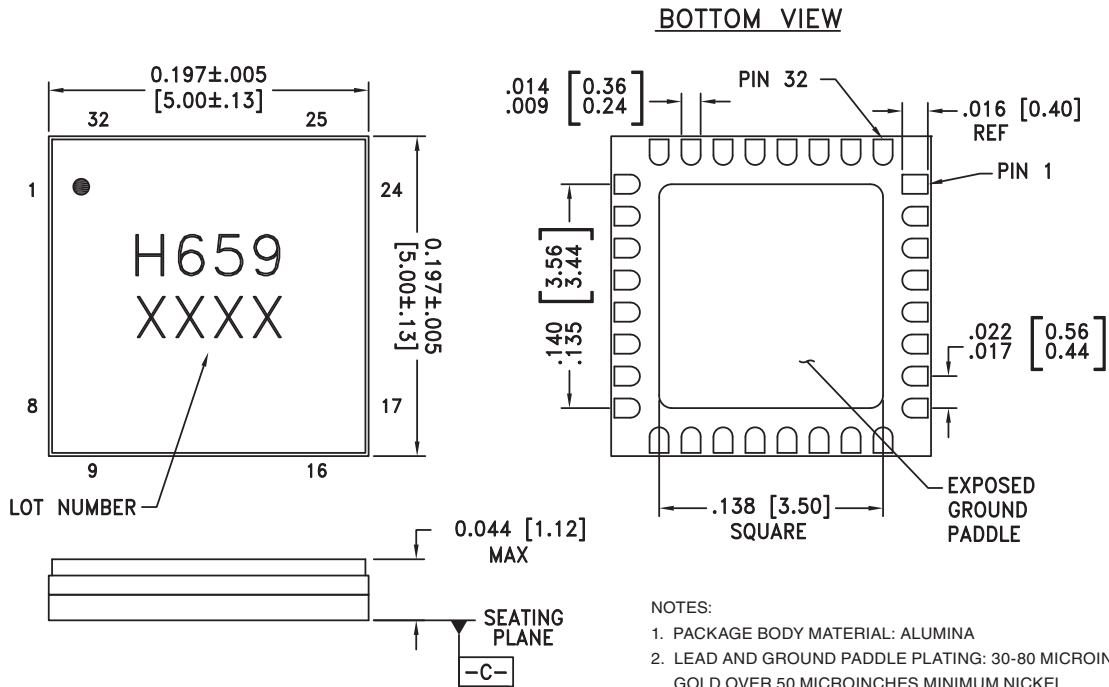

ELECTROSTATIC SENSITIVE DEVICE
OBSERVE HANDLING PRECAUTIONS

Outline Drawing

NOTES:

1. PACKAGE BODY MATERIAL: ALUMINA
2. LEAD AND GROUND PADDLE PLATING: 30-80 MICROINCHES GOLD OVER 50 MICROINCHES MINIMUM NICKEL.
3. DIMENSIONS ARE IN INCHES [MILLIMETERS].
4. LEAD SPACING TOLERANCE IS NON-CUMULATIVE.
5. CHARACTERS TO BE LASER MARKED WITH .018"MIN to .030"MAX HEIGHT REQUIREMENTS. UTILIZE MAXIMUM CHARACTER HEIGHT BASED ON LID DIMENSIONS AND BEST FIT. LOCATE APPROX. AS SHOWN.
6. PACKAGE WARP SHALL NOT EXCEED 0.05mm DATUM -C-
7. ALL GROUND LEADS AND GROUND PADDLE MUST BE SOLDERED TO PCB RF GROUND.

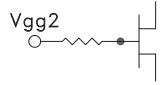
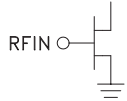
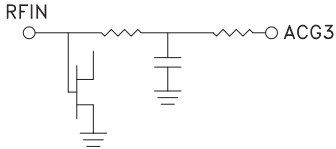
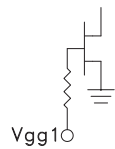
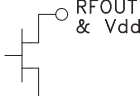
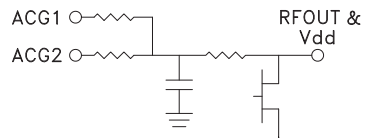

Pin Descriptions

Pin Number	Function	Description	Interface Schematic
1, 2, 4, 7 - 12, 14, 16 - 20, 23 - 30	N/C	No connection. These pins may be connected to RF ground. Performance will not be affected.	
3	Vgg2	Gate Control 2 for amplifier. +3V should be applied to Vgg2 for nominal operation.	
5	RFIN	This pad is DC coupled and matched to 50 Ohms.	
13	ACG3	Low frequency termination. Attach bypass capacitor per application circuit herein.	
15	Vgg1	Gate Control 1 for amplifier.	
22	RFOUT & Vdd	RF output for amplifier. Connect the DC bias (Vdd) network to provide drain current (Idd). See application circuit herein.	
31	ACG2	Low frequency termination. Attach bypass capacitor per application circuit herein.	
32	ACG1		
6, 21 Ground Paddle	GND	Ground paddle must be connected to RF/DC ground.	



Application Circuit

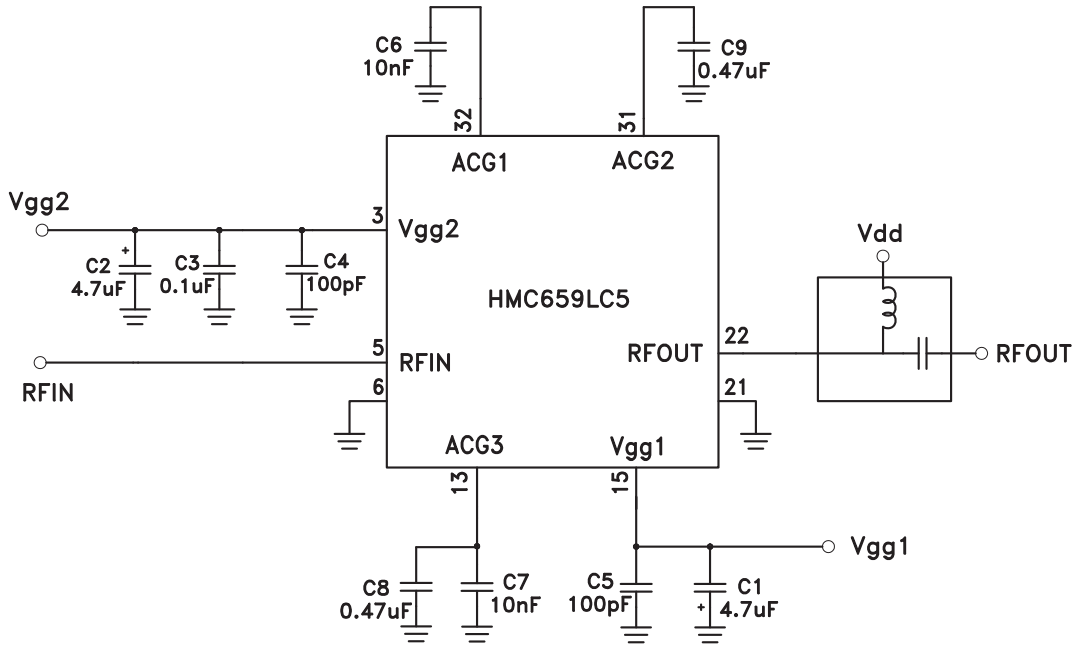

Evaluation PCB

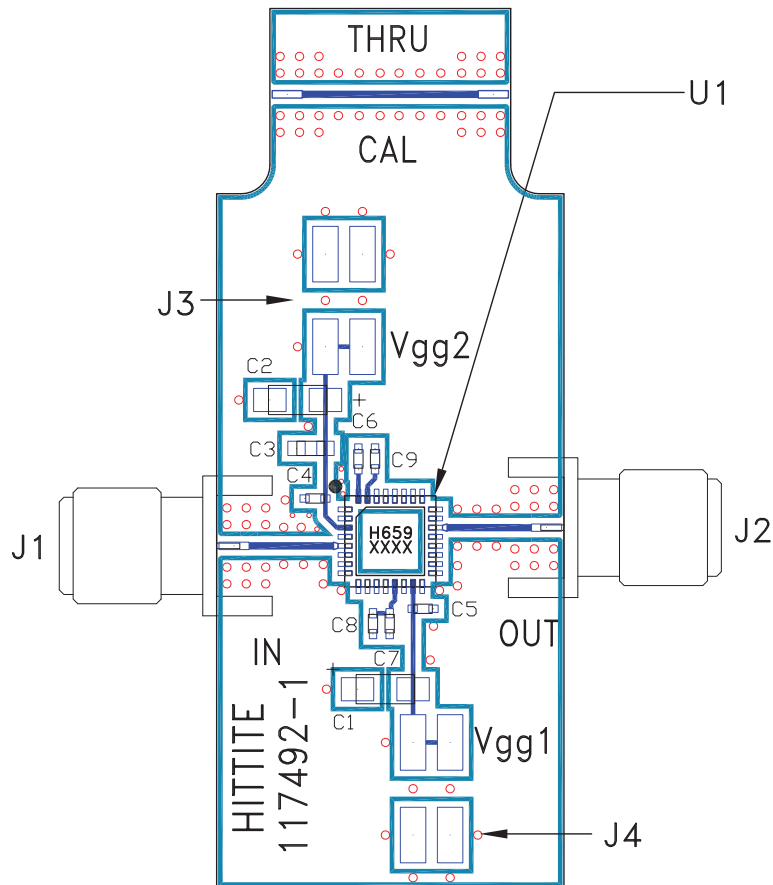

List of Materials for Evaluation PCB 117494 [1]

Item	Description
J1, J2	SMA-SRI-NS
J3, J4	2mm Molex Header
C1, C2	4.7 μ F Capacitor
C3	0.1 μ F Capacitor, 0603 Pkg.
C4, C5	100 pF Capacitor, 0402 Pkg.
C6, C7	10k pF Capacitor, 0402 Pkg.
C8, C9	0.47 μ F Capacitor, 0402 Pkg
U1	HMC659LC5
PCB [2]	117492 Evaluation PCB

[1] Reference this number when ordering complete evaluation PCB

[2] Circuit Board Material: Rogers 4350

The circuit board used in the final application should use RF circuit design techniques. Signal lines should have 50 ohm impedance while the package ground leads and package bottom should be connected directly to the ground plane similar to that shown. A sufficient number of via holes should be used to connect the top and bottom ground planes. The evaluation board should be mounted to an appropriate heat sink. The evaluation circuit board shown is available from Hittite upon request.