

26 GHz, T FLIP-FLOP w/ RESET & PROGRAMMABLE OUTPUT VOLTAGE

Typical Applications

The HMC679LC3C is ideal for:

- Serial Data Transmission up to 26 Gbps
- High Speed Frequency Divider (up to 26 GHz)
- Broadband Test & Measurement
- RF ATE Applications

Features

- Supports Clock Frequencies up to 26 GHz
- Differential or Single-Ended Operation
- Fast Rise and Fall Times: 18 / 17 ps
- Low Power Consumption: 270 mW typ.
- Programmable Differential Output Voltage Swing: 600 - 1100 mVp-p
- Propagation Delay: 95 ps
- Single Supply: -3.3 V
- 16 Lead Ceramic 3 x 3 mm SMT Package: 9 mm²

Functional Diagram

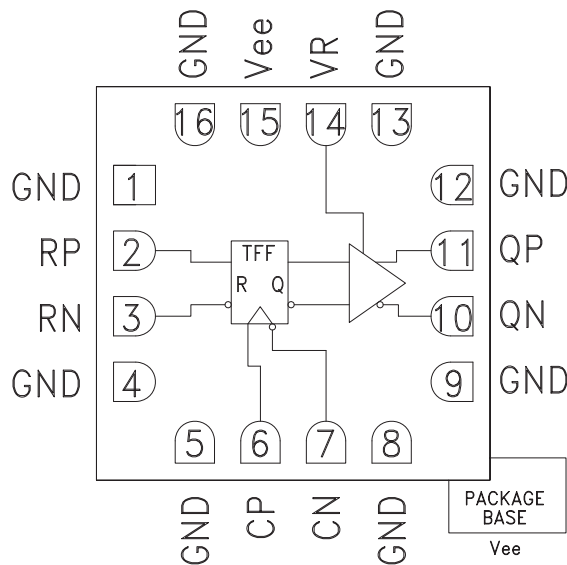

General Description

The HMC679LC3C is a T Flip-Flop w/Reset designed to support clock frequencies as high as 26 GHz. During normal operation, with the reset pin not asserted, the output toggles from its prior state on the positive edge of the clock. This results in a divide-by-two function of the clock input. Asserting the reset pin forces the Q output low regardless of the clock edge state (asynchronous reset assertion). Reversing the clock inputs allows for negative-edge triggered applications.

All differential inputs to the HMC679LC3C are CML and terminated on-chip with 50 Ohms to the positive supply, GND, and may be DC or AC coupled. Outputs can be connected directly to a 50 Ohm ground-terminated system or drive devices with CML logic input. The HMC679LC3C also features an output level control pin, VR, which allows for loss compensation or signal level optimization. The HMC679LC3C operates from a single -3.3 V supply and is available in ROHS-compliant 3x3 mm SMT package.

Electrical Specifications, $T_A = +25\text{ }^\circ\text{C}$, $V_{ee} = -3.3\text{ V}$, $VR = 0\text{ V}$

| Parameter | Conditions | Min. | Typ. | Max | Units |
|--------------------------|----------------------------|------|------|------|-------|
| Power Supply Voltage | | -3.6 | -3.3 | -3.0 | V |
| Power Supply Current | | | 82 | | mA |
| Maximum Clock Rate | | | 26 | | GHz |
| Input Voltage Range | | -1.5 | | 0.5 | V |
| Input Differential Range | | 0.1 | | 2.0 | Vp-p |
| Input Return Loss | Frequency <23 GHz | | 10 | | dB |
| Output Amplitude | Single-Ended, peak-to-peak | | 550 | | mVp-p |
| | Differential, peak-to-peak | | 1100 | | mVp-p |
| Output High Voltage | | | -10 | | mV |
| Output Low Voltage | | | -560 | | mV |



26 GHz, T FLIP-FLOP w/ RESET & PROGRAMMABLE OUTPUT VOLTAGE

Electrical Specifications (continued)

| Parameter | Conditions | Min. | Typ. | Max | Units |
|-----------------------------------|--|------|---------|-----|---------|
| Output Rise / Fall Time | Differential, 20% - 80% | | 18 / 17 | | ps |
| Output Return Loss | Frequency <13 GHz | | 10 | | dB |
| Random Jitter Jr | rms ^[1] | | | 0.2 | ps rms |
| Deterministic Jitter, Jd | peak-to-peak, 2 ¹⁵ -1 PRBS input ^[2] | | 2 | | ps, p-p |
| Propagation Delay Clock to Q, td | | | 95 | | ps |
| Propagation Delay Reset to Q, tdr | | | 125 | | ps |
| VR Pin Current | VR = 0.0 V | | 2 | | mA |
| VR Pin Current | VR = +0.4 V | | | 3.5 | mA |

[1] Upper limit of random jitter, J_R, determined by measuring and integrating output phase noise with a sinusoidal input at 5, 10, and 13.5 GHz over temperature.

[2] Deterministic jitter calculated by simultaneously measuring the jitter of a 200 mV, 12.5 GHz, 2¹⁵-1 PRBS input, and a single-ended output

DC Current vs. Supply Voltage ^{[1][2]}

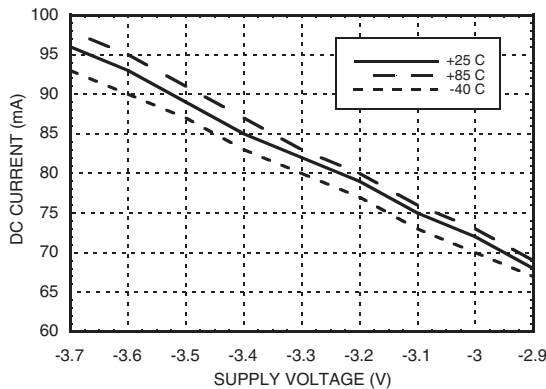

Output Differential Voltage vs. Supply Voltage ^{[1][2]}

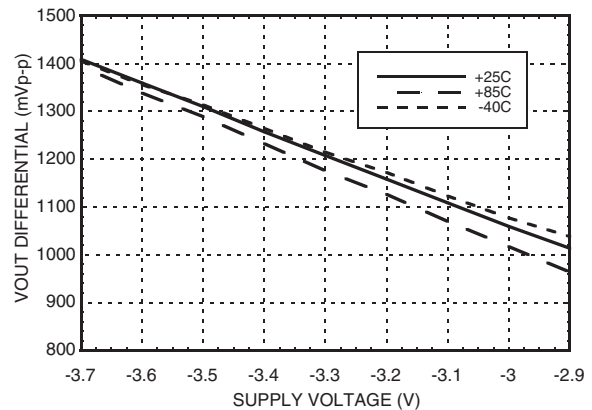

Rise / Fall Time vs. Supply Voltage ^{[1][3]}

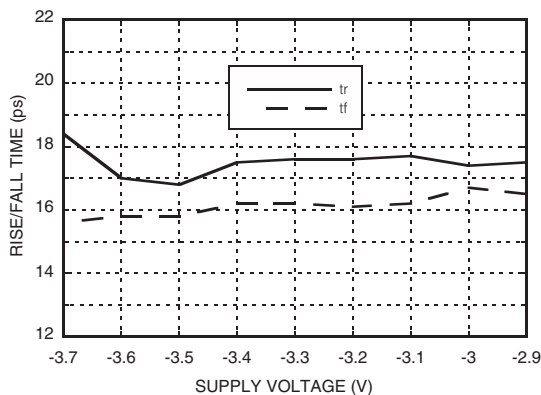

Output Differential Voltage vs. Input Frequency ^[1]

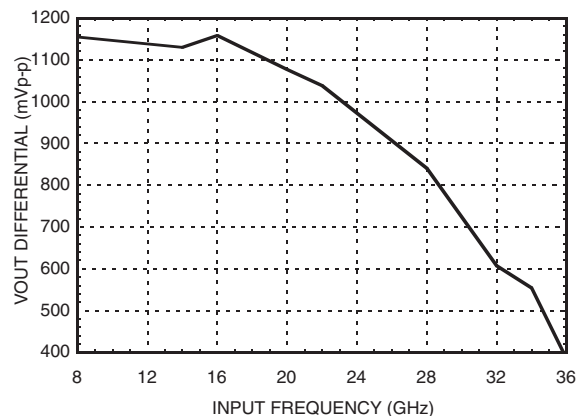

[1] VR = 0.0 V

[2] Frequency = 13 GHz

[3] Frequency = 24 GHz



Output Differential Voltage vs. VR [2]

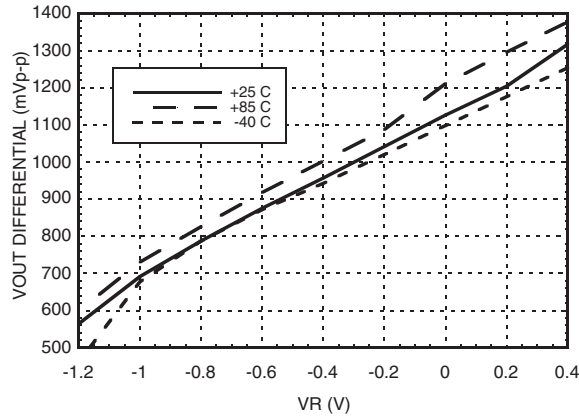

Rise / Fall Time vs. VR [3]

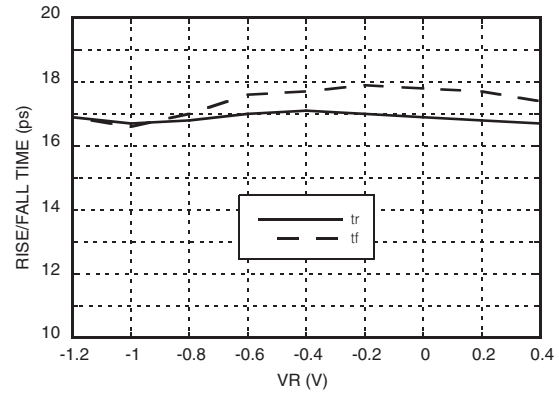

Input Return Loss vs. Frequency [4]

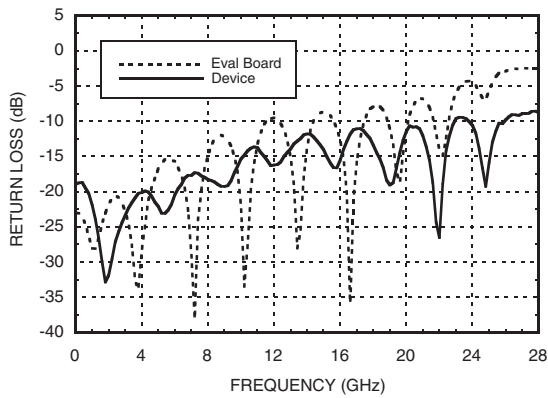

Output Return Loss vs. Frequency [4]

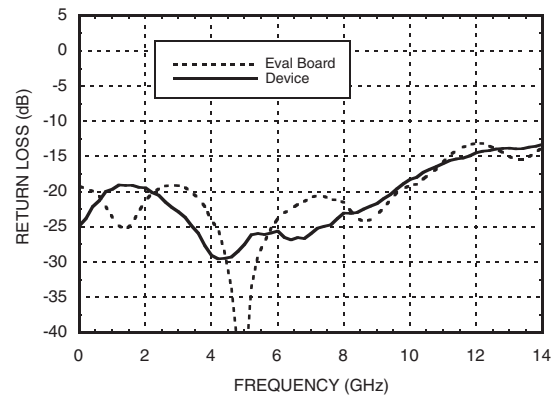

Reset Input Return Loss vs. Frequency [4]

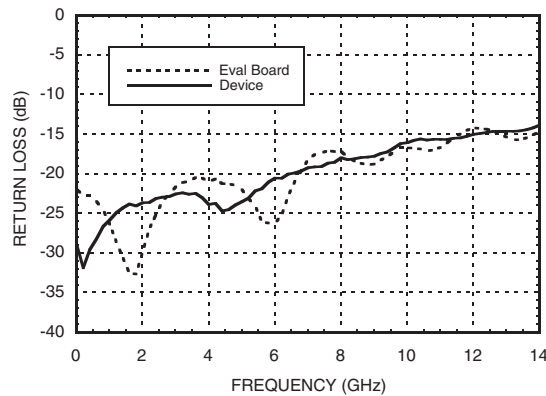

[1] VR = 0.0 V

[2] Frequency = 13 GHz

[3] Frequency = 24 GHz

[4] Device measured on evaluation board with single-ended, time-domain gating



26 GHz, T FLIP-FLOP w/ RESET & PROGRAMMABLE OUTPUT VOLTAGE

Output Waveform

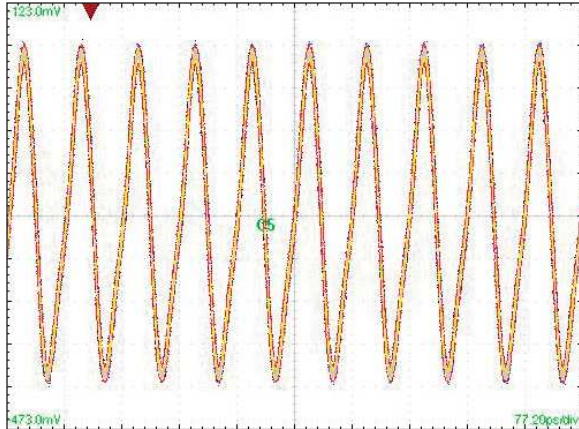

[1] Test Conditions:
Waveform generated with a CW signal source input at 26 GHz.
Diagram data presented on a Tektronix CSA 8000.

Timing Diagram

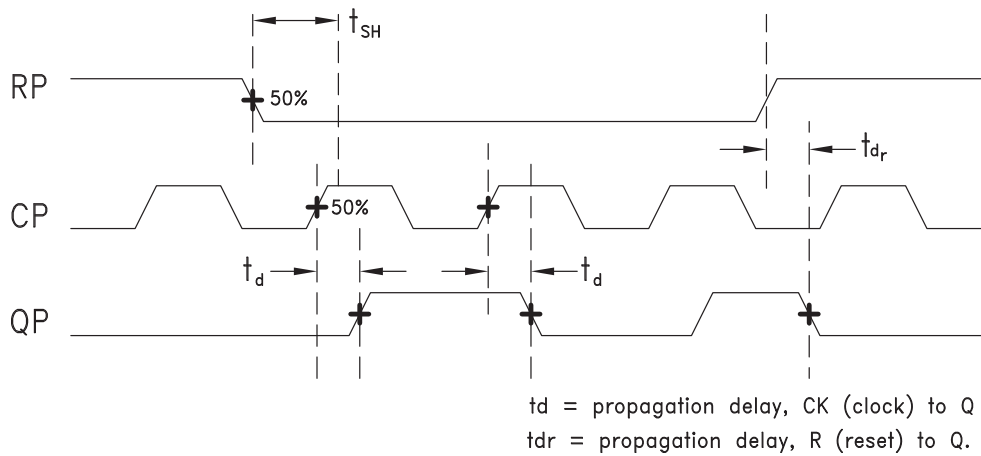

Absolute Maximum Ratings

| | |
|---|-------------------|
| Power Supply Voltage (Vee) | -3.75 V to +0.5 V |
| Input Signals | -2 V to +0.5 V |
| Output Signals | -1.5 V to +1 V |
| Continuous P _{diss} (T = 85 °C) (derate 17 mW/°C above 85 °C) | 0.68 W |
| Thermal Resistance (R _{th(j-p)}) Worst Case Junction to Package Paddle | 59 °C/W |
| Maximum Junction Temperature | 125 °C |
| Storage Temperature | -65 °C to +150 °C |
| Operating Temperature | -40 °C to +85 °C |
| ESD Sensitivity (HBM) | Class 1C |



ELECTROSTATIC SENSITIVE DEVICE
OBSERVE HANDLING PRECAUTIONS

Outline Drawing

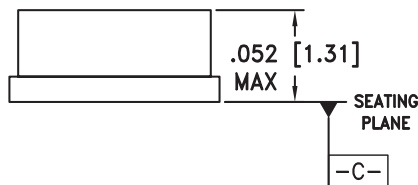
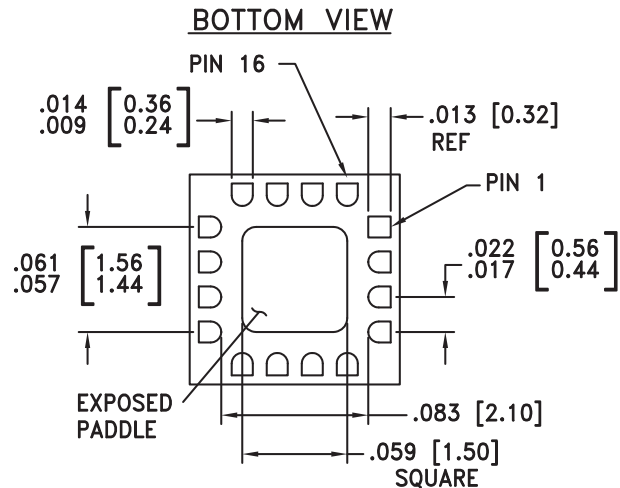
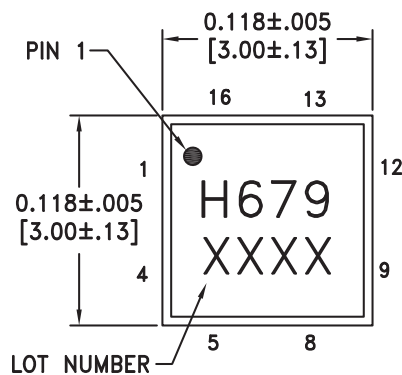



NOTES:

1. PACKAGE BODY MATERIAL: ALUMINA
2. LEAD AND GROUND PADDLE PLATING:
30-80 MICROINCHES GOLD OVER 50 MICROINCHES MINIMUM NICKEL.
3. DIMENSIONS ARE IN INCHES [MILLIMETERS].
4. LEAD SPACING TOLERANCE IS NON-CUMULATIVE.
5. PACKAGE WARP SHALL NOT EXCEED 0.05 mm DATUM -C-
6. ALL GROUND LEADS MUST BE SOLDERED TO PCB RF GROUND.
7. PADDLE MUST BE SOLDERED TO Vee.

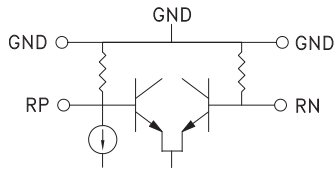
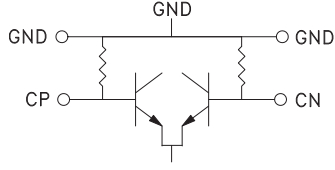
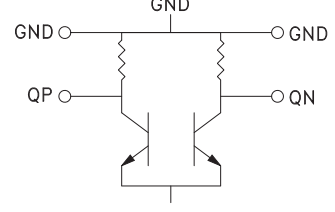

26 GHz, T FLIP-FLOP w/ RESET & PROGRAMMABLE OUTPUT VOLTAGE

Pin Descriptions

| Pin Number | Function | Description | Interface Schematic |
|-------------------|----------|---|---|
| 1, 4, 5, 8, 9, 12 | GND | Signal Grounds |  |
| 2, 3 | RP,RN | Differential Reset Inputs: Current Mode Logic (CML) referenced to positive supply. |  |
| 6, 7 | CP,CN | Differential Clock Inputs: Current Mode Logic (CML) referenced to positive supply. |  |
| 10, 11 | QN, QP | Differential Clock Outputs: Current Mode Logic (CML) referenced to positive supply. |  |
| 13, 16 | GND | Supply Ground |  |
| 14 | VR | Output level control. Output level may be increased or decreased by applying a voltage to VR per "Output Differential vs. VR" plot. |  |
| 15, Package Base | Vee | This pin and the exposed paddle must be connected to the negative voltage supply. | |

Evaluation PCB

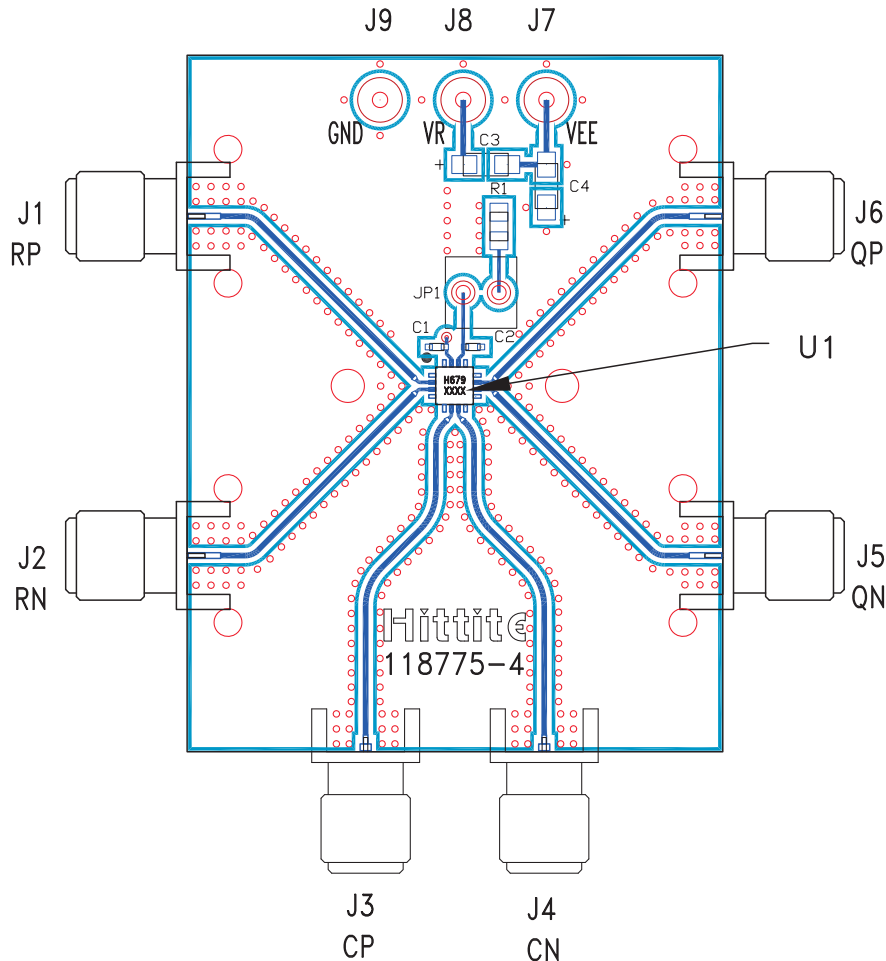

List of Materials for Evaluation PCB 123585 [1]

| Item | Description |
|----------------|----------------------------------|
| J1, J2, J5, J6 | PCB Mount SMA RF Connectors |
| J3, J4 | PCB Mount 2.92mm RF Connectors |
| J7 - J9 | DC Pin |
| JP1 | 0.1" Header with Shorting Jumper |
| C1, C2 | 100 pF Capacitor, 0402 Pkg. |
| C3, C4 | 4.7 μF Capacitor, Tantalum |
| R1 | 10 Ohm Resistor, 0603 Pkg. |
| U1 | HMC679LC3C |
| PCB [2] | 118775 Evaluation Board |

[1] Reference this number when ordering complete evaluation PCB

[2] Circuit Board Material: Arlon 25FR or Rogers 4350

The circuit board used in the application should use RF circuit design techniques. Signal lines should have 50 Ohm impedance while the package ground leads should be connected directly to the ground plane similar to that shown. The exposed packaged base should be connected to Vee. A sufficient number of via holes should be used to connect the top and bottom ground planes. The evaluation circuit board shown is available from Hittite upon request. Install jumper on JP1 to short VR to GND for normal operation.

Application Circuit

