



13 Gbps, FAST RISE TIME AND/NAND/OR/NOR GATE, w/ PROGRAMMABLE OUTPUT VOLTAGE & POSITIVE SUPPLY

Typical Applications

The HMC746LC3C is ideal for:

- RF ATE Applications
- Broadband Test & Measurement
- Serial Data Transmission up to 13 Gbps
- Digital Logic Systems up to 13 GHz
- NRZ-to-RZ Conversion

Features

- Supports High Data Rates: up to 13 Gbps
- Differential & Single-Ended Operation
- Fast Rise and Fall Times: 22 / 21 ps
- Low Power Consumption: 230 mW typ.
- Programmable Differential Output Voltage Swing: 600 - 1100 mV
- Propagation Delay: 95 ps
- Single Supply: +3.3V
- 16 Lead Ceramic 3x3mm SMT Package: 9mm²

Functional Diagram

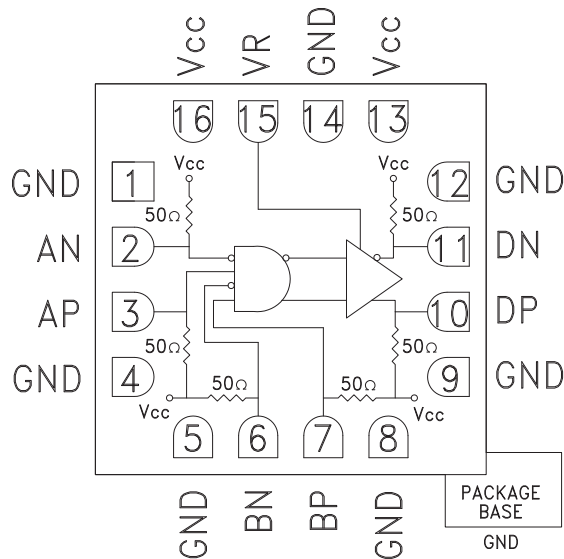

General Description

The HMC746LC3C is an AND/NAND/OR/NOR function designed to support data transmission rates of up to 13 Gbps, and clock frequencies as high as 13 GHz. The HMC746LC3C may be easily configured to provide any of the following logic functions: AND, NAND, OR and NOR. The HMC746LC3C also features an output level control pin, VR, which allows for loss compensation or for signal level optimization.

All input and output signals to the HMC746LC3C are terminated with 50 Ohms to Vcc on-chip, and may be either AC or DC coupled. Inputs and outputs can be connected directly to a 50 Ohm to Vcc terminated system, while DC blocking capacitors may be used if the terminating system is 50 Ohms to ground. The HMC746LC3C operates from a single +3.3V DC supply, and is available in a ceramic RoHS compliant 3x3 mm SMT package.

Electrical Specifications, T_A = +25 °C, V_{cc} = +3.3V

Parameter	Conditions	Min.	Typ.	Max	Units
Power Supply Voltage		3.0	3.3	3.6	V
Power Supply Current			70		mA
Maximum Data Rate			13		Gbps
Maximum Clock Rate			13		GHz
Input High Voltage		2.8		3.8	V
Input Low Voltage		2.1		3.3	V
Input Return Loss	Frequency <13 GHz		10		dB
Output Amplitude	Single-Ended, peak-to-peak		550		mVp-p
	Differential, peak-to-peak		1100		mVp-p
Output High Voltage			3.25		V

For price, delivery and to place orders: Hittite Microwave Corporation, 20 Alpha Road, Chelmsford, MA 01824

Phone: 978-250-3343 Fax: 978-250-3373 Order On-line at www.hittite.com

Application Support: Phone: 978-250-3343 or apps@hittite.com



13 Gbps, FAST RISE TIME AND/NAND/OR/NOR GATE, w/ PROGRAMMABLE OUTPUT VOLTAGE & POSITIVE SUPPLY

Electrical Specifications, (continued)

Parameter	Conditions	Min.	Typ.	Max	Units
Output Low Voltage			2		V
Output Rise / Fall Time	Differential, 20% - 80%		22 / 21		ps
Output Return Loss	Frequency <13 GHz		10		dB
Small Signal Gain			27		dB
Random Jitter Jr	rms			0.2	ps rms
Deterministic Jitter, Jd	peak-to-peak, 2 ¹⁵ -1 PRBS input [1]		2		ps, p-p
Propagation Delay, td			95		ps

[1] Deterministic jitter calculated by simultaneously measuring the jitter of a 300 mV, 13 GHz, 2¹⁵-1 PRBS input, and a single-ended output

DC Current vs. Supply Voltage [1] [2]

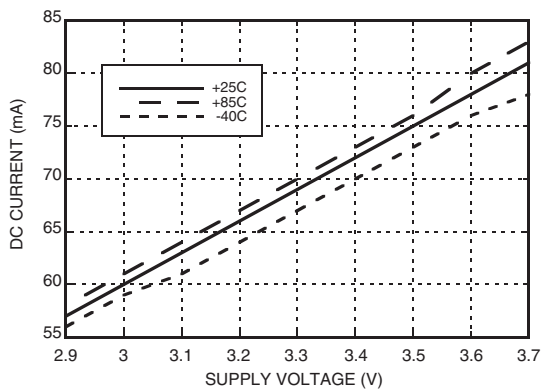

Output Differential vs. Supply Voltage [1] [2]

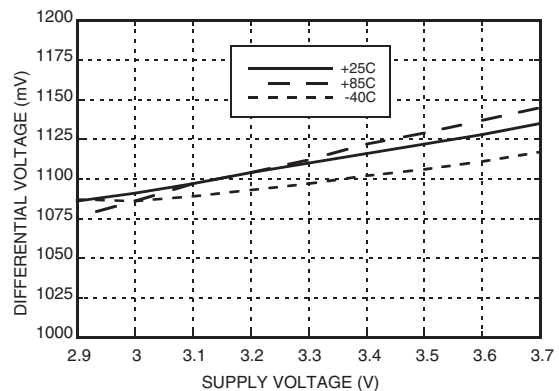

Rise / Fall Time vs. Supply Voltage [2]

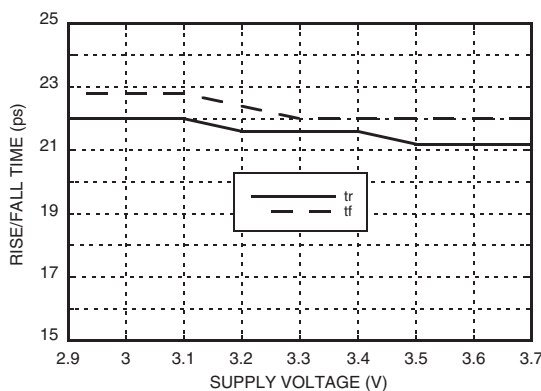

Output Differential vs. Frequency [1]

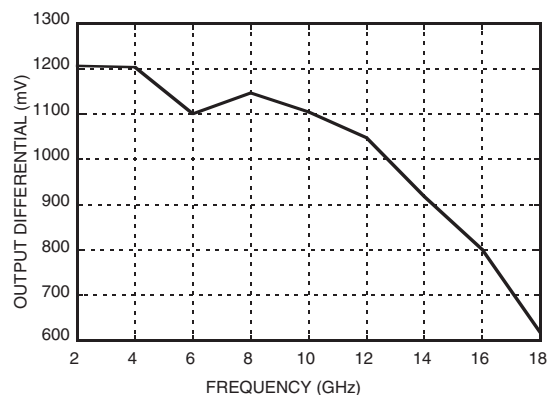

[1] VR = +3.3V

[2] Frequency = 13 GHz

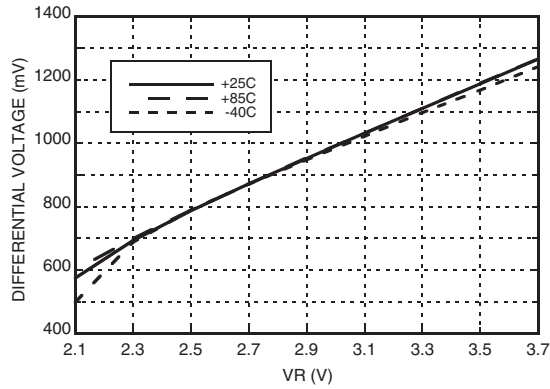
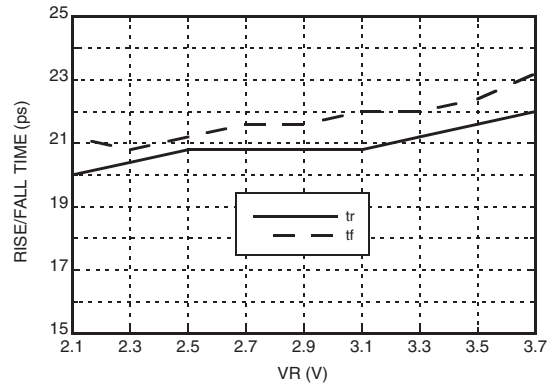
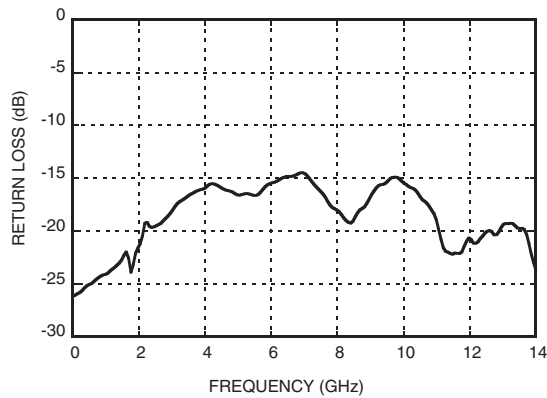
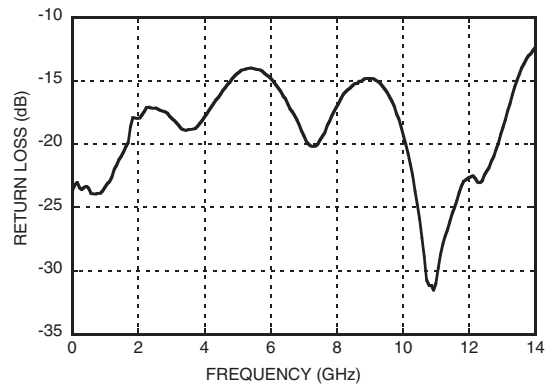

**13 Gbps, FAST RISE TIME AND/NAND/OR/NOR GATE,
w/ PROGRAMMABLE OUTPUT VOLTAGE & POSITIVE SUPPLY**

Output Differential vs. VR [2]

Rise / Fall Time vs. VR [2]

Input Return Loss vs. Frequency

Output Return Loss vs. Frequency

[1] VR = +3.3V

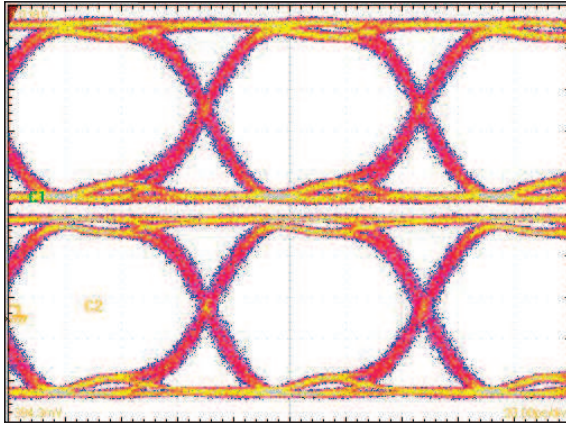
[2] Frequency = 13 GHz



**13 Gbps, FAST RISE TIME AND/NAND/OR/NOR GATE,
w/ PROGRAMMABLE OUTPUT VOLTAGE & POSITIVE SUPPLY**

Eye Diagram

[1] Test Conditions:
 Pattern generated with an Agilent N4903A Serial BERT.
 Eye Diagram presented on a Tektronix CSA 8000.
 Device input = 13 Gbps PN code.
 Device is AC coupled to scope.

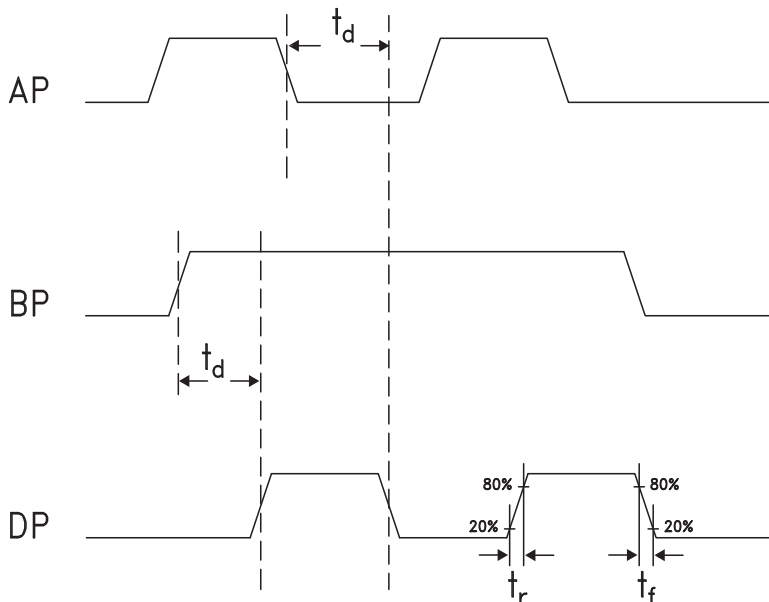
Timing Diagram

Truth Table

Input		Outputs
A	B	D
L	L	L
L	H	L
H	L	L
H	H	H

Notes:
 A = AP - AN
 B = BP - BN
 D = DP - DN

H - Positive voltage level
 L - Negative voltage level



13 Gbps, FAST RISE TIME AND/NAND/OR/NOR GATE, w/ PROGRAMMABLE OUTPUT VOLTAGE & POSITIVE SUPPLY

Absolute Maximum Ratings

Power Supply Voltage (Vcc)	-0.5V to +3.7V
Input Signals	Vcc - 2V to Vcc + 0.5V
Output Signals	+1V to +3.7V
Storage Temperature	-65°C to +150°C
Operating Temperature	-40°C to +85°C



ELECTROSTATIC SENSITIVE DEVICE
OBSERVE HANDLING PRECAUTIONS

3

HIGH SPEED LOGIC - SMT

Outline Drawing

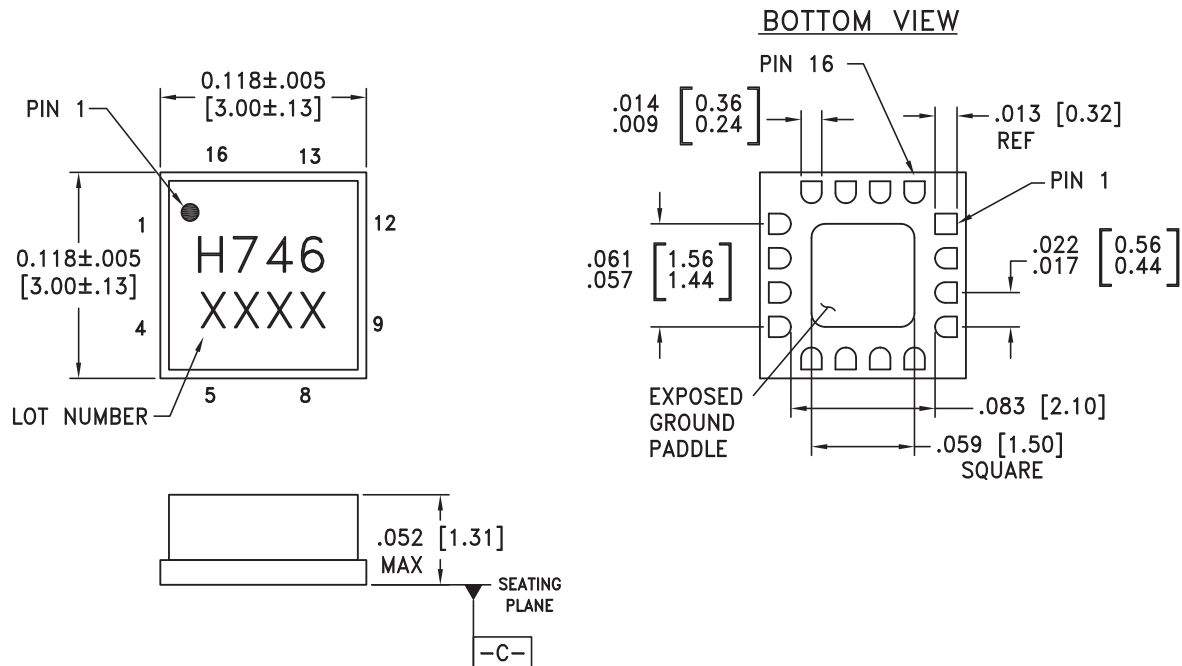



NOTES:

1. PACKAGE BODY MATERIAL: ALUMINA
2. LEAD AND GROUND PADDLE PLATING:
30-80 MICROINCHES GOLD OVER 50 MICROINCHES MINIMUM NICKEL.
3. DIMENSIONS ARE IN INCHES [MILLIMETERS].
4. LEAD SPACING TOLERANCE IS NON-CUMULATIVE.
5. PACKAGE WARP SHALL NOT EXCEED 0.05mm DATUM -C-
6. ALL GROUND LEADS MUST BE SOLDERED TO PCB RF GROUND.
7. PADDLE MUST BE SOLDERED TO GND.

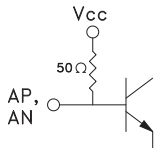
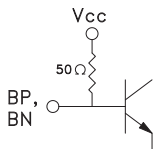
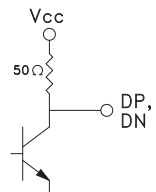

**13 Gbps, FAST RISE TIME AND/NAND/OR/NOR GATE,
w/ PROGRAMMABLE OUTPUT VOLTAGE & POSITIVE SUPPLY**

Pin Descriptions

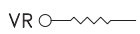
Pin Number	Function	Description	Interface Schematic
1, 4, 5, 8, 9, 12	GND	Signal Grounds	
2, 3	AN, AP	Clock / Data Input A	
6, 7	BN, BP	Clock / Data Input B	
10, 11	DP, DN	Clock / Data Output	
13, 16	Vcc	Positive Supply	
14, Package Base	GND	Supply Ground	
15	VR	Output level control. Output level may be adjusted by applying a voltage to VR per "Output Differential vs. VR" plot.	



13 Gbps, FAST RISE TIME AND/NAND/OR/NOR GATE, w/ PROGRAMMABLE OUTPUT VOLTAGE & POSITIVE SUPPLY

Evaluation PCB

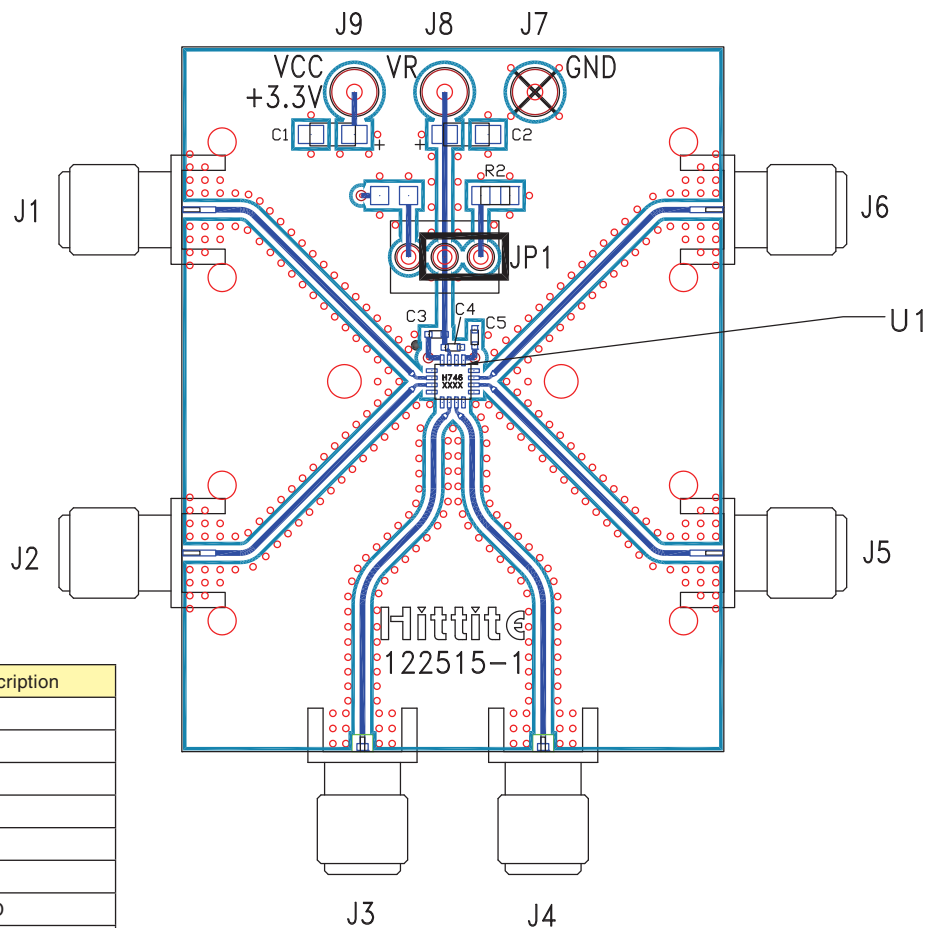

Item	Description
J1	AN
J2	AP
J3	BN
J4	BP
J5	DP
J6	DN
J7	GND
J8	VR
J9	Vcc

List of Materials for Evaluation PCB 122517 [1]

Item	Description
J1 - J6	PCB Mount SMA RF Connectors
J7 - J9	DC Pin
JP1	Shorting Jumper
C1, C2	4.7 μ F Capacitor, Tantalum
C3 - C5	100 pF Capacitor, 0402 Pkg.
R2	10 Ohm Resistor, 0603 Pkg.
U1	HMC746LC3C High Speed Logic, AND / NAND / OR / NOR
PCB [2]	122515 Evaluation Board

[1] Reference this number when ordering complete evaluation PCB

[2] Circuit Board Material: Arlon 25FR

The circuit board used in the application should use RF circuit design techniques. Signal lines should have 50 Ohm impedance while the package ground leads should be connected directly to the ground plane similar to that shown. The exposed package base should be connected to GND. A sufficient number of via holes should be used to connect the top and bottom ground planes. The evaluation circuit board shown is available from Hittite upon request.



13 Gbps, FAST RISE TIME AND/NAND/OR/NOR GATE, w/ PROGRAMMABLE OUTPUT VOLTAGE & POSITIVE SUPPLY

Application Circuit

