



### Typical Applications

The HMC784MS8GE is ideal for:

- Cellular / 4G Infrastructure
- WiMAX, WiBro & Fixed Wireless
- Automotive Telematics
- Mobile Radio
- Test Equipment

### Features

- Input P1dB: +40 dBm @ Vdd = +8V
- High Third Order Intercept: +62 dBm
- Positive Control: +3 to +8 V
- Low Insertion Loss: 0.4 dB
- MSOP8G Package: 14.8 mm<sup>2</sup>

### Functional Diagram

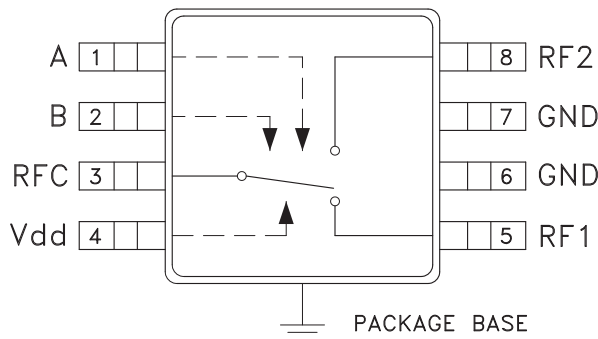

### General Description

The HMC784MS8GE is a high power SPDT switch in an 8-lead MSOP8G package for use in transmit-receive applications which require very low distortion at high input signal power levels. The device can control signals from DC to 4 GHz. The design provides exceptional intermodulation performance; > +60 dBm third order intercept at +5V bias. RF1 and RF2 are reflective shorts when "OFF". On-chip circuitry allows single positive supply operation from +3 Vdc to +8 Vdc at very low DC current with control inputs compatible with CMOS and most TTL logic families.

### Electrical Specifications,

$T_A = +25^\circ C$ ,  $V_{ctl} = 0/V_{dd}$ ,  $V_{dd} = +5V$  (Unless Otherwise Stated), 50 Ohm System

Parameter	Frequency	Min.	Typ.	Max.	Units
Insertion Loss	DC - 1.0 GHz		0.4	0.6	dB
	DC - 2.0 GHz		0.6	0.8	dB
	DC - 2.5 GHz		0.8	1.1	dB
	DC - 3.0 GHz		0.9	1.3	dB
	DC - 4.0 GHz		1.3	2.0	dB
Isolation	DC - 4.0 GHz	26	30		dB
Return Loss (On State)	DC - 1.0 GHz		35		dB
	DC - 2.0 GHz		30		dB
	DC - 3.0 GHz		20		dB
	DC - 4.0 GHz		10		dB
Input Power for 0.1dB Compression	Vdd = +3V		32		dBm
	Vdd = +5V	0.1 - 4.0 GHz	37		dBm
	Vdd = +8V		38		dBm
Input Power for 1dB Compression	Vdd = +3V		32		dBm
	Vdd = +5V	0.1 - 4.0 GHz	35	38	dBm
	Vdd = +8V		38	41	dBm
Input Third Order Intercept (Two-tone input power = +30 dBm each tone)	0.02 - 0.1 GHz		42		dBm
	0.1 - 2.0 GHz		62		dBm
	0.1 - 3.0 GHz		61		dBm
	0.1 - 4.0 GHz		60		dBm
Switching Characteristics	tRISE, tFALL (10/90% RF)	DC - 4.0 GHz	15		ns
	tON, tOFF (50% CTL to 10/90% RF)		40		ns

For price, delivery, and to place orders, please contact Hittite Microwave Corporation:  
20 Alpha Road, Chelmsford, MA 01824 Phone: 978-250-3343 Fax: 978-250-3373  
Order On-line at [www.hittite.com](http://www.hittite.com)

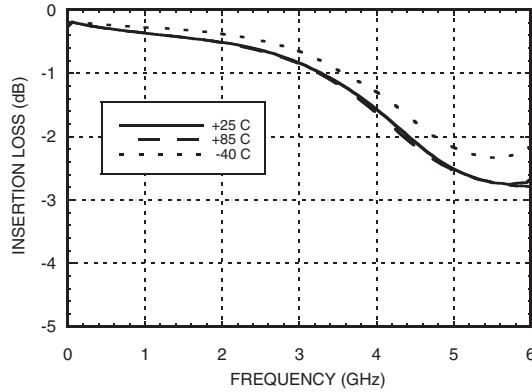
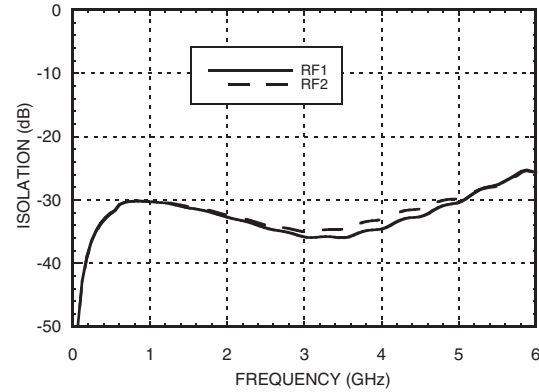
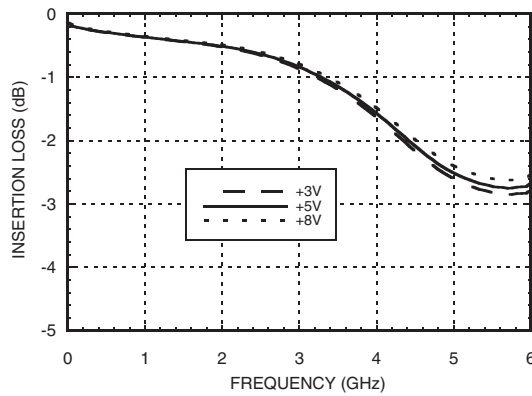
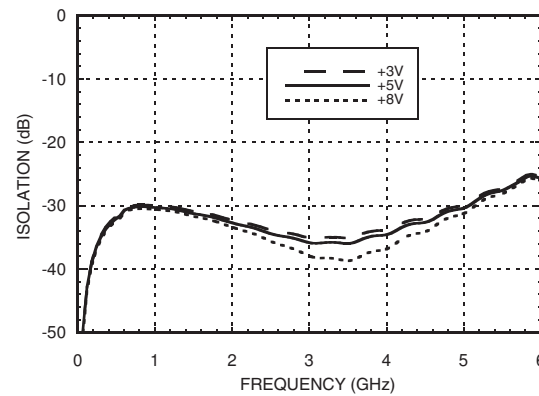
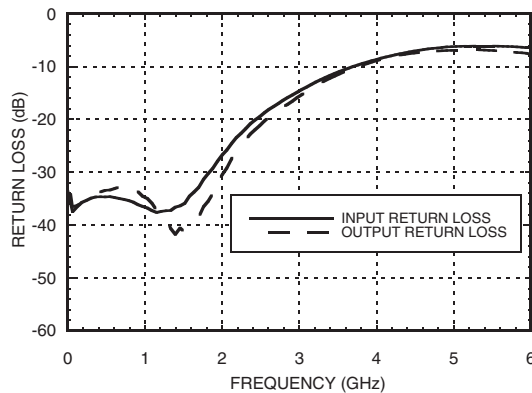
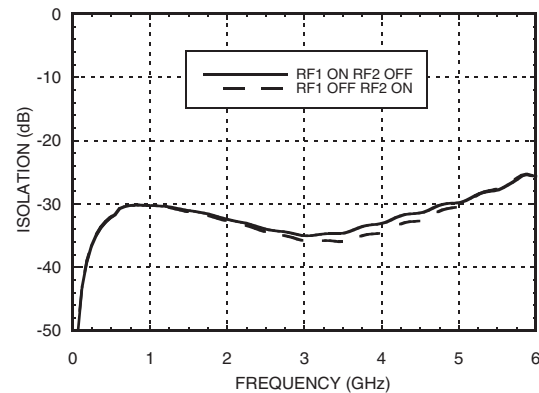
**Insertion Loss vs. Temperature**

**Isolation**

**Insertion Loss vs. Vdd**

**Isolation vs. Vdd**

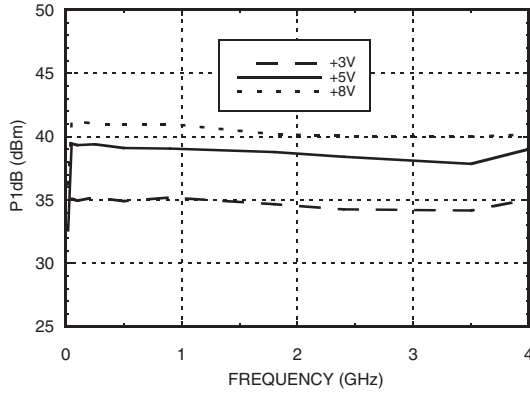
**Return Loss**

**RF1 to RF2 Isolation**



## GaAs MMIC 10 WATT T/R SWITCH DC - 4 GHz

**Input P1dB vs. Vdd**



**Input P0.1dB vs. Vdd**

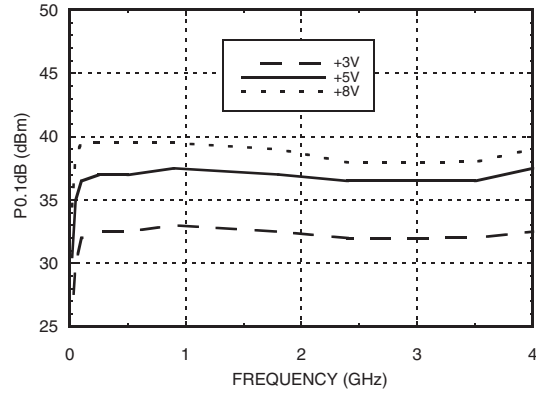

**Input P1dB vs. Temperature @ Vdd = +5V**

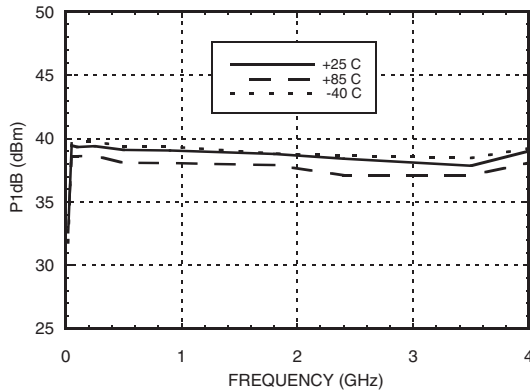

**Input IP3 vs. Tone Power @ Vdd = +3V**

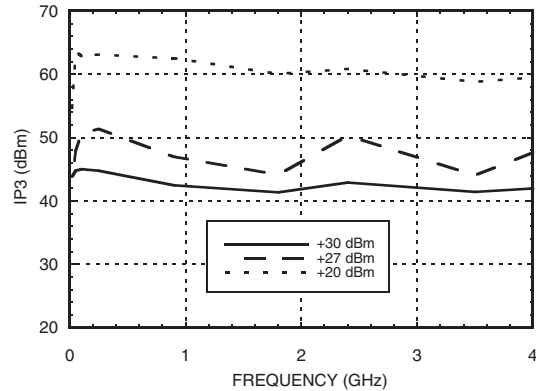

**Input IP3 vs. Tone Power @ Vdd = +5V**

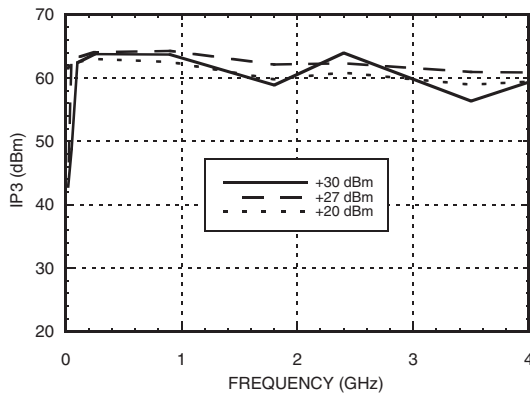

**Input IP3 vs. Tone Power @ Vdd = +8V**

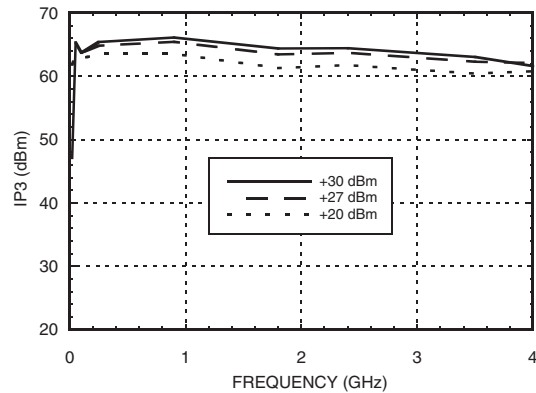



## GaAs MMIC 10 WATT T/R SWITCH DC - 4 GHz

**Input IP3 vs. Temperature**  
27 dBm Tones, Vdd = +3V

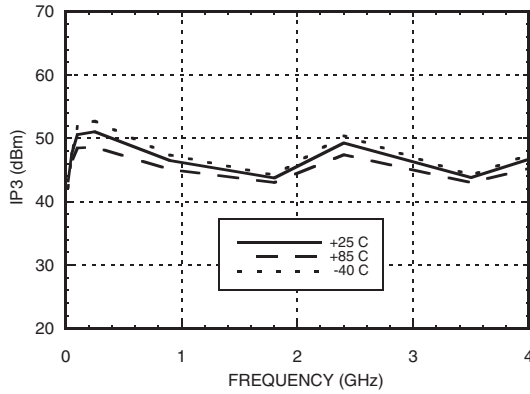

**Input IP3 vs. Temperature**  
27 dBm Tones, Vdd = +5V

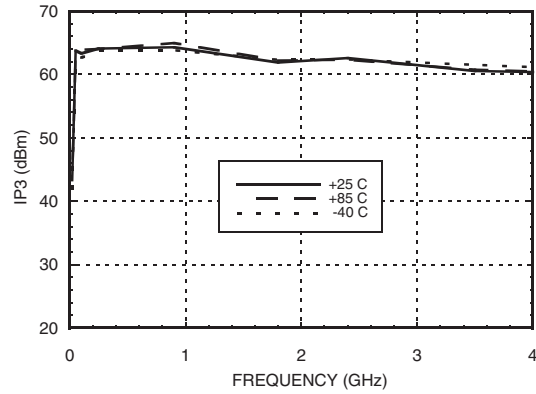

**Input IP3 vs. Temperature**  
27 dBm Tones, Vdd = +8V

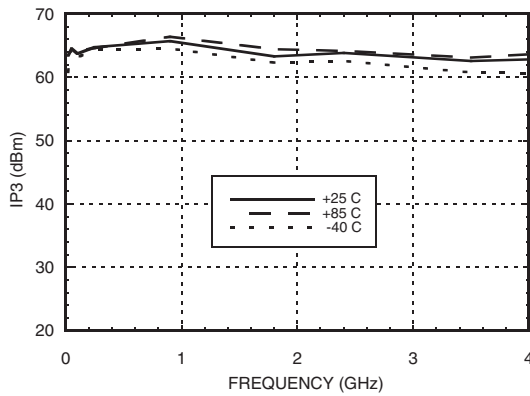

**Input P1dB vs. Vdd**

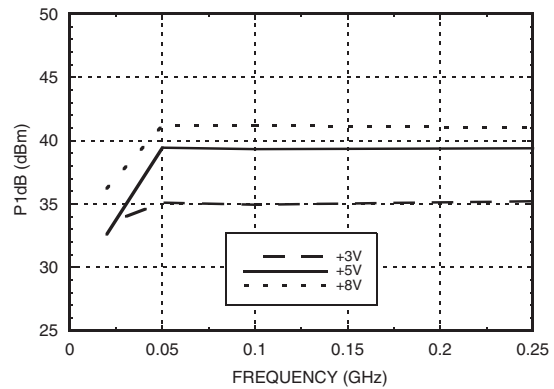

**Input P0.1dB vs. Vdd**

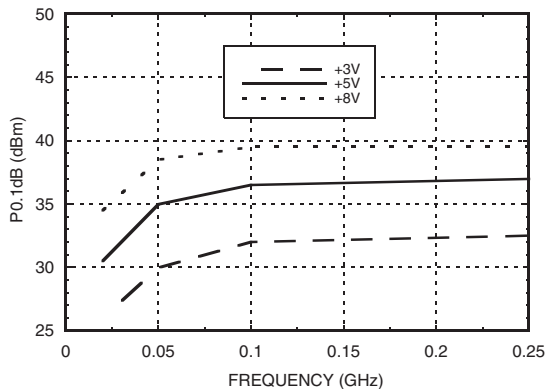

**Input IP3 vs. Tone Power @ Vdd = +5V**

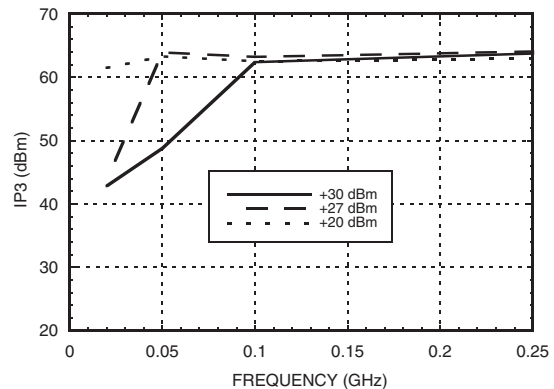



## GaAs MMIC 10 WATT T/R SWITCH DC - 4 GHz

### Bias Voltage & Current

Vdd (V)	Typical Idd (µA)
+3	0.5
+5	2
+8	20

### Control Voltages & Currents

State	Vdd = +3V (µA)	Vdd = +5V (µA)	Vdd = +8V (µA)
Low (0 to +0.2V)	0.5	2	20
High (Vdd ±0.2V)	0.1	0.1	0.1

### Truth Table

Control Input (Vctl)		Signal Path State	
A	B	RFC to RF1	RFC to RF2
High	Low	Off	On
Low	High	On	Off

### Absolute Maximum Ratings

RF Input Power (Vdd = +8V, 50 Ohm source & load impedances)	+39 dBm (T = +85 °C)
Supply Voltage Range (Vdd) (Vctl = 0V)	-0.2 to +9V
Control Voltage Range (A & B)	-0.2 to Vdd +0.5V
Channel Temperature	150 °C
Continuous P <sub>diss</sub> (T = 85 °C) (derate 25 mW/°C above 85 °C)	1.217 W
Thermal Resistance (Channel to ground paddle)	53.4 °C/W
Storage Temperature	-65 to +150 °C
Operating Temperature	-40 to +85 °C
ESD Rating	Class 1A HBM

Note: DC blocking capacitors are required at ports RFC, RF1 and RF2. Their value will determine the lowest transmission frequency.



ELECTROSTATIC SENSITIVE DEVICE  
OBSERVE HANDLING PRECAUTIONS

### Outline Drawing

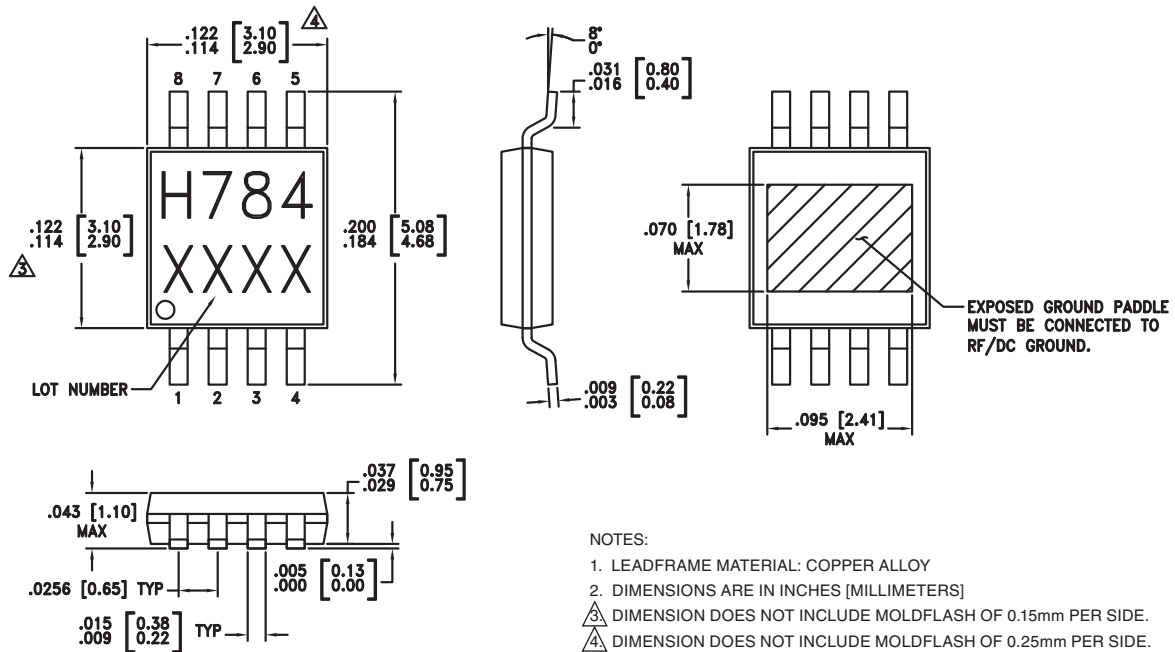

NOTES:

1. LEADFRAME MATERIAL: COPPER ALLOY
2. DIMENSIONS ARE IN INCHES [MILLIMETERS]
- ⚠ DIMENSION DOES NOT INCLUDE MOLDFLASH OF 0.15mm PER SIDE.
- ⚠ DIMENSION DOES NOT INCLUDE MOLDFLASH OF 0.25mm PER SIDE.
5. ALL GROUND LEADS AND GROUND PADDLE MUST BE SOLDERED TO PCB RF GROUND.



### Package Information

Part Number	Package Body Material	Lead Finish	MSL Rating	Package Marking <sup>[1]</sup>
HMC784MS8GE	RoHS-compliant Low Stress Injection Molded Plastic	100% matte Sn	MSL1 <sup>[2]</sup>	H784 XXXX

[1] 4-Digit lot number XXXX

[2] Max peak reflow temperature of 260 °C

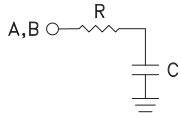
### Pin Descriptions

Pin Number	Function	Description	Interface Schematic
1	A	See truth table and control voltage table.	
2	B	See truth table and control voltage table.	
3, 5, 8	RFC, RF1, RF2	This pin is DC coupled and matched to 50 Ohms. Blocking capacitors are required.	
4	Vdd	Supply Voltage	
6, 7	GND	Package bottom must also be connected to PCB RF ground.	

### Typical Application Circuit

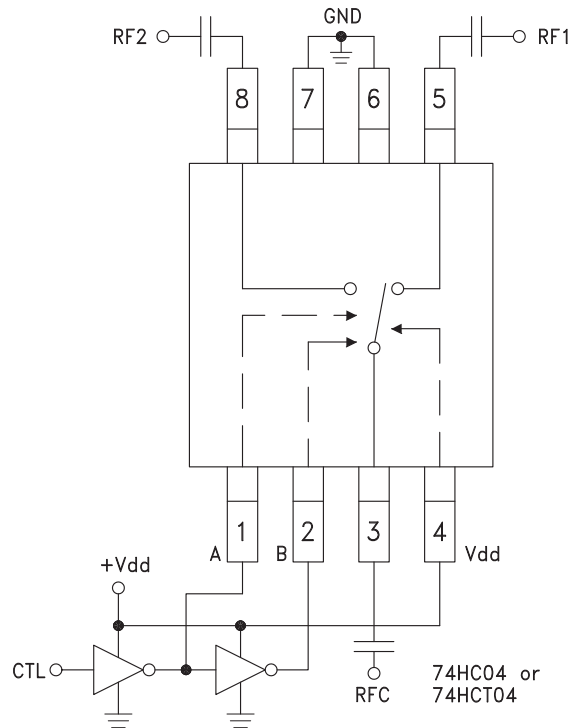

Notes:

1. Set logic gate and switch Vdd = +3V to +8V and use HCT series logic to provide a TTL driver interface.
2. Control inputs A/B can be driven directly with CMOS logic (HC) with Vdd of +3 to +8 Volts applied to the CMOS logic gates and to pin 4 of the RF switch.
3. DC Blocking capacitors are required for each RF port as shown. Capacitor value determines lowest frequency of operation.
4. Highest RF signal power capability is achieved with V set to +8V. The switch will operate properly (but at lower RF power capability) at bias voltages down to +3V.

**Evaluation Circuit Board**

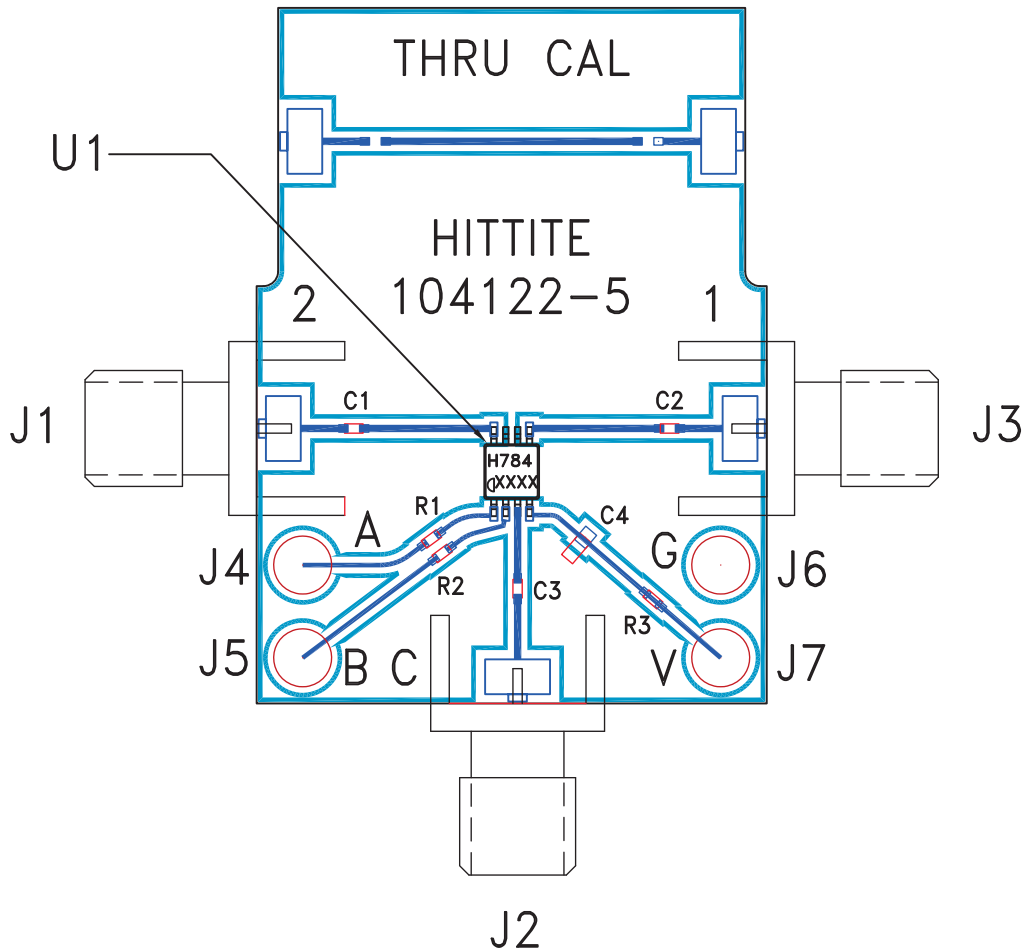

**List of Materials for Evaluation PCB 104124 [1]**

Item	Description
J1 - J3	PCB Mount SMA RF Connector
J4 - J7	DC Pin
C1 - C3	100 pF capacitor, 0402 Pkg.
C4	10 KpF capacitor, 0603 Pkg.
R1 - R3	100 Ohm Resistor, 0402 Pkg.
U1	HMC784MS8GE T/R Switch
PCB [2]	104122 Evaluation PCB

[1] Reference this number when ordering complete evaluation PCB

[2] Circuit Board Material: Rogers 4350

The circuit board used in the final application should be generated with proper RF circuit design techniques. Signal lines at the RF port should have 50 ohm impedance and the package ground leads and package bottom should be connected directly to the ground plane similar to that shown above. The evaluation circuit board shown above is available from Hittite Microwave Corporation upon request.