

### Typical Applications

The HMC844LC4B is ideal for:

- RF ATE Applications
- Broadband Test & Measurement
- Serial Data Transmission up to 45 Gbps
- Digital Logic Systems up to 25 GHz

### Features

- Supports High Data Rates: up to 45 Gbps
- Differential & Single-Ended Operation
- Fast Rise and Fall Times: 11 / 10 ps
- Low Power Consumption: 510 mW
- Programmable Differential Output Voltage Swing: 200 - 850 mVp-p
- Single Supply: -3.3V
- 24 Lead 4x4 mm SMT Package: 16 mm<sup>2</sup>

### Functional Diagram

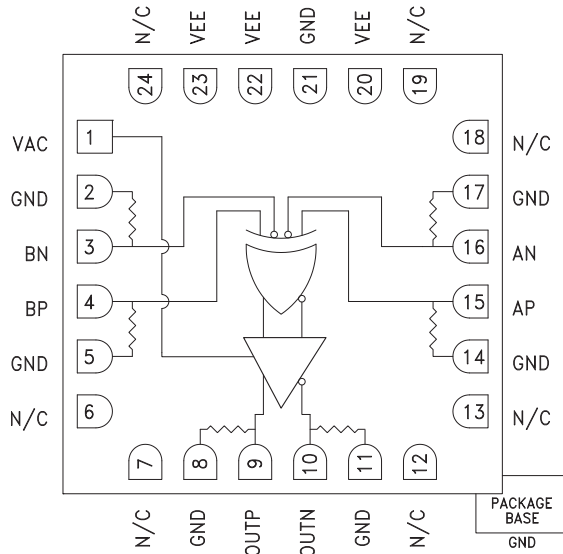

### General Description

The HMC844LC4B is an XOR/XNOR function designed to support data transmission rates of up to 45 Gbps, and clock frequencies as high as 25 GHz. The HMC844LC4B may be easily configured to provide either XOR or XNOR logic functions. The HMC844LC4B also features an output level control pin, VAC, which allows for loss compensation or for signal level optimization.

All input signals to the HMC844LC4B are terminated with 50 Ohms-to-ground on-chip, and may be either AC or DC coupled. The differential outputs of the HMC844LC4B may be either AC or DC coupled. Outputs can be connected directly to a 50 Ohms-to-ground terminated system, while DC blocking capacitors should be used if the terminating system is 50 Ohms to a non-ground DC voltage. The HMC844LC4B operates from a single -3.3V DC supply, and is available in a ceramic RoHS compliant 4x4 mm SMT package.

### Electrical Specifications, $T_A = +25^\circ\text{C}$ , $V_{ee} = -3.3\text{V}$

Parameter	Conditions	Min.	Typ.	Max	Units
Power Supply Voltage	$\pm 5\%$ Tolerance	-3.47	-3.3	-3.13	V
Power Supply Current	VAC = -0.3V	140	155	170	mA
Output Amplitude Control Voltage (VAC)		-1.7	-0.3	-0.1	V
Maximum Data Rate		45			Gbps
Maximum Clock Rate		25			GHz
Input Amplitude	Single-ended, peak-to-peak	100		300	mVp-p
	Differential, peak-to-peak	100		1000	
Input High Voltage		-0.5		0.5	V
Input Low Voltage		-1		0	V
Output Amplitude	Differential, peak-to-peak @ 40 Gbps	200		850	mVp-p

### Electrical Specifications, (continued)

Parameter	Conditions	Min.	Typ.	Max	Units
Output High Voltage		VAC = -0.3	-10		mV
Output Low Voltage		VAC = -0.3	-430		mV
Input Return Loss	Frequency < 25 GHz		8		dB
Output Return Loss	Frequency < 25 GHz		8		dB
Deterministic Jitter, Jd [1]			3		ps, pp
Additive Random Jitter Jr [2]			0.2		ps rms
Rise Time, tr [1]	VAC = -0.3V		11		ps
Fall Time, tf [1]	VAC = -0.3V		10		ps
Propagation Delay, td	@ 40 Gbps		90		ps

[1] A Input: 40 Gbps PRBS 2<sup>23</sup>-1 pattern, 200 mVp-p single-ended, B Input: 40 Gbps 10101... pattern, 200 mVp-p single-ended

[2] Random jitter is measured with 40 Gbps 10101... pattern

#### DC Current vs. Supply Voltage [1] [2]

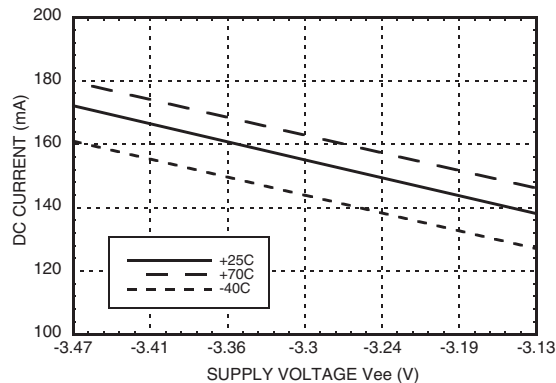

#### Differential Output Swing vs. Supply Voltage [1] [2]

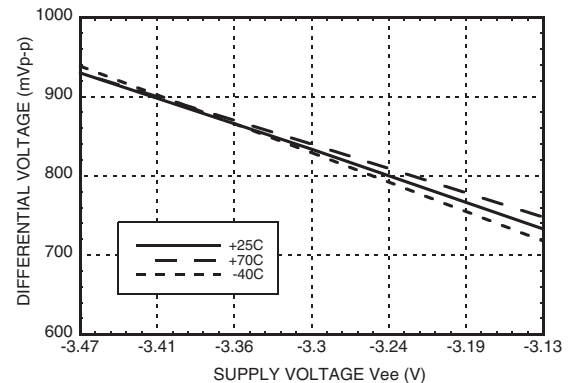

#### DC Current vs. VAC [2]

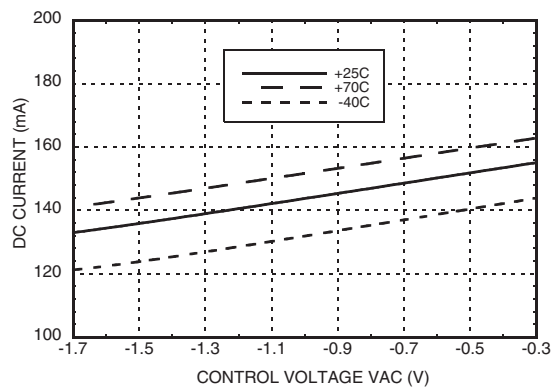

#### Differential Output Swing vs. VAC [2]

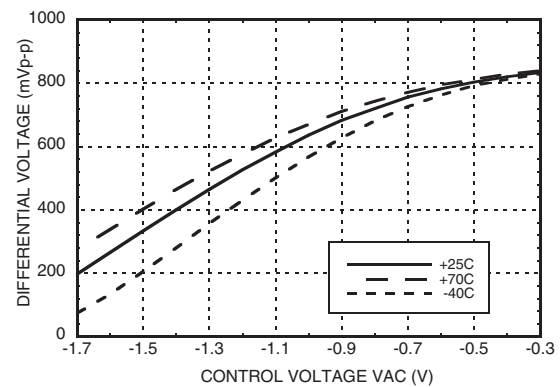

[1] VAC = -0.3V

[2] Input data rate: 40 Gbps PRBS 2<sup>23</sup>-1 pattern



**Rise Time vs. Supply Voltage [1][2][3]**

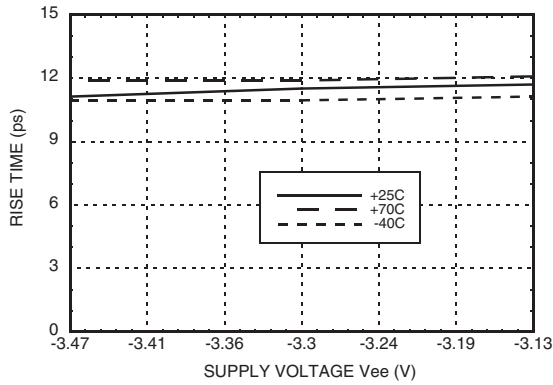

**Fall Time vs. Supply Voltage [1][2][3]**

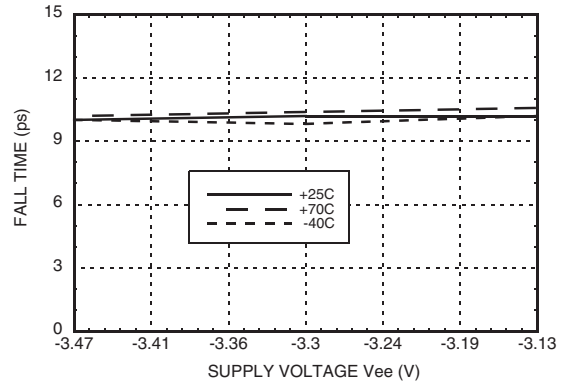

**Rise / Fall Time vs. VAC [1][2][3]**

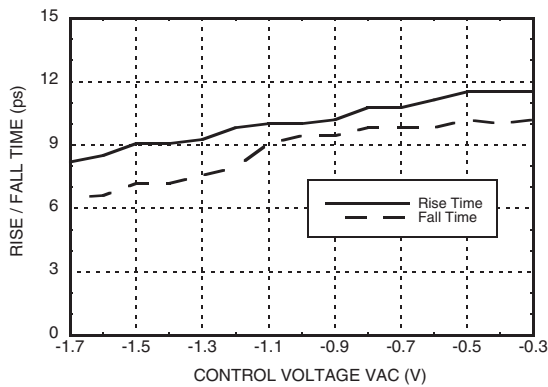

**Peak-to-Peak Jitter vs. Supply Voltage [1][2][3][4]**

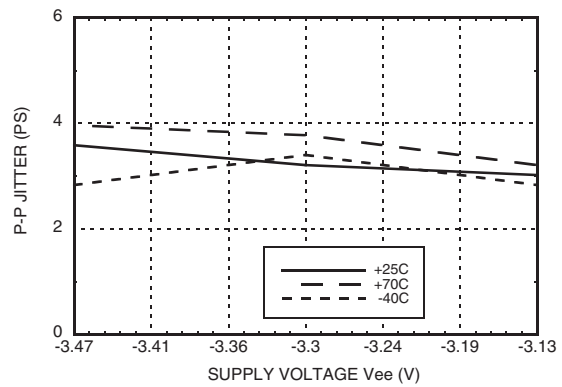

**Input Return Loss vs. Frequency [1][5]**

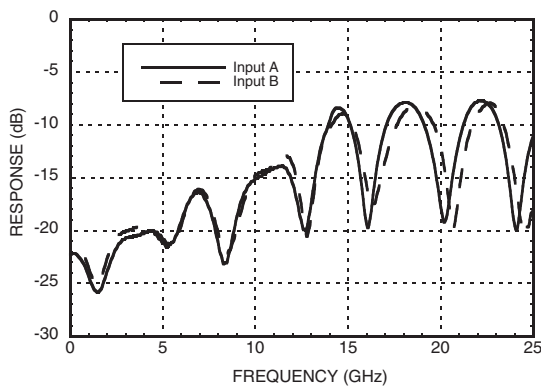

**Output Return Loss vs. Frequency [1][5]**

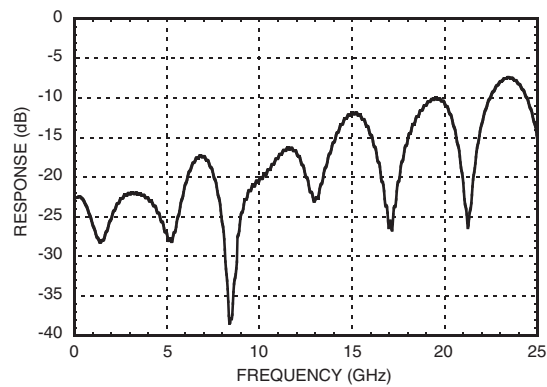

[1] VAC = -0.3V [2] Input data rate: 40 Gbps PRBS 2<sup>23</sup>-1 pattern [3] Data was taken at single ended output  
[4] Source jitter was not deembedded [5] Device measured on evaluation board with single-ended time domain gating.

### 40 Gbps Differential Output Eye Diagram

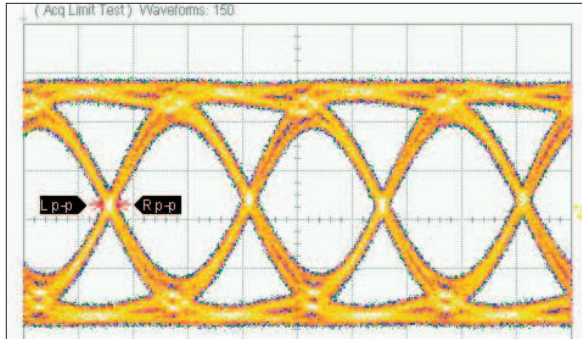

Measurements				
	Current	Min	Max	Total Meas.
Eye Amp	811 mV	811 mV	813 mV	39
Rise Time	12.89 ps	12.67 ps	12.89 ps	39
Fall Time	13.78 ps	13.56 ps	13.78 ps	39
p-p Jitter	3.111 ps	3.111 ps	3.111 ps	39

Time Scale: 10 ps/div  
Amplitude Scale: 200 mV/div

Test Conditions:  
Vee = -3.3V, VAC = -0.3V  
A Input: 40 Gbps PRBS 2<sup>23</sup>-1 pattern, 150 mVp-p single-ended  
B Input: 40 Gbps 10101... pattern, 150 mVp-p single-ended

### Timing Diagram

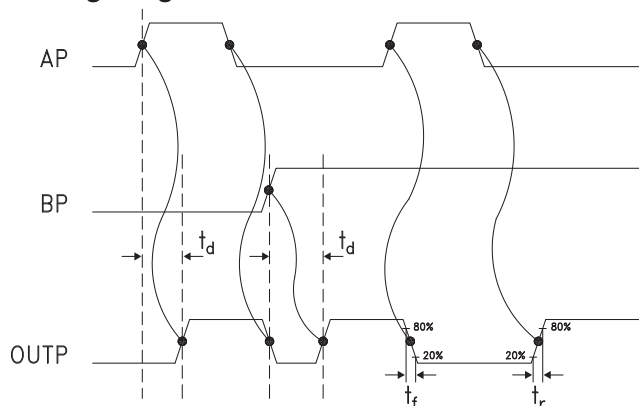

### Truth Table

Input		Outputs
A	B	D
L	L	L
L	H	H
H	L	H
H	H	L

Notes:  
A = AP - AN  
B = BP - BN  
D = OUTP - OUTN

H - Logic High  
L - Logic Low

### Absolute Maximum Ratings

Power Supply Voltage (Vee)	-3.7V to +0.5V
Input Voltage	-1.3V to +0.5V
Output Amplitude Control Voltage (VAC)	-2.3V to +0.5V
Channel Temperature	125°C
Continuous Pdiss (T = 85°C) (derate 24.42 mW/°C above 85°C)	0.98 W
Thermal Resistance (channel to ground paddle)	40.95 °C/W
Storage Temperature	-65°C to +125°C
Operating Temperature	-40°C to +70°C



ELECTROSTATIC SENSITIVE DEVICE  
OBSERVE HANDLING PRECAUTIONS

7

HIGH SPEED LOGIC - SMT

### Outline Drawing

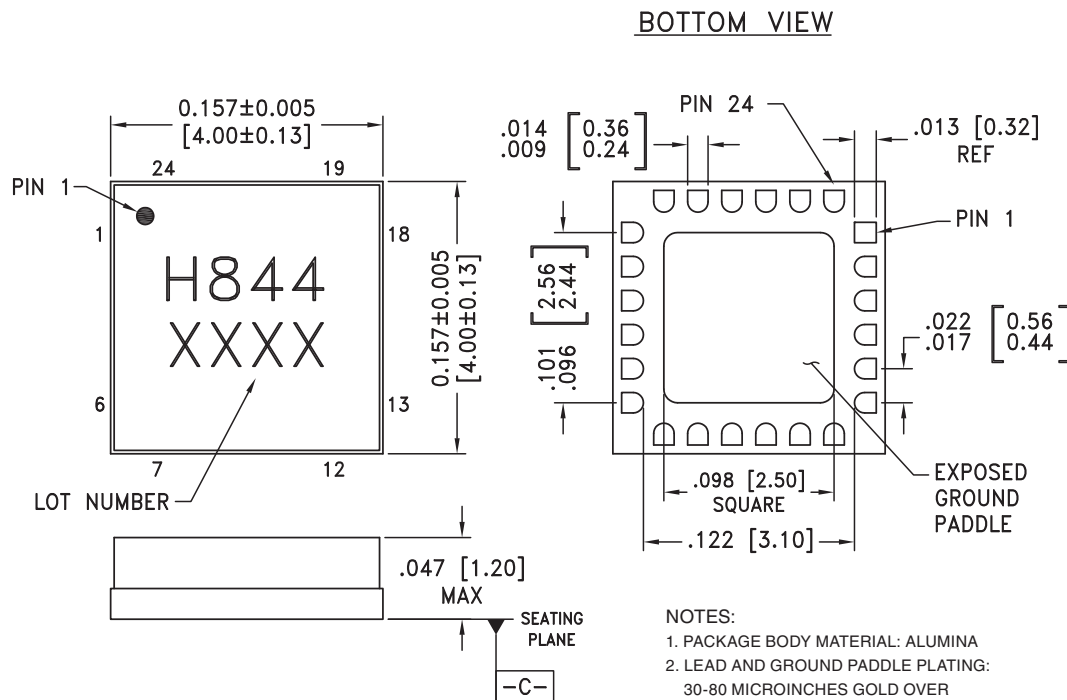

**NOTES:**

1. PACKAGE BODY MATERIAL: ALUMINA
2. LEAD AND GROUND PADDLE PLATING:  
30-80 MICROINCHES GOLD OVER  
50 MICROINCHES MINIMUM NICKEL.
3. DIMENSIONS ARE IN INCHES [MILLIMETERS].
4. LEAD SPACING TOLERANCE IS NON-CUMULATIVE.
5. PACKAGE WARP SHALL NOT EXCEED 0.05mm DATUM  $\square$ -C-
6. ALL GROUND LEADS AND GROUND PADDLE  
MUST BE SOLDERED TO PCB RF GROUND.



### Pin Descriptions

Pin Number	Function	Description	Interface Schematic
1	VAC	Output amplitude control voltage	
2, 5, 8, 11, 14, 17, 21 Package Base	GND	Signal and supply grounds	
3, 4	BN, BP	Differential (BP-BN) or single-ended (BP) data inputs	
6, 7, 12, 13, 18, 19, 24	N/C	The pins are not connected internally; however, all data shown herein was measured with these pins connected to RF/DC ground externally.	
9, 10	OUTP, OUTN	XOR / XNOR outputs	
15, 16	AP, AN	Differential (AP-AN) or single-ended (AP) data inputs	
20, 22, 23	Vee	Power Supply (-3.3V)	

### Evaluation PCB

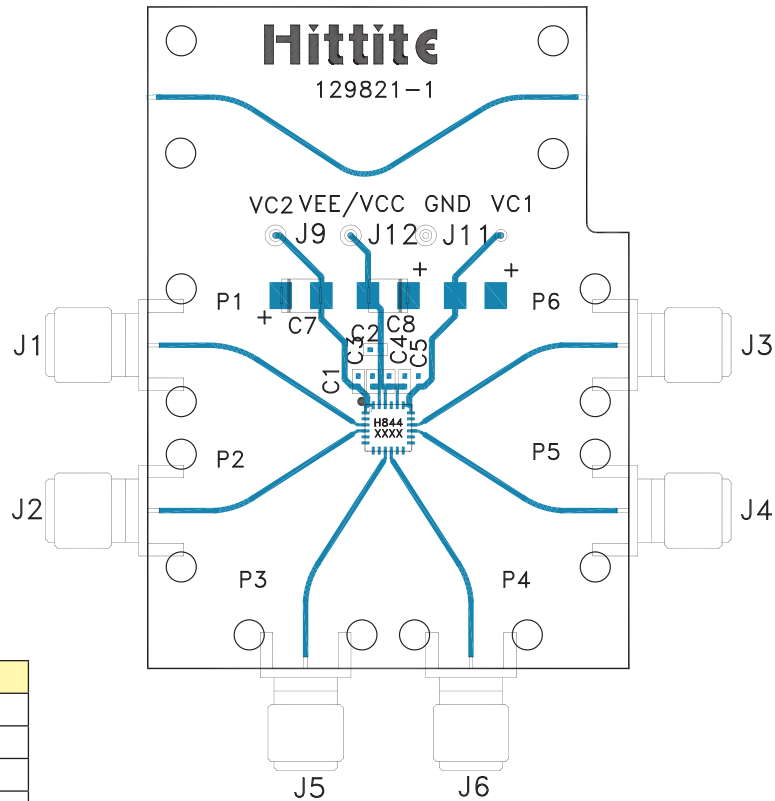

Item	Description
J1	BN
J2	BP
J3	AN
J4	AP
J5	OUTP
J6	OUTN
J9	VAC
J11	GND
J12	Vee

### List of Materials for Evaluation PCB 129821 [1]

Item	Description
J1 - J6	K Connector
J9, J11, J12	DC Pin
C1, C3 - C5	1000 pF Capacitor, 0402 Pkg.
C2	0.1 µF Capacitor, 0402 Pkg.
C7, C8	4.7 µF Capacitor, Tantalum
U1	HMC844LC4B XOR / XNOR
PCB [2]	129821 Evaluation Board

[1] Reference this number when ordering complete evaluation PCB

[2] Circuit Board Material: Arlon 25FR or Rogers 4350

The circuit board used in the application should use RF circuit design techniques. Signal lines should have 50 Ohm impedance while the package ground leads should be connected directly to the ground plane similar to that shown. The exposed metal package base must be connected to Vee. A sufficient number of via holes should be used to connect the top and bottom ground planes. The evaluation circuit board shown is available from Hittite upon request.

### Application Circuit

