

DATA SHEET

SKY13322-375LF: 20 MHz-6.0 GHz GaAs SP4T Switch

Applications

- Multiband telecommunications up to 6 GHz

Features

- Broadband frequency range: 20 MHz to 6.0 GHz
- Low insertion loss: 0.45 dB @ 1 GHz
- Very high isolation: 28 dB @ 1 GHz
- Excellent linearity performance: P1dB = +30 dBm @ 3.3 V
- Operating voltage range from 1.8 to 5.0 V
- Small, MLPD (10-pin, 2 x 3 mm) package (MSL1, 260 °C per JEDEC J-STD-020)

Description

The SKY13322-375LF is a GaAs FET I/C single-pole, four-throw (SP4T) switch. This general purpose switch is an ideal choice for a variety of multiband telecommunication applications up to 6 GHz.

The switch is manufactured in a compact, 2 x 3 mm, 10-pin exposed pad plastic Micro Leadframe Package Dual (MLPD) package.

A functional block diagram is shown in Figure 1. The pin configuration and package are shown in Figure 2. Signal pin assignments and functional pin descriptions are provided in Table 1.

NEW



Skyworks Green™ products are RoHS (Restriction of Hazardous Substances)-compliant, conform to the EIA/EICTA/JEITA Joint Industry Guide (JIG) Level A guidelines, are halogen free according to IEC-61249-2-21, and contain <1,000 ppm antimony trioxide in polymeric materials.

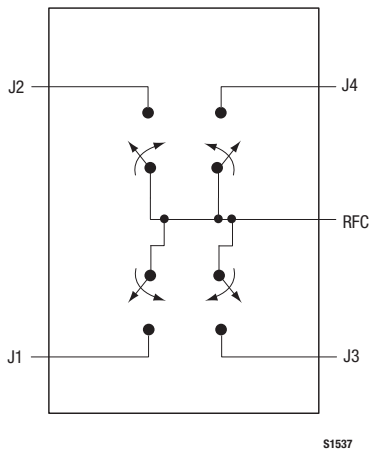

Figure 1. SKY13322-375LF Block Diagram

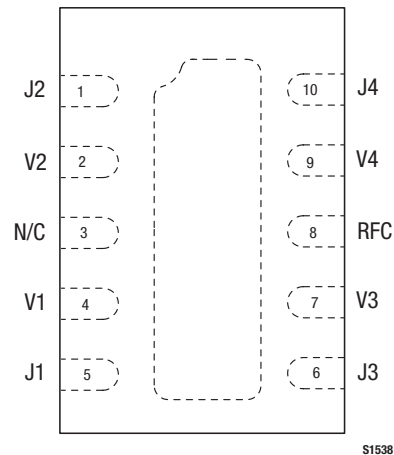

Figure 2. SKY13322-375LF Pinout – 10-Pin MLPD (Top View)

Table 1. SKY13322-375LF Signal Descriptions

Pin #	Name	Description	Pin #	Name	Description
1	J2	RF output (Note 1)	6	J3	RF output (Note 1)
2	V2	DC control voltage	7	V3	DC control voltage
3	N/C	No connection	8	RFC	RF common input (Note 1)
4	V1	DC control voltage	9	V4	DC control voltage
5	J1	RF output (Note 1)	10	J4	RF output (Note 1)

Note 1: A 47 pF blocking capacitor is required for >1 GHz operation. Use larger value capacitors for lower frequency operation.

Table 2. SKY13322-375LF Absolute Maximum Ratings

Parameter	Symbol	Minimum	Typical	Maximum	Units
Input power	P _{IN}		+33		dBm
Voltage range	V _{CTL}		6		V
Storage temperature	T _{STG}	-65		+150	°C
Operating temperature	T _{OP}	-40		+85	°C

Note: Exposure to maximum rating conditions for extended periods may reduce device reliability. There is no damage to device with only one parameter set at the limit and all other parameters set at or below their nominal value. Exceeding any of the limits listed here may result in permanent damage to the device.

CAUTION: Although this device is designed to be as robust as possible, Electrostatic Discharge (ESD) can damage this device. This device must be protected at all times from ESD. Static charges may easily produce potentials of several kilovolts on the human body or equipment, which can discharge without detection. Industry-standard ESD precautions should be used at all times.

Table 3. SKY13322-375LF Recommended Operating Conditions

Parameter	Symbol	Minimum	Typical	Maximum	Units
Frequency	f	0.02		6.0	GHz
Control voltage:					
Low	V _{CTL_L}	0		0.2	V
High	V _{CTL_H}	1.8	3.3	5.0	V

Electrical and Mechanical Specifications

The absolute maximum ratings of the SKY13322-375LF are provided in Table 2. The recommended operating conditions are specified in Table 3 and electrical specifications are provided in Table 4.

Typical performance characteristics of the SKY13322-375LF are illustrated in Figures 3 through 8.

The state of the SKY13322-375LF is determined by the logic provided in Table 5.

Table 4. SKY13322-375LF Electrical Specifications (Note 1)**($V_{CTL} = 0\text{ V}$ and $+3.3\text{ V}$, $T_{OP} = +25\text{ }^{\circ}\text{C}$, $P_{IN} = 0\text{ dBm}$, Characteristic Impedance [Z_0] = $50\text{ }\Omega$, Unless Otherwise Noted)**

Parameter	Symbol	Test Condition	Min	Typical	Max	Units
Insertion loss	IL	0.02-1.0 GHz		0.45	0.60	dB
		1.0-2.5 GHz		0.60	0.75	dB
		2.5-3.0 GHz		0.75	0.95	dB
		3.0-4.0 GHz		1.00	1.25	dB
		4.0-6.0 GHz		2.00		dB
Isolation	Iso	0.02-1.0 GHz	26	28		dB
		1.0-2.5 GHz	23	26		dB
		2.5-3.0 GHz	23	27		dB
		3.0-4.0 GHz	23	27		dB
		4.0-6.0 GHz		18		dB
Return loss (insertion loss state)		0.02-1.0 GHz	15	22		dB
		1.0-2.5 GHz	15	22		dB
		2.5-3.0 GHz	15	22		dB
		3.0-4.0 GHz	10	13		dB
		4.0-6.0 GHz		7.5		dB
Switching characteristics: Rise/fall time On/off time		10/90% or 90/10% RF		60		ns
		50% V_{CTL} to 90/10% RF		60		ns
Video feedthrough				40		mV
1 dB Input Compression Point	IP1dB	f = 0.9 GHz/2.45 GHz				
		$V_{CTL} = 0\text{ V}/1.8\text{ V}$,		+21.0		dBm
		$V_{CTL} = 0\text{ V}/2.7\text{ V}$		+27.5		dBm
		$V_{CTL} = 0\text{ V}/3.3\text{ V}$		+30.0		dBm
0.1 dB Input Compression Point	IP0.1dB	f = 0.9 GHz/2.45 GHz				
		$V_{CTL} = 0\text{ V}/1.8\text{ V}$,		+17.5		dBm
		$V_{CTL} = 0\text{ V}/2.7\text{ V}$		+24.5		dBm
		$V_{CTL} = 0\text{ V}/3.3\text{ V}$		+27.0		dBm
Input IP3	IIP3	$P_{IN} = +15\text{ dBm}/\text{tone}$, tone spacing = 1 MHz				
		f = 0.9 GHz,		+54		dBm
		f = 2.45 GHz		+51		dBm
2 nd harmonic	2fo	$P_{IN} = +17\text{ dBm}$				
		f = 0.9 GHz f = 2.45 GHz		76 70		dBc dBc
3 rd harmonic	3fo	$P_{IN} = +17\text{ dBm}$				
		f = 0.9 GHz f = 2.45 GHz		70 65		dBc dBc
Supply current	I_{CC}	$V_{CTL} = 1.8\text{ V}$ to 5.0 V		5		μA

Note 1: Performance is guaranteed only under the conditions listed in this Table.

Typical Performance Characteristics

($V_{CTL} = 0\text{ V}$ and $+3.3\text{ V}$, $T_{OP} = +25\text{ }^{\circ}\text{C}$, $P_{IN} = 0\text{ dBm}$, Characteristic Impedance [Z_0] = $50\ \Omega$, Blocking Capacitors = 47 pF , Unless Otherwise Noted)

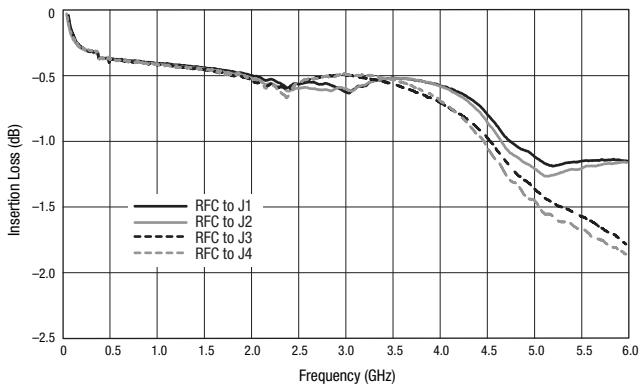

Figure 3. Insertion Loss vs Frequency

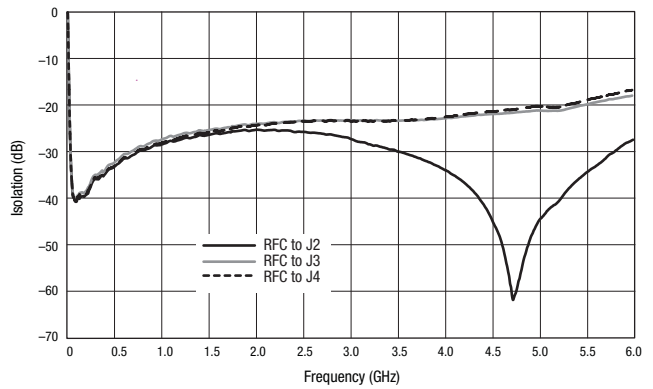

Figure 4. Isolation vs Frequency (RFC to J1 Insertion Loss State)

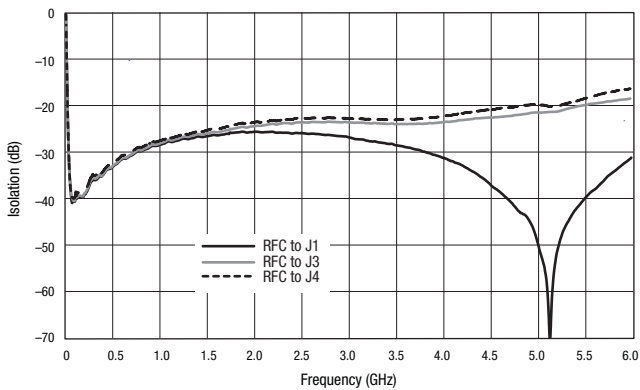

Figure 5. Isolation vs Frequency (RFC to J2 Insertion Loss State)

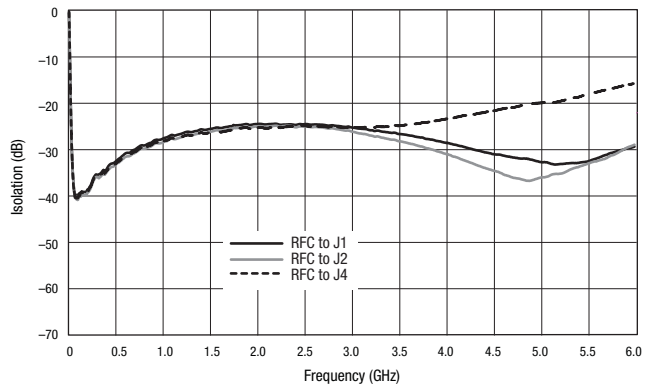

Figure 6. Isolation vs Frequency (RFC to J3 Insertion Loss State)

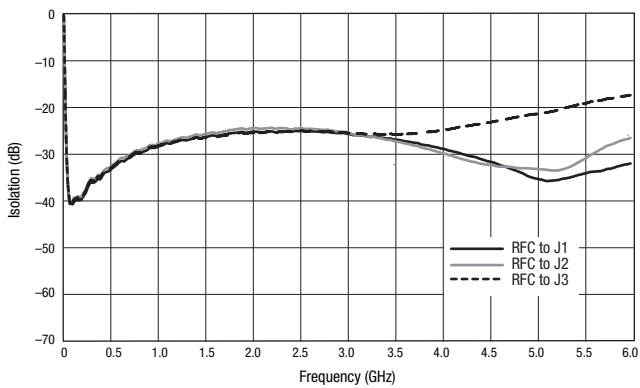

Figure 7. Isolation vs Frequency (RFC to J4 Insertion Loss State)

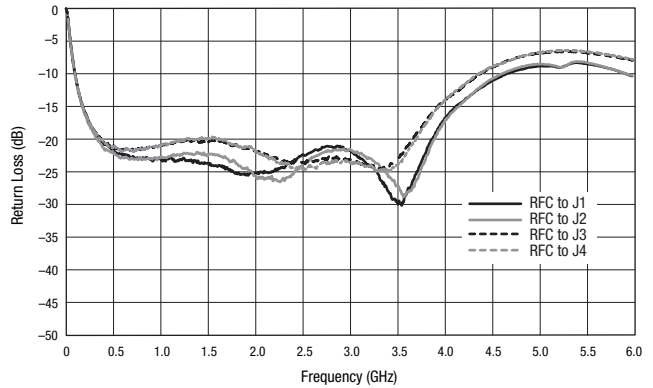

Figure 8. RFC Return Loss vs Frequency

Table 5. SKY13322-375LF Truth Table

V1 (Pin 4)	V2 (Pin 2)	V3 (Pin 7)	V4 (Pin 9)	RFC to J1	RFC to J2	RFC to J3	RFC to J4
1	0	0	0	Insertion loss	Isolation	Isolation	Isolation
0	1	0	0	Isolation	Insertion loss	Isolation	Isolation
0	0	1	0	Isolation	Isolation	Insertion loss	Isolation
0	0	0	1	Isolation	Isolation	Isolation	Insertion loss

Note: "1" = +1.8 V to +5 V. "0" = 0 V to +0.2 V. Any state other than described in this Table places the switch into an undefined state. An undefined state will not damage the device.

Evaluation Board Description

The SKY13322-375LF Evaluation Board is used to test the performance of the SKY13322-375LF SPDT Switch. An Evaluation Board schematic diagram is provided in Figure 9. An assembly drawing for the Evaluation Board is shown in Figure 10.

Package Dimensions

The PCB layout footprint for the SKY13322-375LF is provided in Figure 11. Typical case markings are shown in Figure 12. Package dimensions for the 10-pin MLPD are shown in Figure 13, and tape and reel dimensions are provided in Figure 14.

Package and Handling Information

Since the device package is sensitive to moisture absorption, it is baked and vacuum packed before shipping. Instructions on the shipping container label regarding exposure to moisture after the container seal is broken must be followed. Otherwise, problems related to moisture absorption may occur when the part is subjected to high temperature during solder assembly.

THE SKY13322-375LF is rated to Moisture Sensitivity Level 1 (MSL1) at 260 °C. It can be used for lead or lead-free soldering.

Care must be taken when attaching this product, whether it is done manually or in a production solder reflow environment. Production quantities of this product are shipped in a standard tape and reel format.

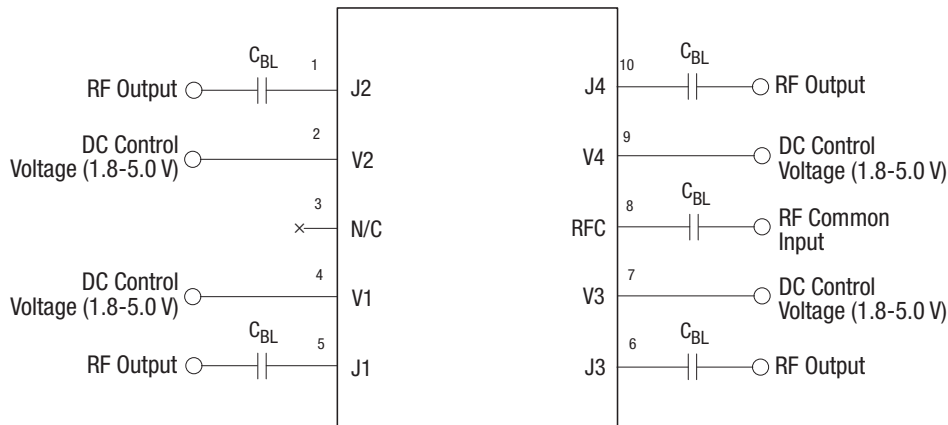

$C_{BL} = 47 \text{ pF}$ for >1 GHz operation.
Exposed ground paddle should be grounded for best performance.

Use 10 nF blocking capacitors (C_{BL}) for <50 MHz operation.

S1551

Figure 9. SKY13322-375LF Evaluation Board Schematic

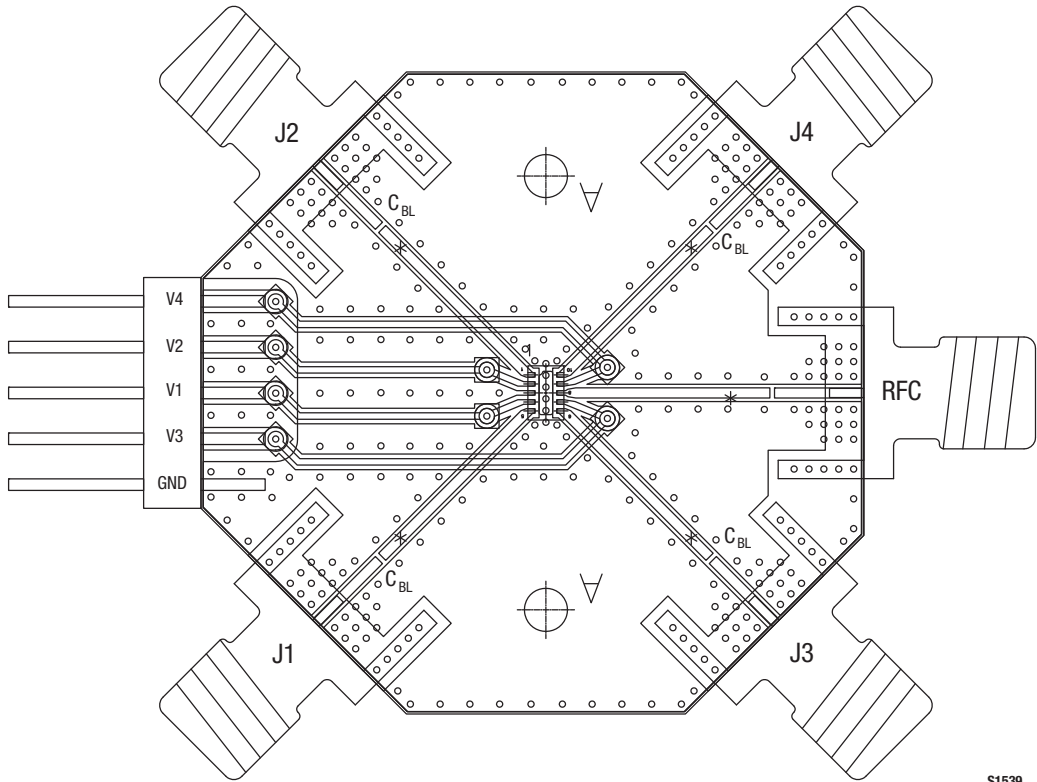

S1539

Figure 10. SKY13322-375LF Evaluation Board Assembly Diagram

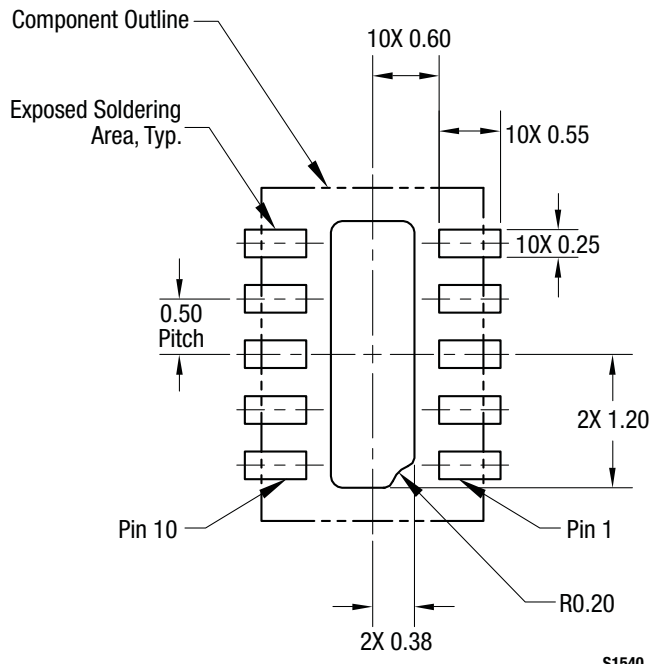

S1540

Figure 11. SKY13322-375LF PCB Layout Footprint (Top View)

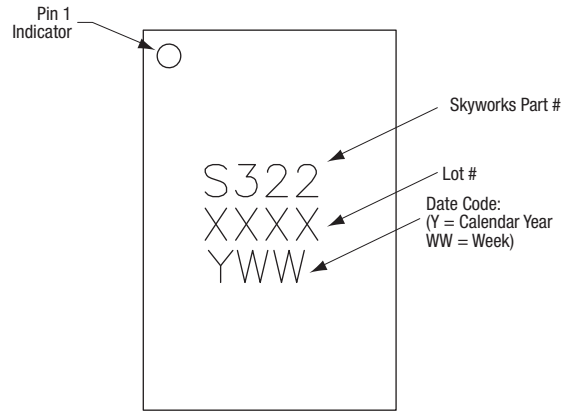
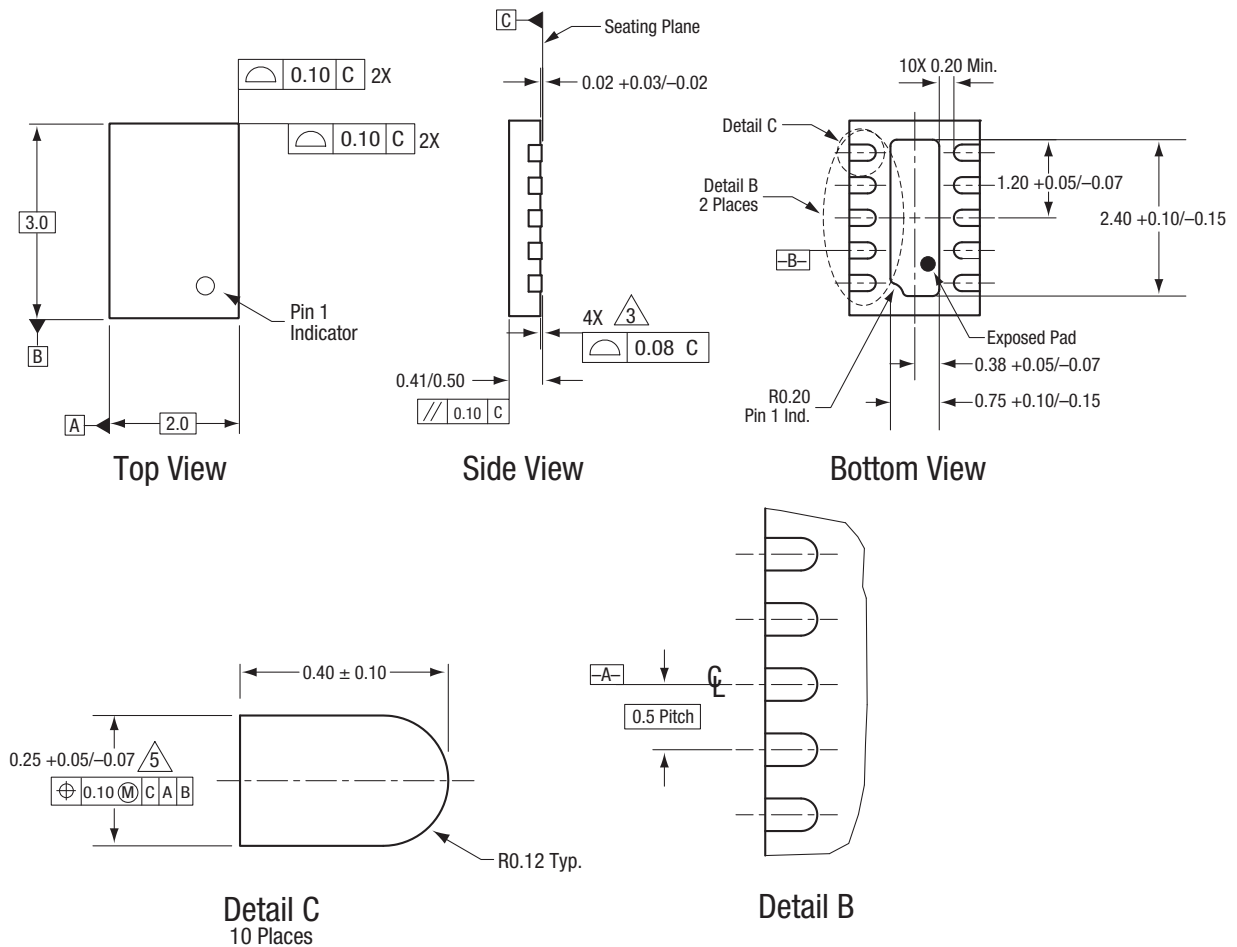

Figure 12. Typical Case Markings (Top View)



All measurements are in millimeters.
 Dimensioning and tolerancing according to ASME Y14.5M-1994.
 Coplanarity applies to the exposed heat sink slug as well as the terminals.
 Plating requirement per source control drawing (SCD) 2504.
 Dimension applies to metallized terminal and is measured between 0.15 mm and 0.30 mm from terminal tip.

S1541

Figure 13. SKY13322-375LF 6-Pin QFN Package Dimensions

DATA SHEET • SKY13322-375LF SP4T SWITCH

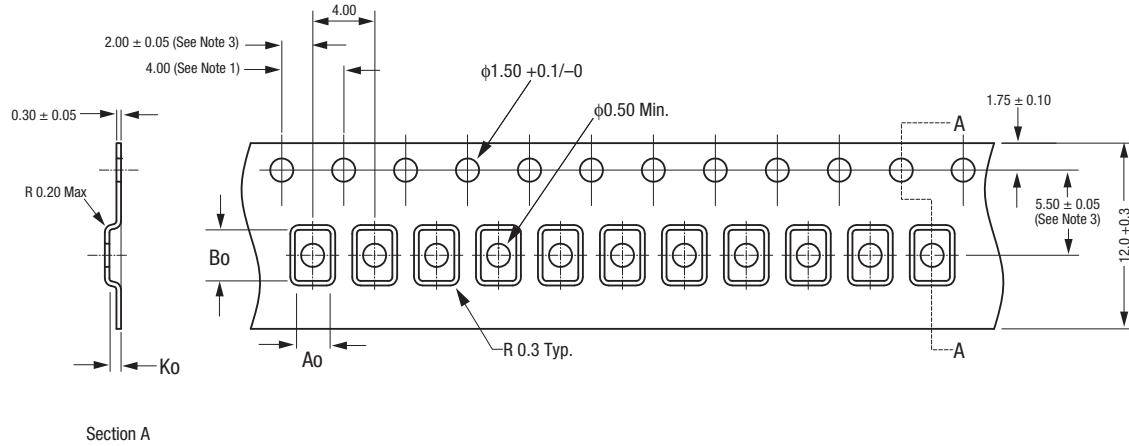

- Notes:
- | | |
|--|--------------|
| 1. 10 sprocket hole pitch cumulative tolerance ± 0.2 . | $A_0 = 2.30$ |
| 2. Chamfer in compliance with EIA 481. | $B_0 = 3.30$ |
| 3. Pocket position relative to sprocket hole measured as true position of pocket, not pocket hole. | $K_0 = 0.75$ |
| 4. Carrier tape: black conductive polycarbonate or polystyrene. | |
| 5. Cover tape material: transparent conductive PSA. | |
| 6. Cover tape size: 9.3mm width. | |
| 7. All measurements are in millimeters. | |

S1552

Figure 14. SKY13322-375LF Tape and Reel Dimensions

Ordering Information

Model Name	Manufacturing Part Number	Evaluation Kit Part Number
SKY13322-375LF SP4T Switch	SKY13322-375LF	SKY13322-375LF-EVB

Copyright © 2009, 2010 Skyworks Solutions, Inc. All Rights Reserved.

Information in this document is provided in connection with Skyworks Solutions, Inc. ("Skyworks") products or services. These materials, including the information contained herein, are provided by Skyworks as a service to its customers and may be used for informational purposes only by the customer. Skyworks assumes no responsibility for errors or omissions in these materials or the information contained herein. Skyworks may change its documentation, products, services, specifications or product descriptions at any time, without notice. Skyworks makes no commitment to update the materials or information and shall have no responsibility whatsoever for conflicts, incompatibilities, or other difficulties arising from any future changes.

No license, whether express, implied, by estoppel or otherwise, is granted to any intellectual property rights by this document. Skyworks assumes no liability for any materials, products or information provided hereunder, including the sale, distribution, reproduction or use of Skyworks products, information or materials, except as may be provided in Skyworks Terms and Conditions of Sale.

THE MATERIALS, PRODUCTS AND INFORMATION ARE PROVIDED "AS IS" WITHOUT WARRANTY OF ANY KIND, WHETHER EXPRESS, IMPLIED, STATUTORY, OR OTHERWISE, INCLUDING FITNESS FOR A PARTICULAR PURPOSE OR USE, MERCHANTABILITY, PERFORMANCE, QUALITY OR NON-INFRINGEMENT OF ANY INTELLECTUAL PROPERTY RIGHT; ALL SUCH WARRANTIES ARE HEREBY EXPRESSLY DISCLAIMED. SKYWORKS DOES NOT WARRANT THE ACCURACY OR COMPLETENESS OF THE INFORMATION, TEXT, GRAPHICS OR OTHER ITEMS CONTAINED WITHIN THESE MATERIALS. SKYWORKS SHALL NOT BE LIABLE FOR ANY DAMAGES, INCLUDING BUT NOT LIMITED TO ANY SPECIAL, INDIRECT, INCIDENTAL, STATUTORY, OR CONSEQUENTIAL DAMAGES, INCLUDING WITHOUT LIMITATION, LOST REVENUES OR LOST PROFITS THAT MAY RESULT FROM THE USE OF THE MATERIALS OR INFORMATION, WHETHER OR NOT THE RECIPIENT OF MATERIALS HAS BEEN ADVISED OF THE POSSIBILITY OF SUCH DAMAGE.

Skyworks products are not intended for use in medical, lifesaving or life-sustaining applications, or other equipment in which the failure of the Skyworks products could lead to personal injury, death, physical or environmental damage. Skyworks customers using or selling Skyworks products for use in such applications do so at their own risk and agree to fully indemnify Skyworks for any damages resulting from such improper use or sale.

Customers are responsible for their products and applications using Skyworks products, which may deviate from published specifications as a result of design defects, errors, or operation of products outside of published parameters or design specifications. Customers should include design and operating safeguards to minimize these and other risks. Skyworks assumes no liability for applications assistance, customer product design, or damage to any equipment resulting from the use of Skyworks products outside of stated published specifications or parameters.

Skyworks, the Skyworks symbol, and "Breakthrough Simplicity" are trademarks or registered trademarks of Skyworks Solutions, Inc., in the United States and other countries. Third-party brands and names are for identification purposes only, and are the property of their respective owners. Additional information, including relevant terms and conditions, posted at www.skyworksinc.com, are incorporated by reference.