

FILTER - TUNABLE, BAND PASS SMT 11.5 - 21.5 GHz



Typical Applications

The HMC898LP4E is ideal for:

- Test & Measurement Equipment
- Military RADAR & EW/ECM
- SATCOM & Space
- Industrial & Medical Equipment

Functional Diagram

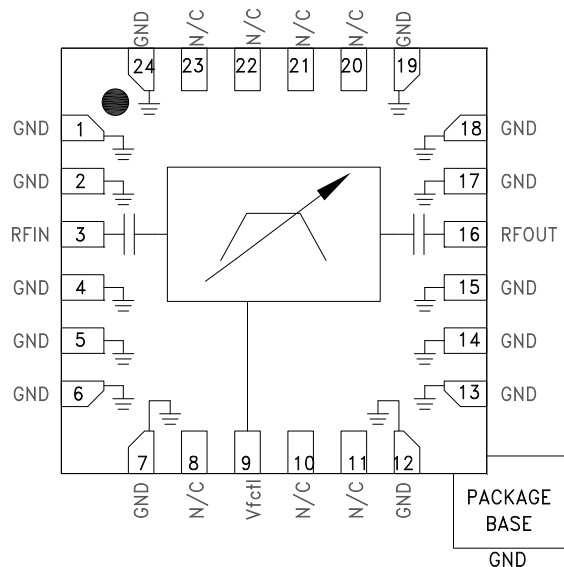

Features

- Fast Tuning Response
- Excellent Wideband Rejection
- Single Chip Replacement for Mechanically Tuned Designs
- 24 Lead 4x4 mm SMT Package

General Description

The HMC898LP4E is a MMIC band pass filter which features a user selectable passband frequency. The 3 dB filter bandwidth is approximately 17%. The 20 dB filter bandwidth is approximately 35%. The center frequency can be varied between 11.5 and 21.5 GHz by applying an analog tune voltage between 0 and 14V. This tunable filter can be used as a much smaller alternative to physically large switched filter banks and cavity tuned filters. The HMC898LP4E has excellent microphonics due to the monolithic design, and provides a dynamically adjustable solution in advanced communications applications.

Electrical Specifications, $T_A = +25\text{ }^\circ\text{C}$

Parameter	Min.	Typ.	Max.	Units
F_{center} Tuning Range	11.5		21.5	GHz
3 dB Bandwidth		17		%
Low Side Rejection Frequency (Rejection >20 dB)		$0.81 * F_{center}$		GHz
High Side Rejection Frequency (Rejection >20 dB)		$1.16 * F_{center}$		GHz
Low Side Sub-Harmonic Rejection (Rejection >40 dB)		$0.55 * F_{center}$		GHz
High Side Sub-Harmonic Rejection (Rejection >40 dB)		$1.27 * F_{center}$		GHz
Re-entry Frequency (Rejection <30 dB)		>40		GHz
Insertion Loss		6		dB
Return Loss (2 dB Bandwidth)		9		dB
Input IP3 (Pin = 0 to +15 dBm)		29		dBm
Input Power @ 5° Shift In Insertion Phase ($V_{ctl} = 0V$)		9		dBm
Input Power @ 5° Shift In Insertion Phase ($V_{ctl} = 1V$)		14		dBm
Frequency Control Voltage (V_{ctl})	0		14	V
Source/Sink Current (I_{ctl})			±1	mA
Residual Phase Noise ^[1] (100 kHz Offset)		-157		dBc/Hz
F_{center} Drift Rate		-1.9		MHz/°C
Tuning Speed, Phase Settling to within 10° ^[2]		< 200		ns

[1] Optimum residual phase noise performance requires the use of a low noise driver circuit.

[2] Tuning speed includes 40 ns tuning voltage ramp from driver.



**FILTER - TUNABLE, BAND PASS SMT
11.5 - 21.5 GHz**

Broadband Insertion Loss vs. V_{ctrl}

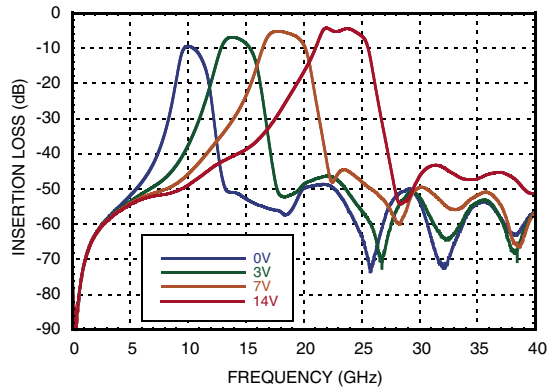

Broadband Return Loss vs. V_{ctrl}

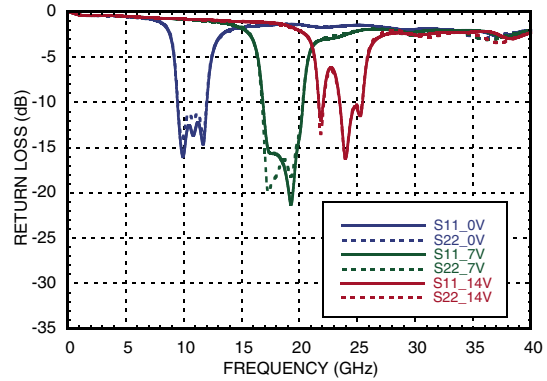

Insertion Loss vs. V_{ctrl}

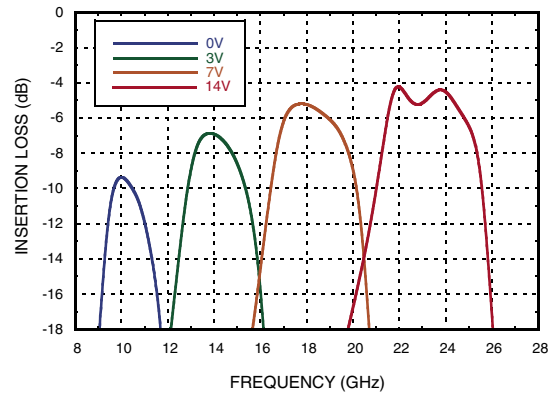

Return Loss vs. V_{ctrl}

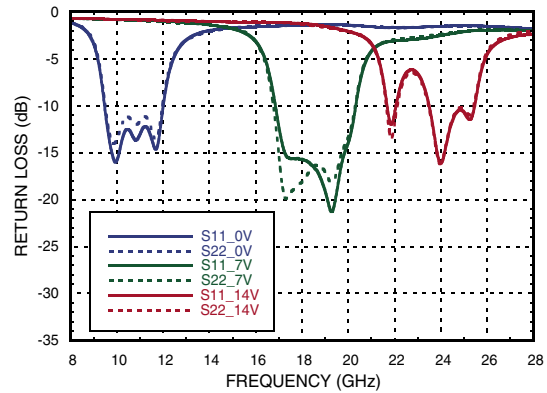

Insertion Loss vs. Temperature, V_{ctrl} = 7V

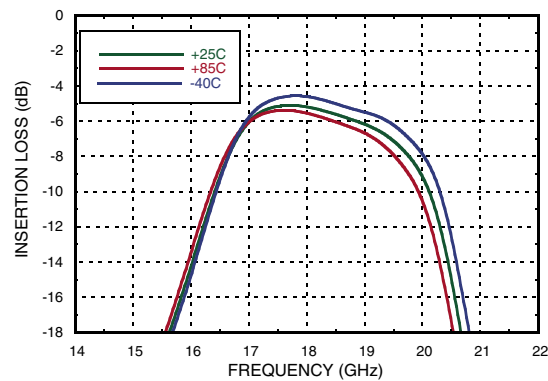

Return Loss vs. Temperature, V_{ctrl} = 7V

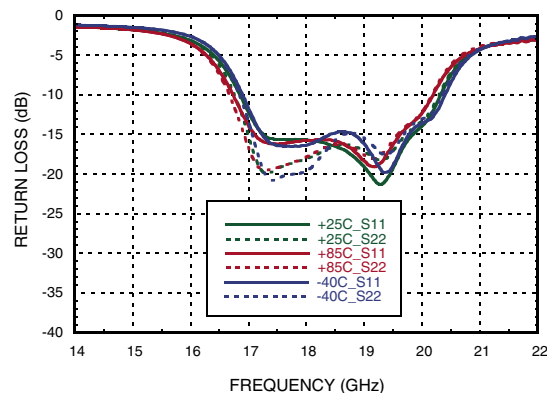

Center Frequency vs. Temperature

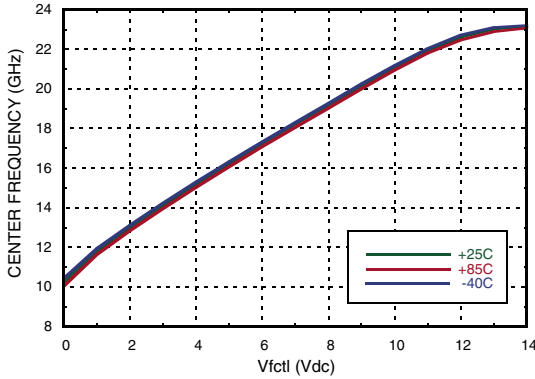

Insertion Loss vs. Temperature

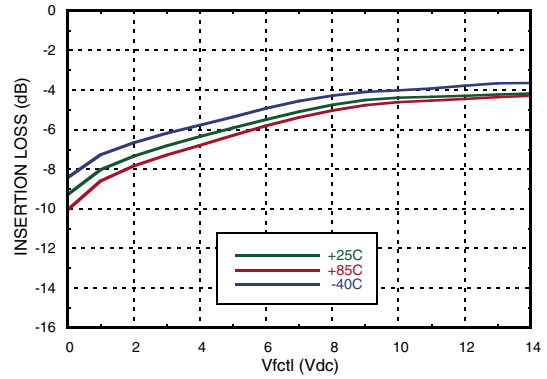

3 dB Bandwidth vs. Temperature

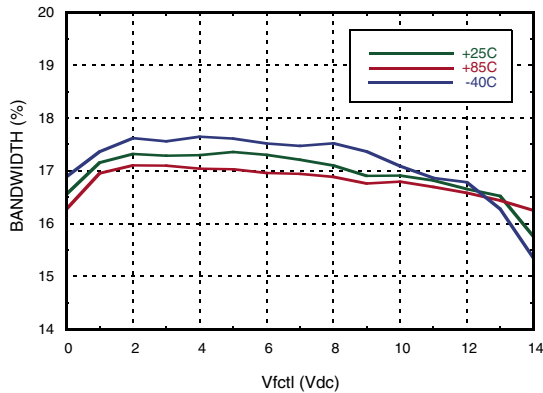

Return Loss in a 2 dB Bandwidth vs. Temperature

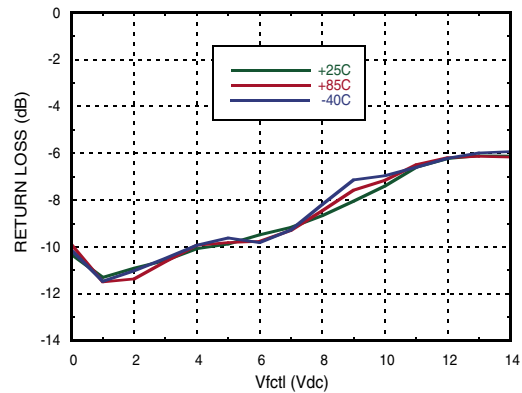

Low Side Rejection Ratio vs. Temperature [1]

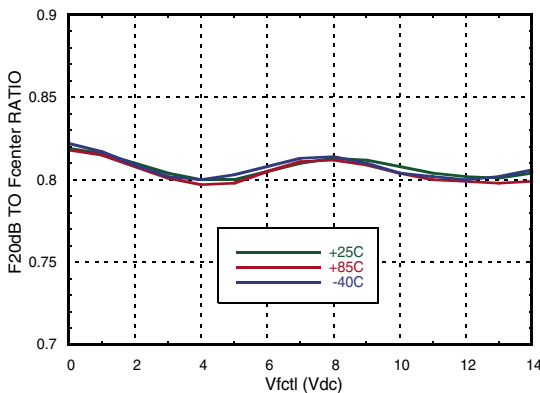

High Side Rejection Ratio vs. Temperature [1]

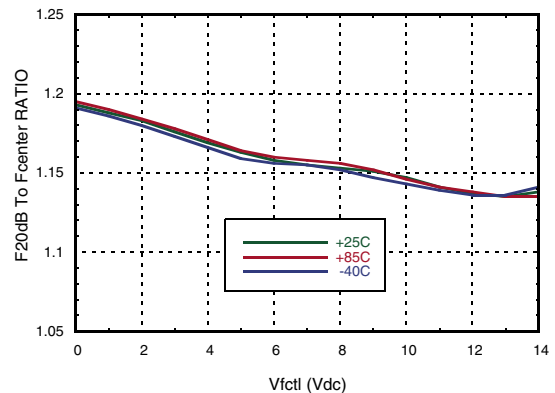

[1] Rejection ratio is defined as the ratio of the frequency at which the relative insertion loss is 20 dB to fcenter



**FILTER - TUNABLE, BAND PASS SMT
11.5 - 21.5 GHz**

Tuning Sensitivity vs. Temperature

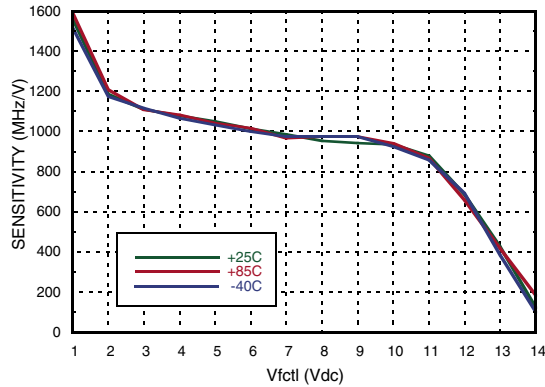

Group Delay vs. Frequency

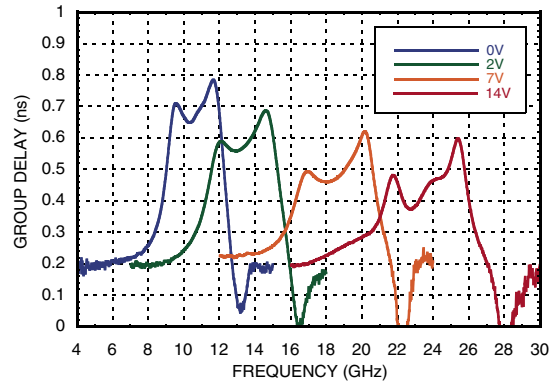

Group Delay vs. Fcenter vs. Temperature

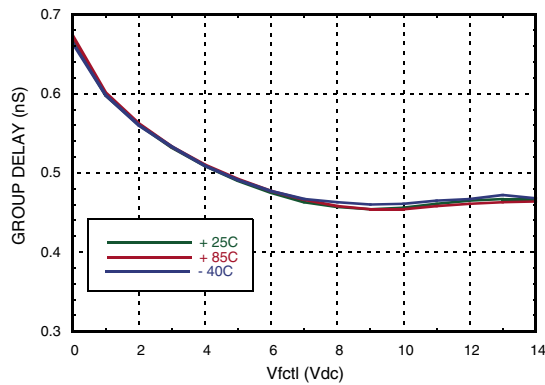

Input IP3 vs. Temperature

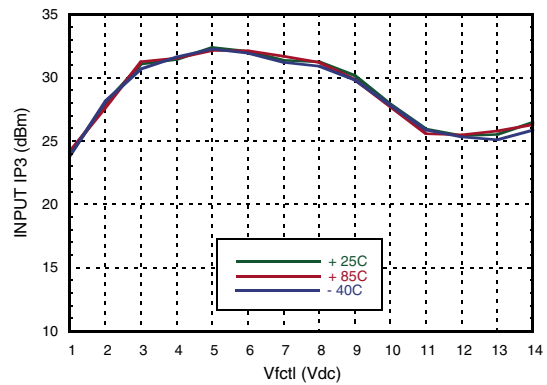

Residual Phase Noise

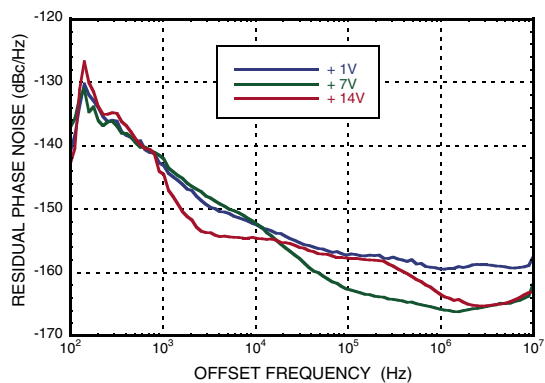

Phase Sensitivity vs. Vctrl

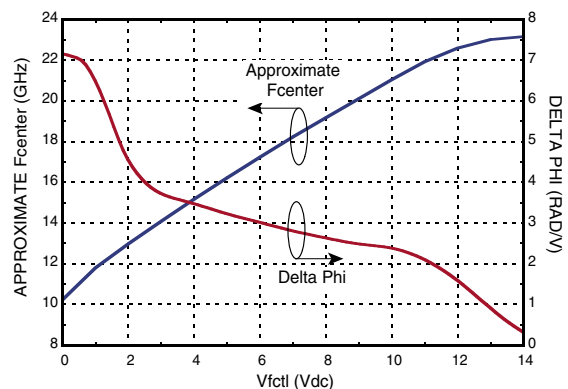

FILTER - TUNABLE, BAND PASS SMT 11.5 - 21.5 GHz



Insertion Phase vs. Input Power

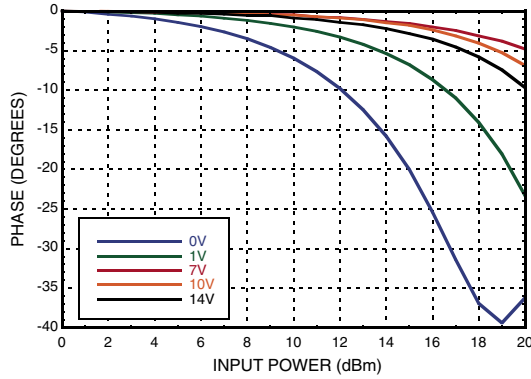

Fcenter vs. Input Power

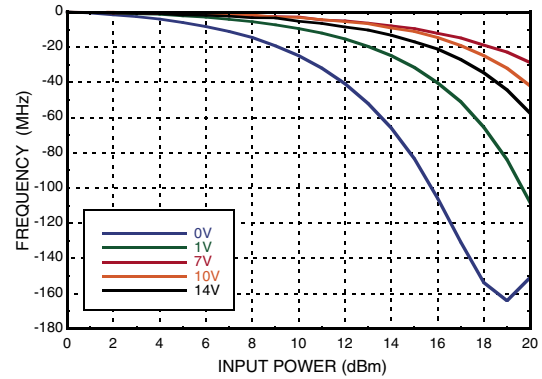

Absolute Maximum Ratings

Frequency Control Voltage (Vfctl)	-0.5 to +15V
RF Power Input	27 dBm
Storage Temperature	-65 to +150 °C
ESD Sensitivity (HBM)	Class 1 A

Reliability Information

Junction Temperature to Maintain 1 Million Hour MTTF	150 °C
Nominal Junction Temperature (T= 85 °C and Pin = 27 dBm)	103 °C
Operating Temperature	-40 to +85 °C

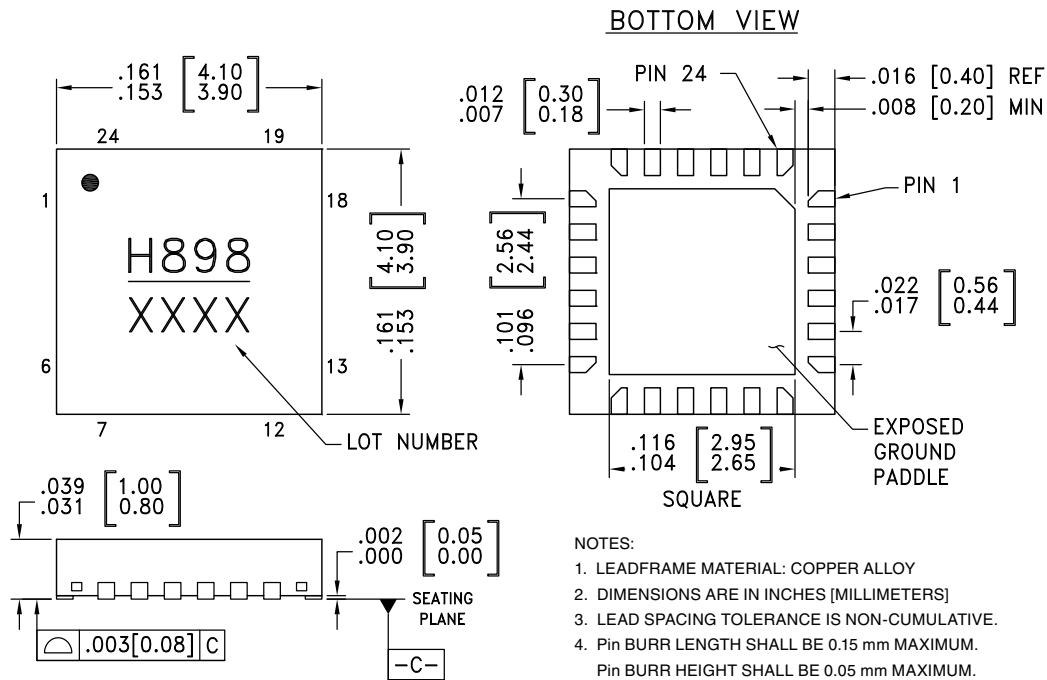

**ELECTROSTATIC SENSITIVE DEVICE
OBSERVE HANDLING PRECAUTIONS**

Outline Drawing

NOTES:

1. LEADFRAME MATERIAL: COPPER ALLOY
2. DIMENSIONS ARE IN INCHES [MILLIMETERS]
3. LEAD SPACING TOLERANCE IS NON-CUMULATIVE.
4. Pin BURR LENGTH SHALL BE 0.15 mm MAXIMUM.
Pin BURR HEIGHT SHALL BE 0.05 mm MAXIMUM.
5. PACKAGE WARP SHALL NOT EXCEED 0.05 mm.
6. ALL GROUND LEADS AND GROUND PADDLE MUST BE SOLDERED TO PCB RF GROUND.
7. REFER TO HITTITE APPLICATION NOTE FOR SUGGESTED LAND PATTERN.

Package Information

Part Number	Package Body Material	Lead Finish	MSL Rating	Package Marking ^[1]
HMC898LP4E	RoHS-compliant Low Stress Injection Molded Plastic	100% matte Sn	MSL1 ^[2]	H898 XXXX

[1] 4-Digit lot number XXXX

[2] Max peak reflow temperature of 260 °C



Pin Descriptions

Pin Number	Function	Description	Interface Schematic
1, 2, 4 - 7, 12 - 15, 17 - 19, 24	GND	These pins and exposed paddle must be connected to RF/DC ground.	
8, 10, 11, 20 - 23	NC	The pins are not connected internally; however, all data shown herein was measured with these pins connected to RF/DC ground externally.	
3	RFIN	This pin is AC coupled and matched to 50 Ohms.	
9	Vfctl	Center frequency control voltage.	
16	RFOUT	This pin is AC coupled and matched to 50 Ohms.	

Application Circuit

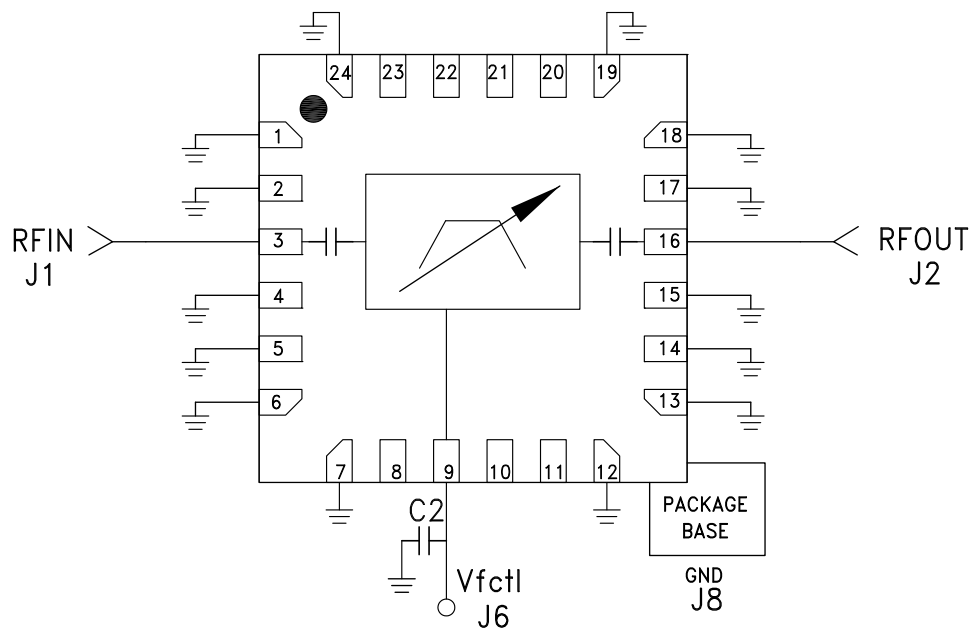

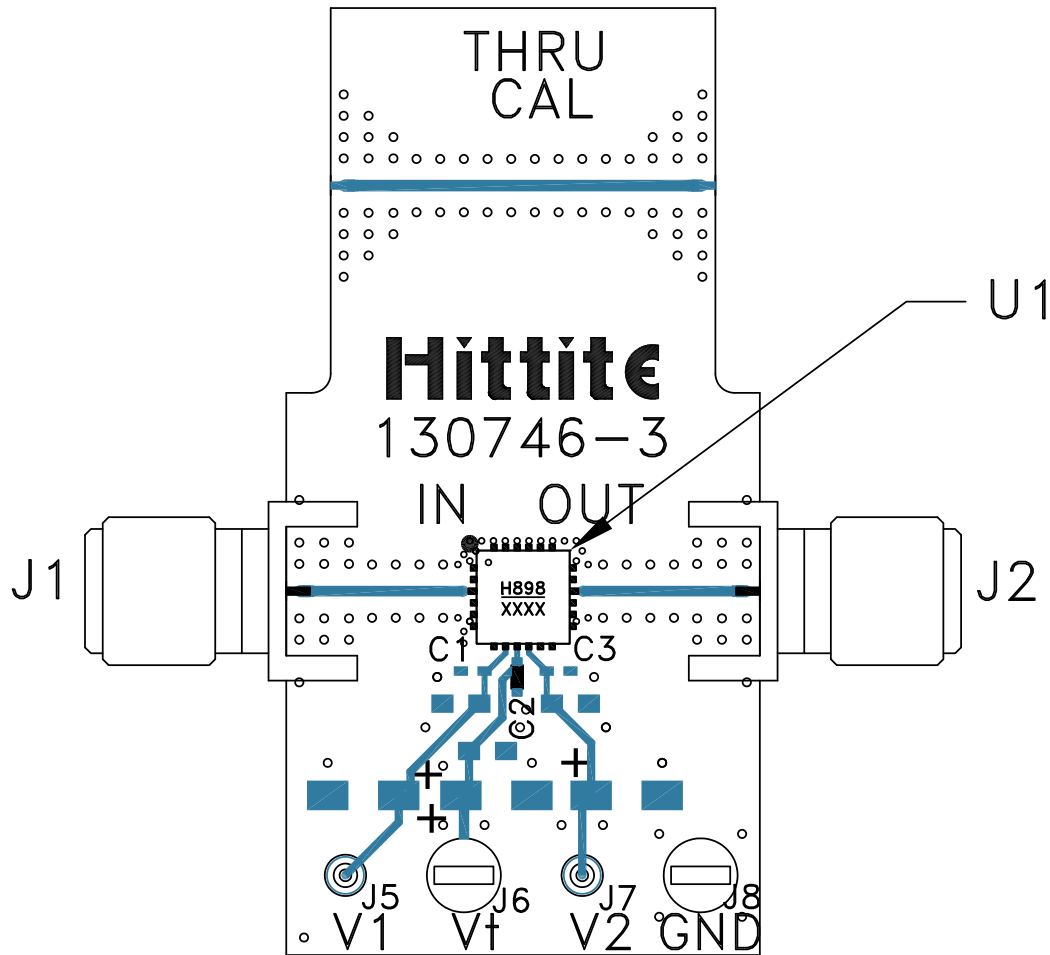
Evaluation PCB

List of Materials for Evaluation PCB 131086 [1]

Item	Description
J1, J2	Connector, 2.9 mm, Female
J6, J8	DC Pin
C2	100 pF Capacitor, 0402 Pkg.
U1	HMC898LP4E Filter - Tunable
PCB [2]	130746 Evaluation PCB

[1] Reference this number when ordering complete evaluation PCB

[2] Circuit Board Material: Arlon 25FR or Rogers 25FR

The circuit board used in the application should use RF circuit design techniques. Signal lines should have 50 Ohms impedance while the package ground leads and exposed paddle should be connected directly to the ground plane similar to that shown. A sufficient number of via holes should be used to connect the top and bottom ground planes. The evaluation circuit board shown is available from Hittite upon request.