



SMT GaAs MMIC x2 ACTIVE FREQUENCY MULTIPLIER, 25 - 31 GHz OUTPUT

Typical Applications

The HMC942LP4E is ideal for:

- Clock Generation Applications:
SONET OC-192 & SDH STM-64
- Point-to-Point & VSAT Radios
- Test Instrumentation
- Military & Space
- Sensors

Features

- High Output Power: +21 dBm
- Low Input Power Drive: 0 to +6 dBm
- Fo Isolation: >45 dBc
- Single Supply: +4.5V @ 214 mA
- 24 Lead 4x4 mm SMT Package: 16 mm²

Functional Diagram

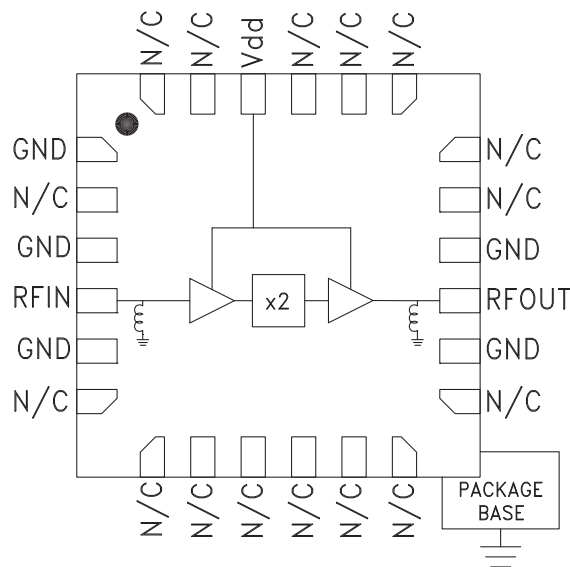

General Description

The HMC942LP4E is a x2 active broadband frequency multiplier utilizing GaAs pHEMT technology in a leadless RoHS compliant SMT package. When driven by a +4 dBm signal, the multiplier provides +17 dBm typical output power from 13 to 24.6 GHz. The Fo and 3Fo isolations are >20 dBc at 19 GHz. The HMC942LP4E is ideal for use in LO multiplier chains for Pt-to-Pt & VSAT Radios yielding reduced parts count vs. traditional approaches.

Electrical Specifications, $T_A = +25^\circ C$, $V_{dd} = +4.5V$, +4 dBm Drive Level

Parameter	Min.	Typ.	Max.	Min.	Typ.	Max.	Units
Frequency Range, Input		12.5 - 15.0		15.0 - 15.5			GHz
Frequency Range, Output		25 - 30		30 - 31			GHz
Output Power	17	21		14	18		dBm
Fo Isolation (with respect to output level)		55		55			dBc
Input Return Loss	4	12		4	9		dB
Output Return Loss	6	12		5	10		dB
Supply Current (I _{dd1} & I _{dd2})		214	240		214	240	mA



SMT GaAs MMIC x2 ACTIVE FREQUENCY MULTIPLIER, 25 - 31 GHz OUTPUT

Output Power vs. Temperature @ +4 dBm Drive Level

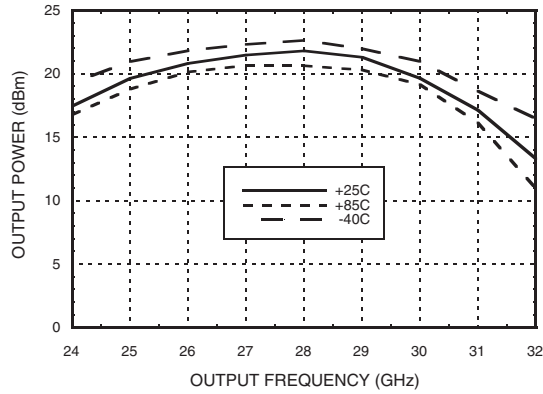

Output Power vs. Drive Level

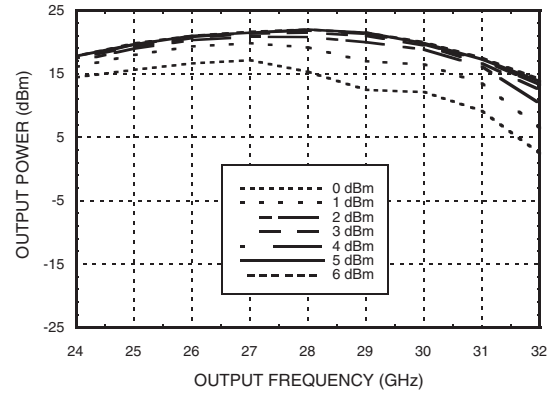

Output Power vs. Supply Voltage @ +4 dBm Drive Level

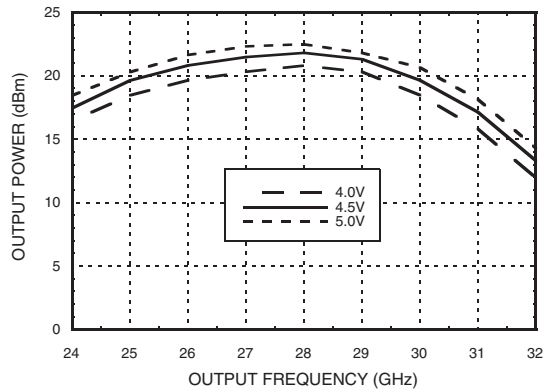

Isolation @ +4 dBm Drive Level

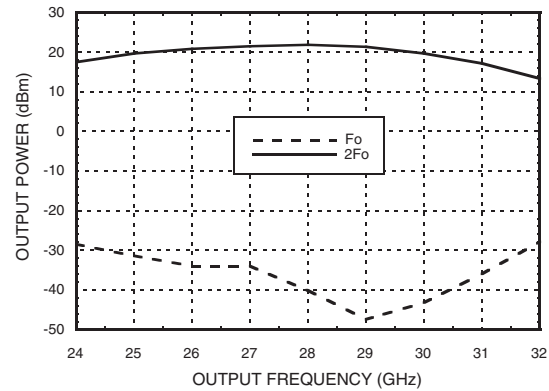

Output Power vs. Input Power

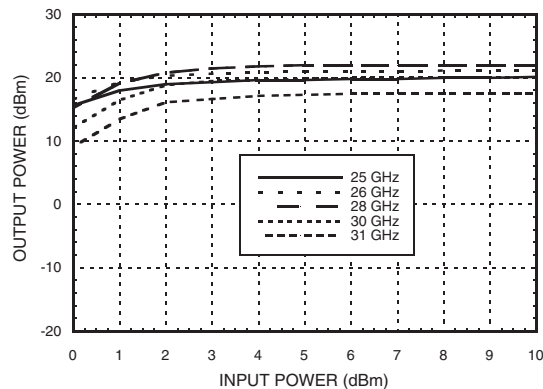



SMT GaAs MMIC x2 ACTIVE FREQUENCY MULTIPLIER, 25 - 31 GHz OUTPUT

Input Return Loss vs. Temperature

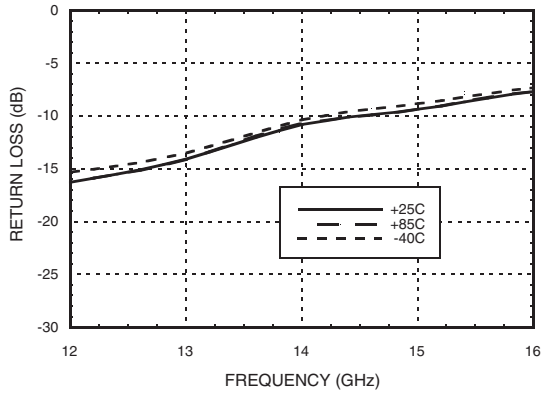

Output Return Loss vs. Temperature

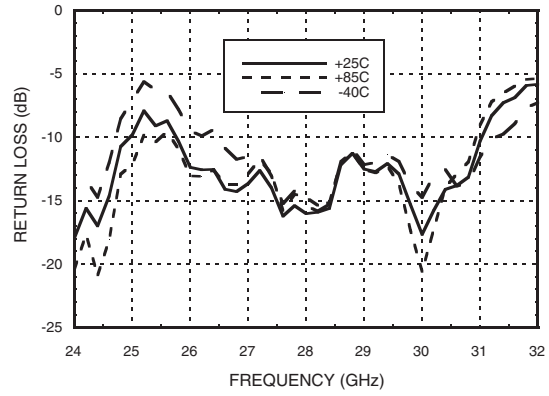

SMT GaAs MMIC x2 ACTIVE FREQUENCY MULTIPLIER, 25 - 31 GHz OUTPUT

Absolute Maximum Ratings

RF Input (Vdd = +5V)	+10 dBm
Supply Voltage (Vdd1, Vdd2)	+5.5 Vdc
Channel Temperature	175 °C
Continuous Pdiss (T= 85 °C) (derate 16.4 mW/°C above 85 °C)	1.48 W
Thermal Resistance (channel to ground paddle)	60 °C/W
Storage Temperature	-65 to +150 °C
Operating Temperature	-40 to +85 °C
ESD Sensitivity (HBM)	Class 1B

Typical Supply Current vs. Vdd

Vdd (Vdc)	Idd (mA)
4.0	211
4.5	214
5.0	217

Note:
Multiplier will operate over full voltage range shown above.



ELECTROSTATIC SENSITIVE DEVICE
OBSERVE HANDLING PRECAUTIONS

5

Outline Drawing

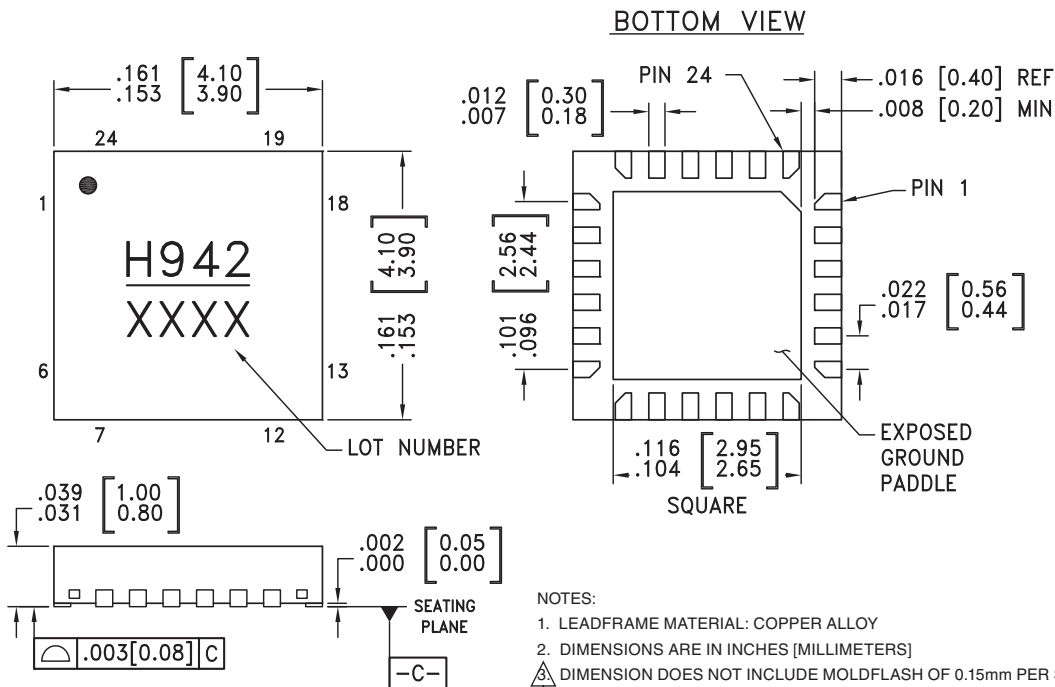

Package Information

Part Number	Package Body Material	Lead Finish	MSL Rating	Package Marking ^[1]
HMC942LP4E	RoHS-compliant Low Stress Injection Molded Plastic	100% matte Sn	MSL1 ^[2]	H942 XXXX

[1] 4-Digit lot number XXXX

[2] Max peak reflow temperature of 260 °C



SMT GaAs MMIC x2 ACTIVE FREQUENCY MULTIPLIER, 25 - 31 GHz OUTPUT

Pin Description

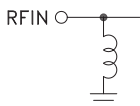
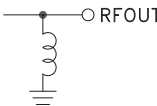
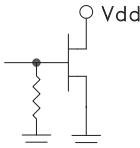
Pin Number	Function	Description	Interface Schematic
1, 3, 5, 6, 7, 12, 13, 14, 16, 18, 19, 24	GND	Package bottom must also be connected to RF/DC ground.	
4	RFIN	This pin is DC coupled and matched to 50 Ohms.	
2, 8, 9, 10, 11, 17, 20, 21, 23	N/C	These pins are not connected internally; however, all data shown herein was measured with these pins connected to RF/ DC ground.	
15	RFOUT	This pin is AC coupled and matched to 50 Ohms.	
22	Vdd	Supply voltage 4.5V ± 0.5V. External bypass capacitors of 100 pF, 1,000 pF and 2.2 µF are recommended.	

Application Circuit

Component	Value
C1	100 pF
C2	1,000 pF
C3	4.7 µF

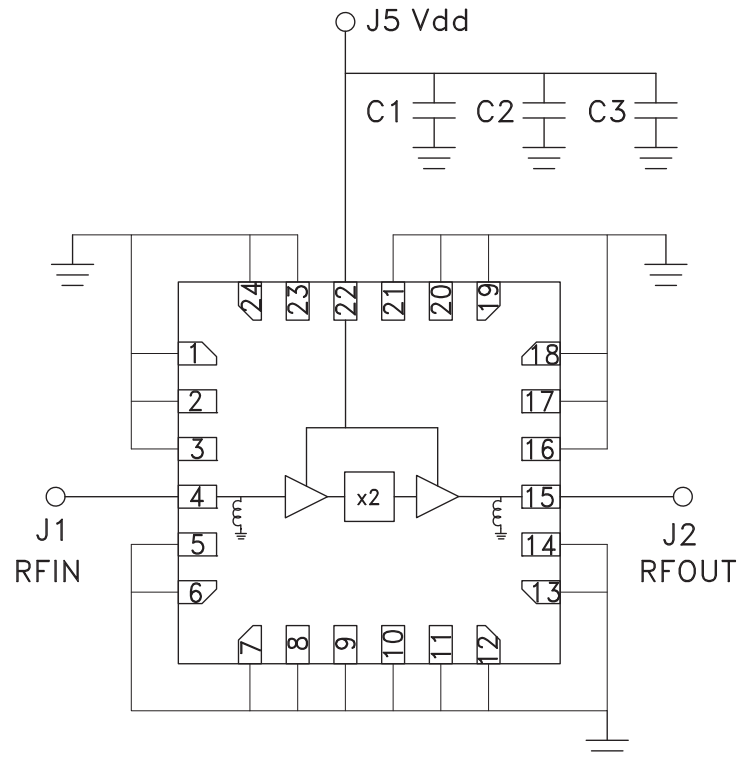

SMT GaAs MMIC x2 ACTIVE FREQUENCY MULTIPLIER, 25 - 31 GHz OUTPUT

Evaluation PCB

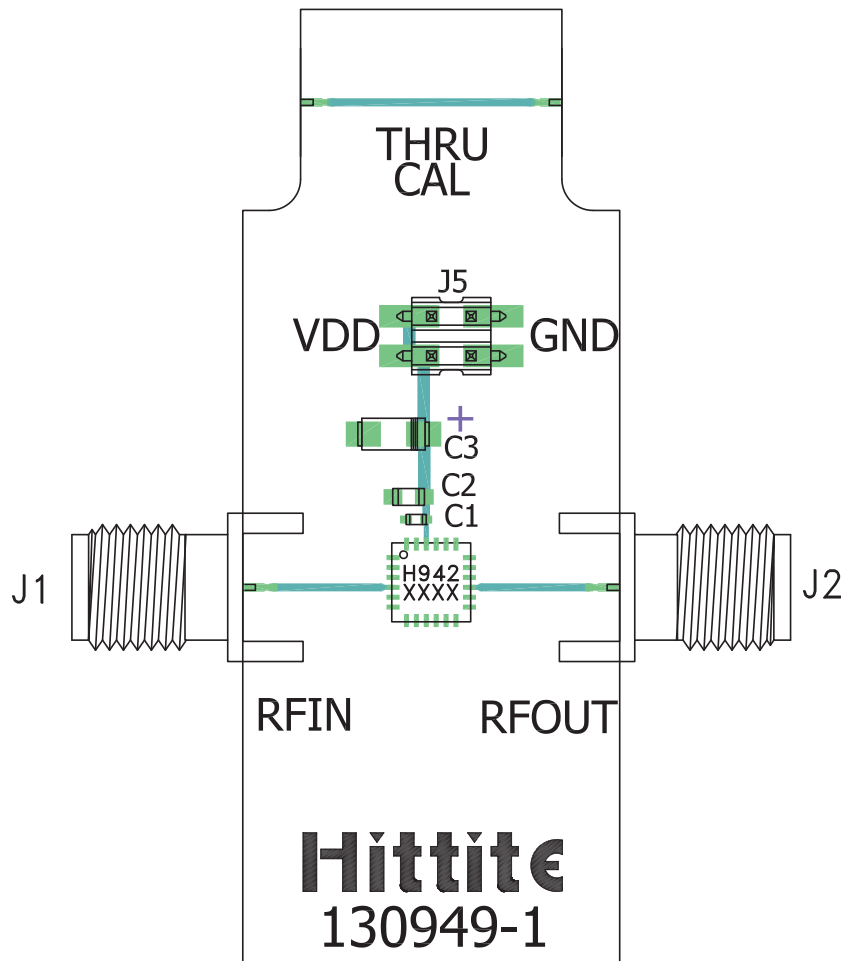

List of Materials for Evaluation PCB 130602 [1]

Item	Description
J1 - J2	PCB Mount SRI K Connector
J5	DC Pin
C1	100 pF Capacitor, 0402 Pkg.
C2	1,000 pF Capacitor, 0603 Pkg.
C3	4.7 μ F Tantalum Capacitor
U1	HMC942LP4E x2 Active Multiplier
PCB [2]	130949 Eval Board

[1] Reference this number when ordering complete evaluation PCB

[2] Circuit Board Material: Rogers 4350 or Arlon 25FR

The circuit board used in the application should be generated with proper RF circuit design techniques. Signal lines should have 50 Ohm impedance while the package ground leads and exposed paddle should be connected directly to the ground plane similar to that shown. A sufficient number of via holes should be used to connect the top and bottom ground planes. The evaluation circuit board shown is available from Hittite upon request.