



Typical Applications

The HMC-C016 Wideband LNA is ideal for:

- Telecom Infrastructure
- Microwave Radio & VSAT
- Military & Space
- Test Instrumentation
- Fiber Optics

Functional Diagram

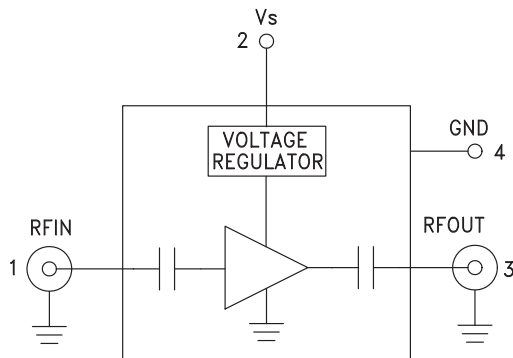

Features

Noise Figure: 2 dB @ 16 GHz

Gain: 22 dB

P1dB Output Power: +14 dBm @ 16 GHz

50 Ohm Matched Input/Output

Regulated Supply

Hermetically Sealed Module

Field Replaceable SMA Connectors

-55 to +85°C Operating Temperature

General Description

The HMC-C016 is a GaAs MMIC PHEMT Low Noise Amplifier in a miniature, hermetic module which operates between 7 and 17 GHz. This high dynamic range amplifier provides 22 dB of gain, 2 dB noise figure and up to +14 dBm of output power at 1 dB gain compression while operating from a single positive supply between +8 and +16 volts. The I/Os are internally matched to 50 Ohms and internally DC blocked for robust performance. The module features removable SMA connectors which can be detached to allow direct connection of the I/O pins to a microstrip or coplanar circuit.

Electrical Specifications, $T_A = +25^\circ\text{C}$, $V_s = +8\text{V}$ to $+16\text{V}$

Parameter	Min.	Typ.	Max.	Min.	Typ.	Max.	Min.	Typ.	Max.	Units
Frequency Range	7 - 9			9 - 13			13 - 17			GHz
Gain	17.5	20.5		19	22		18	21		dB
Gain Variation Over Temperature		0.02	0.025		0.02	0.025		0.02	0.025	dB/°C
Noise Figure		3	4.5		2.5	3		2	3.0	dB
Input Return Loss		8			10			10		dB
Output Return Loss		20			25			15		dB
Output Power for 1 dB Compression (P1dB)	8	12		11	14		11	14		dBm
Saturated Output Power (Psat)		17			18			18		dBm
Output Third Order Intercept (IP3)		24			25			25		dBm
Supply Current		93			93			93		mA



Gain & Return Loss

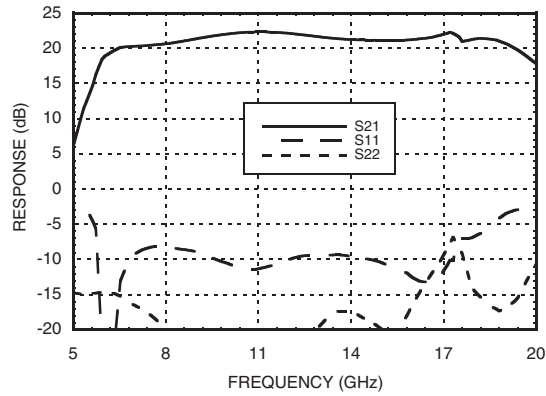

Gain vs. Temperature

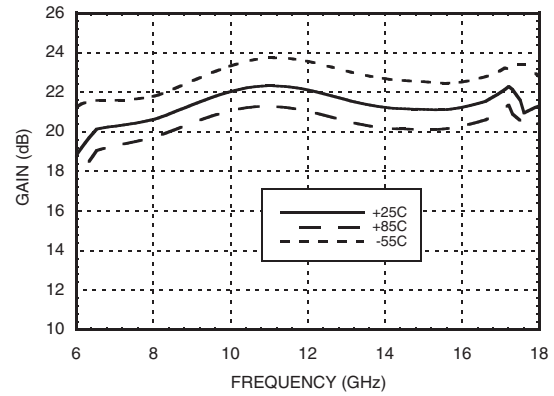

Input Return Loss vs. Temperature

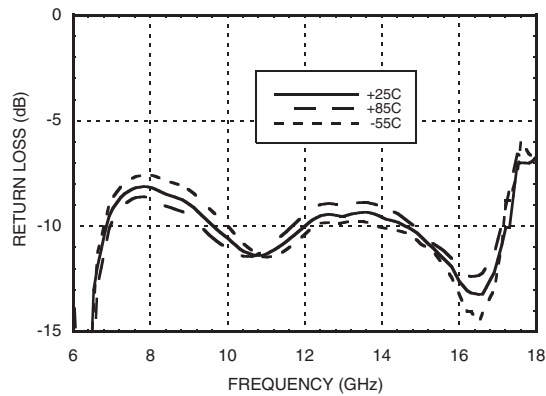

Output Return Loss vs. Temperature

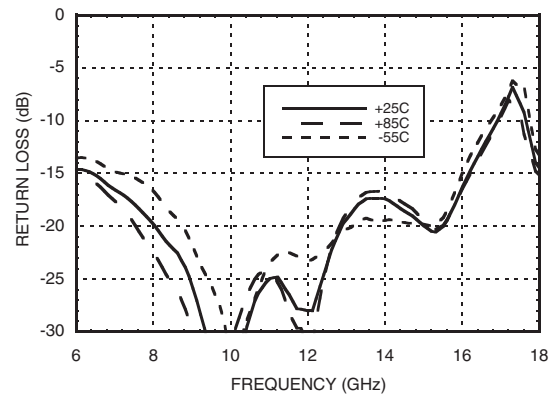

Reverse Isolation vs. Temperature

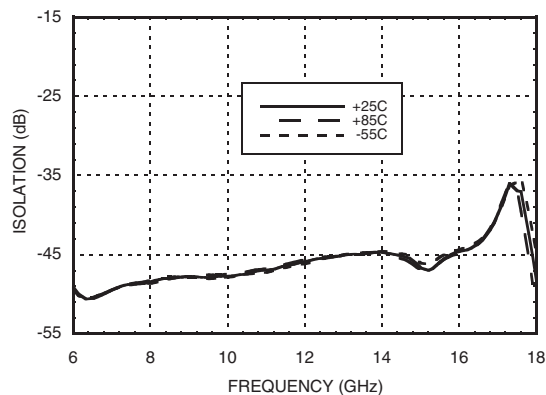

Noise Figure vs. Temperature

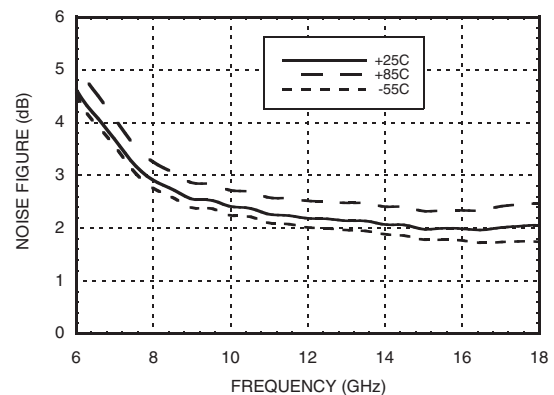



P1dB vs. Temperature

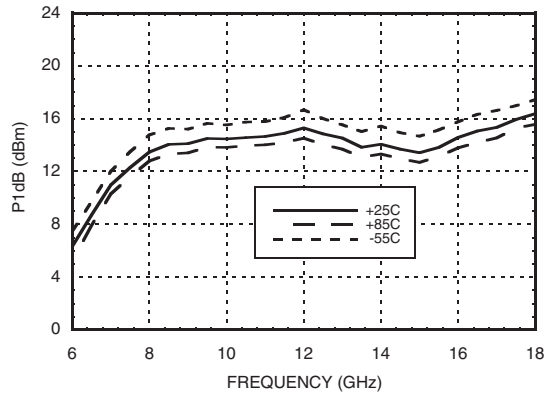

Psat vs. Temperature

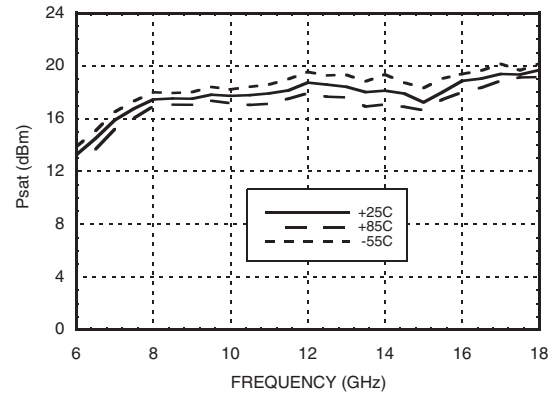

Output IP3 vs. Temperature

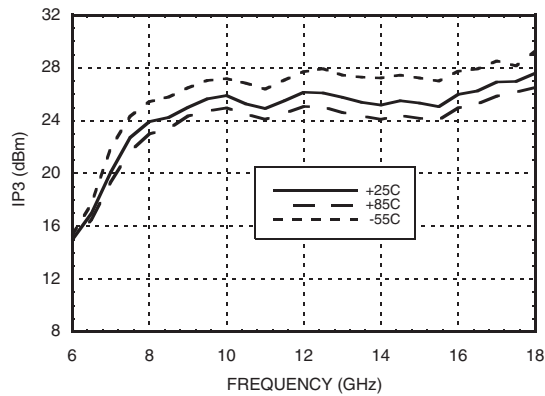

Power Compression @ 12 GHz

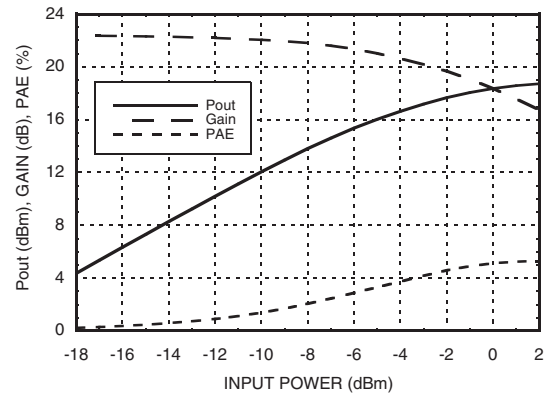

Absolute Maximum Ratings



Bias Supply Voltage (Vs)	-0.3 Vdc to +25 Vdc
RF Input Power (RFIN)	+10 dBm
Storage Temperature	-65 to +150 °C
Operating Temperature	-55 to +85 °C



ELECTROSTATIC SENSITIVE DEVICE
OBSERVE HANDLING PRECAUTIONS

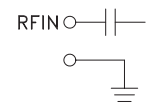
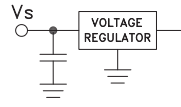
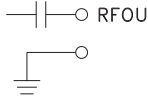

Pin Descriptions

Pin Number	Function	Description	Interface Schematic
1	RFIN & RF Ground	RF input connector, SMA female, field replaceable. This pin is AC coupled and matched to 50 Ohms.	
2	Vs	Power supply voltage for the amplifier.	
3	RFOUT & RF Ground	RF output connector, SMA female, field replaceable. This pin is AC coupled and matched to 50 Ohms.	
4	GND	Power supply ground.	



Outline Drawing

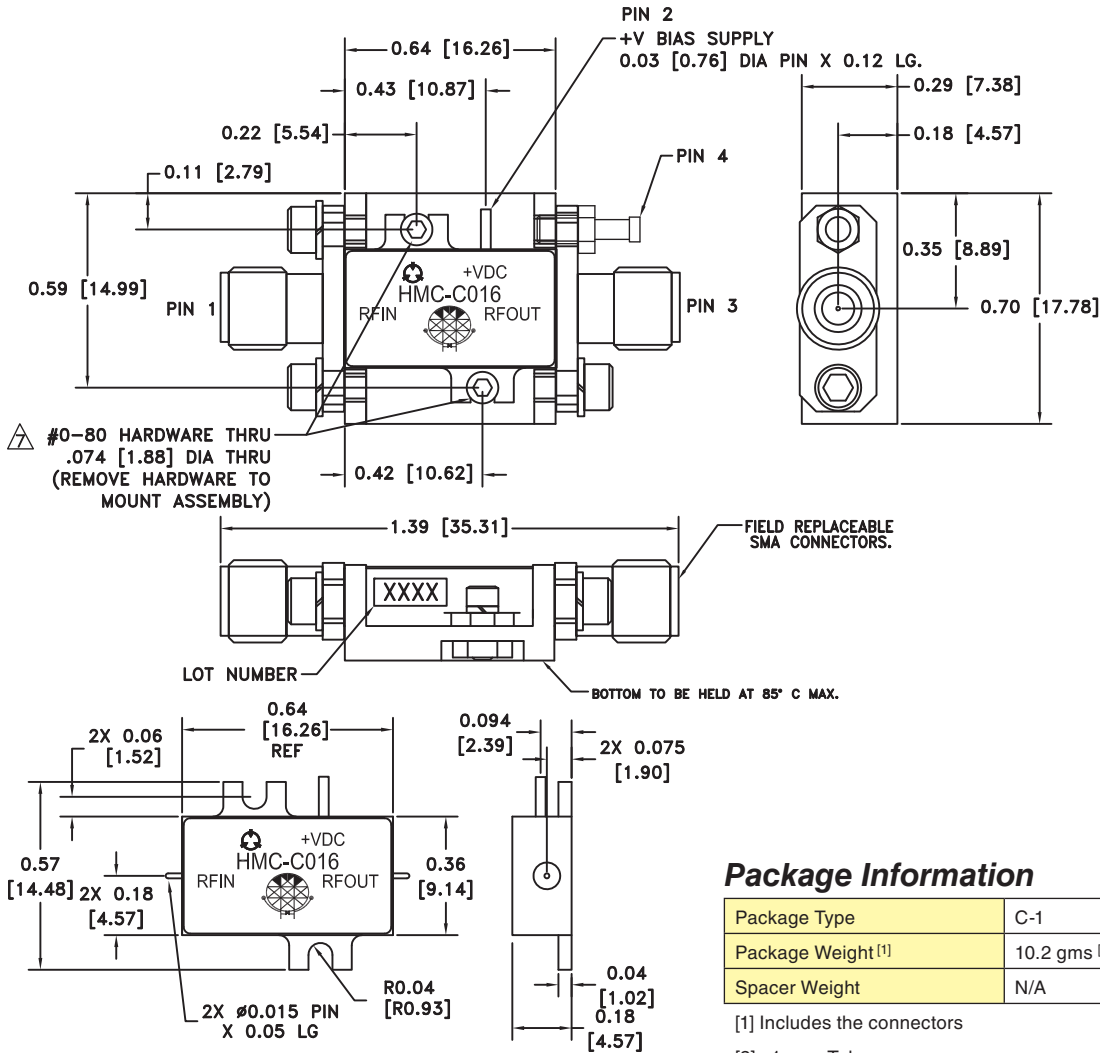

Package Information

Package Type	C-1
Package Weight ^[1]	10.2 gms ^[2]
Spacer Weight	N/A

[1] Includes the connectors

[2] ±1 gms Tolerance

NOTES:

1. PACKAGE, LEADS, COVER MATERIAL: KOVAR™
 2. SPACER MATERIAL: ALUMINUM
 3. PLATING: ELECTROLYTIC GOLD 50 MICRONS MIN., OVER ELECTROLYTIC NICKEL 75 MICRONS MIN.
 4. ALL DIMENSIONS ARE IN INCHES [MILLIMETERS].
 5. TOLERANCES ±.005 [0.13] UNLESS OTHERWISE SPECIFIED.
 6. FIELD REPLACEABLE SMA CONNECTORS.
- TENSOLITE 5602 - 5CCSF OR EQUIVALENT.

△ TO MOUNT MODULE TO SYSTEM PLATFORM REPLACE 0-80 HARDWARE WITH DESIRED MOUNTING SCREWS.



Notes: