

## WIDEBAND POWER AMPLIFIER MODULE, 17 - 24 GHz



### Typical Applications

The HMC-C020 Wideband PA is ideal for:

- Microwave Radio & VSAT
- Military & Space
- Test & Lab Instrumentation

### Functional Diagram

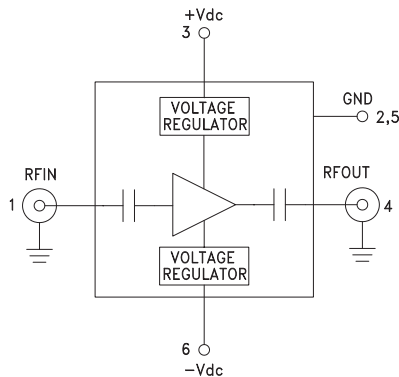

### Features

- Gain: 22 dB
- P1dB Output Power: +24 dBm
- Noise Figure: 3.5 dB
- Spurious-Free Operation
- Regulated Supply and Bias Sequencing
- Hermetically Sealed Module
- Field Replaceable 2.92mm connectors
- 55 °C to +85 °C Operating Temperature

### General Description

The HMC-C020 is a GaAs MMIC PHEMT Power Amplifier in a miniature, hermetic module with replaceable 2.92mm connectors which operates between 17 and 24 GHz. The amplifier provides 22 dB of gain, 3.5 dB noise figure, +33 dBm output IP3 and up to +24 dBm of output power at 1 dB gain compression. The wideband amplifier I/Os are internally matched to 50 Ohms and are DC blocked making the HMC-C020 ideal for EW, ECM RADAR and test equipment applications. Integrated voltage regulators allow for flexible biasing of both the negative and positive supply pins, while internal bias sequencing circuitry assures robust operation.

### Electrical Specifications, $T_A = +25^\circ \text{C}$ , $+V_{dc} = +8\text{V to } +15\text{V}$ , $-V_{dc} = -4\text{V to } -10\text{V}^*$

Parameter	Min.	Typ.	Max.	Min.	Typ.	Max.	Units
Frequency Range	17 - 20		20 - 24				GHz
Gain	19	22	24	19	22	24	dB
Gain Flatness	±1.0		±0.5				dB
Gain Variation Over Temperature	-0.03		-0.04				dB/ °C
Noise Figure	3.5		5.5				dB
Input Return Loss	7		7				dB
Output Return Loss	10		10				dB
Output Power for 1 dB Compression (P1dB)	20	23	20		24	dBm	
Saturated Output Power (P <sub>sat</sub> )	25		26				dBm
Output Third Order Intercept (IP3)	33		33				dBm
Positive Supply Current (+IDC)	250		250				mA
Negative Supply Current (-IDC)	5.2		5.2				mA

\* Data recorded at  $+V_{dc} = +12\text{V}$  and  $-V_{dc} = -5\text{V}$

For price, delivery, and to place orders, please contact Hittite Microwave Corporation:  
20 Alpha Road Chelmsford, MA 01824 Phone: 978-250-3343 Fax: 978-250-3373  
Order Online at [www.hittite.com](http://www.hittite.com)

## WIDEBAND POWER AMPLIFIER MODULE, 17 - 24 GHz

**Gain & Return Loss**

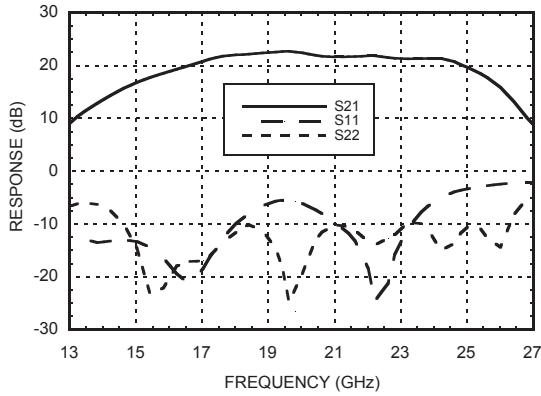

**Gain vs. Temperature**

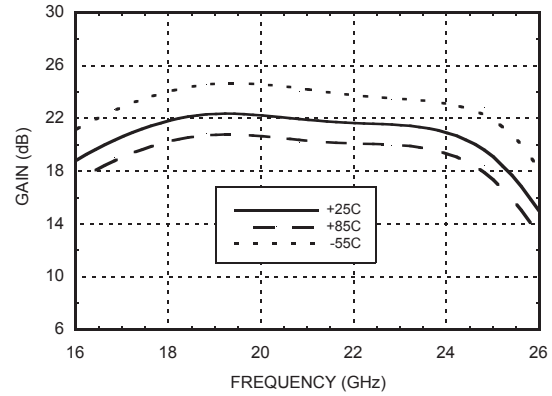

**Input Return Loss vs. Temperature**

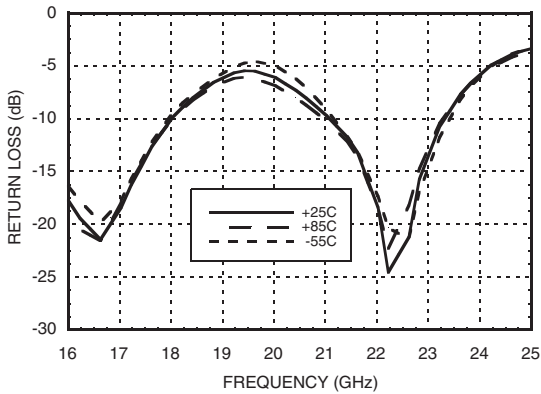

**Output Return Loss vs. Temperature**

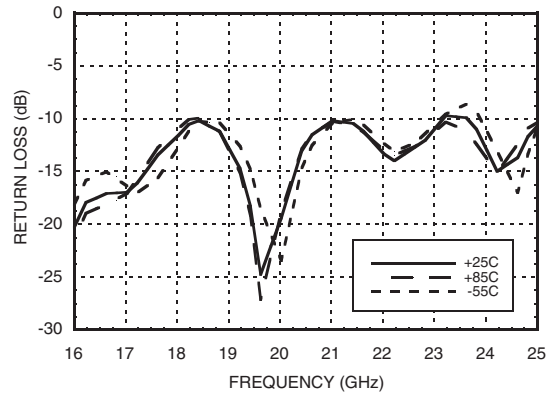

**Reverse Isolation vs. Temperature**

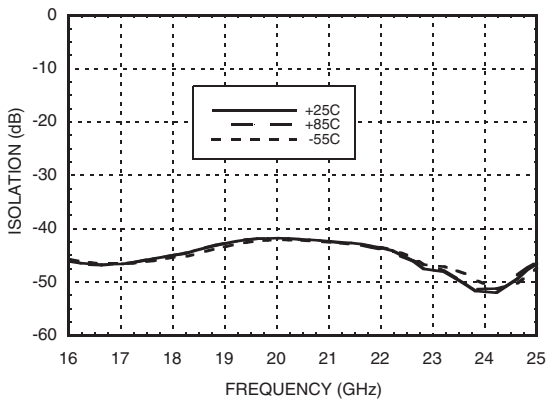

**Noise Figure vs. Temperature**

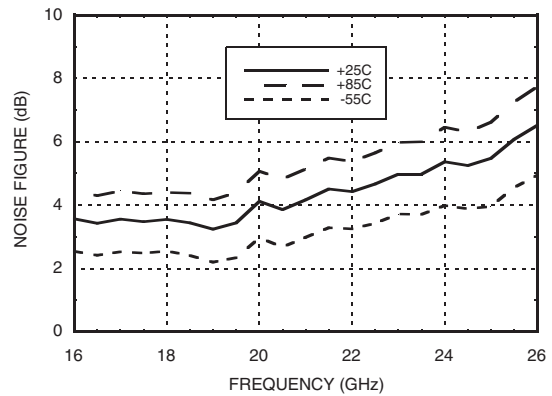



## WIDEBAND POWER AMPLIFIER MODULE, 17 - 24 GHz

**P1dB vs. Temperature**

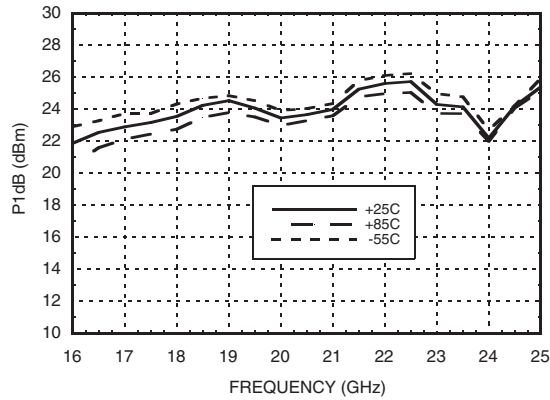

**Psat vs. Temperature**

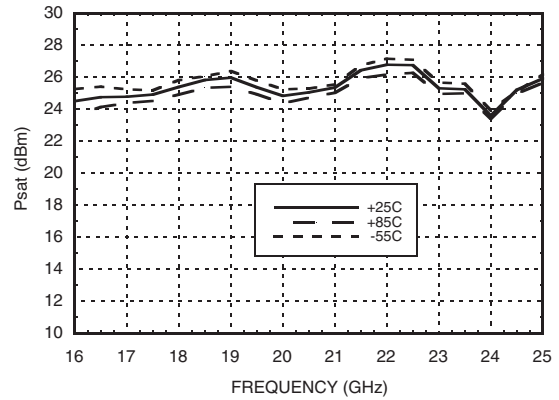

**Output IP3 vs. Temperature**

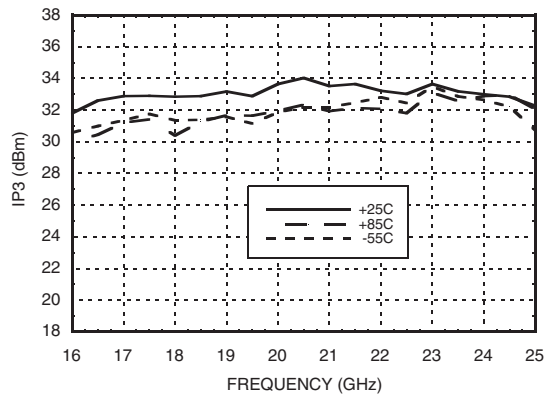

**Absolute Maximum Ratings**



Positive Bias Supply Voltage (+Vdc)	+17V Max
Negative Bias Supply (-Vdc)	-16V Min.
RF Input Power (RFIN)	+20 dBm
Storage Temperature	-65 to +150 °C
Operating Temperature	-55 to +85 °C



**ELECTROSTATIC SENSITIVE DEVICE  
OBSERVE HANDLING PRECAUTIONS**

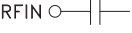

**Pin Descriptions**

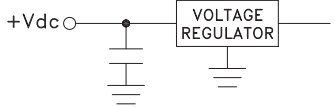
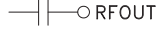
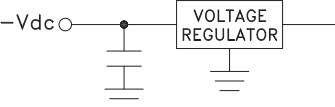
Pin Number	Function	Description	Interface Schematic
1	RFIN	RF input connector, 2.92mm female, field replaceable. This pin is AC coupled and matched to 50 Ohms.	
2, 5	GND	Power supply ground.	
3	+Vdc	Positive power supply voltage for the amplifier.	
4	RFOUT	RF output connector, 2.92mm female. This pin is AC coupled and matched to 50 Ohms.	
6	-Vdc	Negative power supply voltage for the amplifier	

## WIDEBAND POWER AMPLIFIER MODULE, 17 - 24 GHz



### Outline Drawing

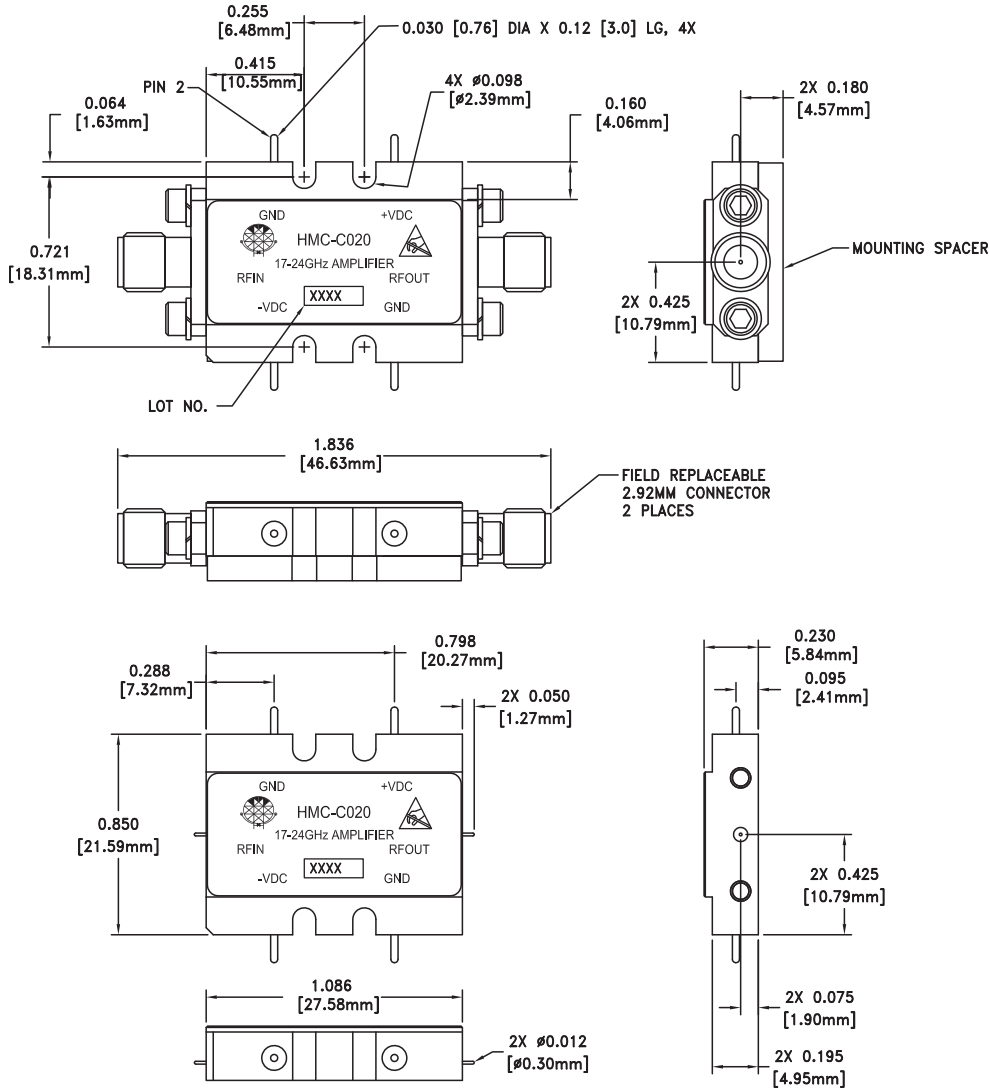

VIEW SHOWN WITH CONNECTORS REMOVED

### Package Information

Package Type	C-10
Package Weight [1]	18.7 gms [2]
Spacer Weight	3.3 gms [2]

[1] Includes the connectors

[2]  $\pm$ 1 gms Tolerance

### NOTES:

1. PACKAGE, LEADS, COVER MATERIAL: KOVAR™
2. FINISH: GOLD PLATE OVER NICKEL PLATE
3. ALL DIMENSIONS ARE IN INCHES [MILLIMETERS]
4. TOLERANCES:
  - 4.1 .XX =  $\pm$ 0.02
  - 4.2 .XXX =  $\pm$ 0.010
5. FIELD REPLACEABLE 2.92mm CONNECTORS TENSOLITE 231CCSF OR EQUIVALENT



MICROWAVE CORPORATION v03.0310



**HMC-C020**

**WIDEBAND POWER AMPLIFIER  
MODULE, 17 - 24 GHz**

**Notes:**