

WIDEBAND DRIVER AMPLIFIER MODULE, 10 MHz - 20 GHz



Typical Applications

The HMC-C024 Wideband Driver is ideal for:

- OC192 LN/MZ Modulator Driver
- Telecom Infrastructure
- Microwave Radio & VSAT
- Military & Space
- Test Instrumentation

Functional Diagram

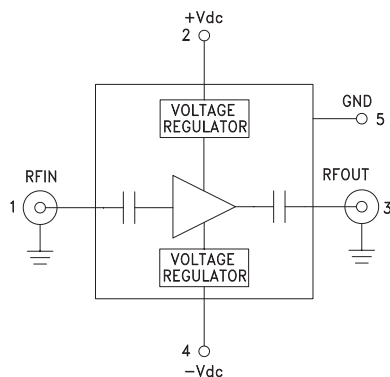

Features

- Gain: 15 dB
- Saturated Output Power: +24 dBm
- Spurious-Free Operation
- Regulated Supply and Bias Sequencing
- Hermetically Sealed Module
- Field Replaceable SMA connectors
- 55 to +85°C Operating Temperature

General Description

The HMC-C024 is a GaAs MMIC PHEMT Distributed Driver Amplifier in a miniature, hermetic module with replaceable SMA connectors which operates between 10 MHz and 20 GHz. The amplifier provides 15 dB of gain, 3 to 4 dB noise figure and +24 dBm of saturated output power. Deviation from linear phase of only ± 2 degrees from 0.01 to 10 GHz make the HMC-C024 ideal for OC192 fiber optic LN/MZ modulator driver applications. The wideband amplifier I/Os are internally matched to 50 Ohms and are internally DC blocked. Integrated voltage regulators allow for flexible biasing of both the negative and positive supply pins, while internal bias sequencing circuitry assures robust operation.

Electrical Specifications, $T_A = +25^\circ \text{C}$, +Vdc = +11V to +16V, -Vdc = -3V to -12V

Parameter	Min.	Typ.	Max.	Min.	Typ.	Max.	Min.	Typ.	Max.	Units
Frequency Range	0.010 - 6.0		6.0 - 12.0		12.0 - 20.0					GHz
Gain	14	16		13	15		10	13		dB
Gain Flatness		± 0.75			± 0.75			± 1.0		dB
Gain Variation Over Temperature		0.018	0.025		0.018	0.025		0.018	0.025	dB/°C
Noise Figure		3.5			3			4		dB
Input Return Loss		19			17			10		dB
Output Return Loss		14			14			12		dB
Output Power for 1 dB Compression (P1dB)	20	24		19	23		17	20		dBm
Saturated Output Power (P _{sat})		26			25			22		dBm
Output Third Order Intercept (IP3)		33			30			25		dBm
Saturated Output Voltage		10			10			8		V _{pk-pk}
Group Delay		± 3			± 3			± 3		ps
Positive Supply Current (+IDC)		225			225			225		mA
Negative Supply Current (-IDC)		1.6			1.6			1.6		mA

For price, delivery, and to place orders, please contact Hittite Microwave Corporation:
20 Alpha Road Chelmsford, MA 01824 Phone: 978-250-3343 Fax: 978-250-3373
Order Online at www.hittite.com

WIDEBAND DRIVER AMPLIFIER MODULE, 10 MHz - 20 GHz

Gain & Return Loss

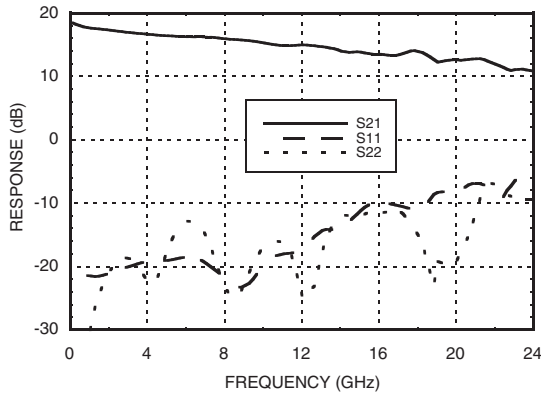

Gain vs. Temperature

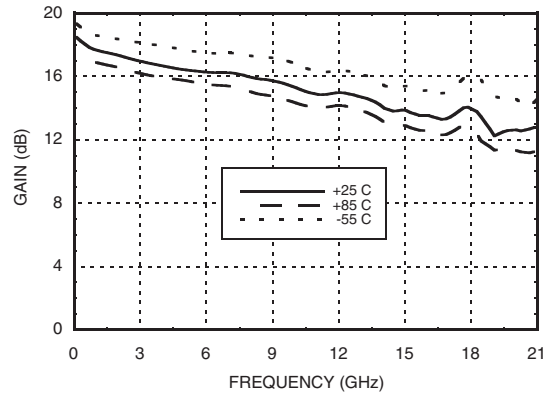

Input Return Loss vs. Temperature

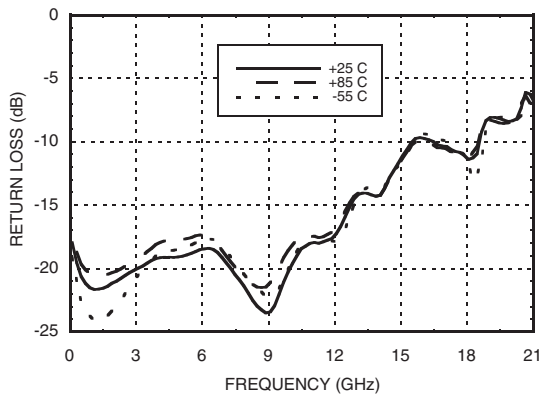

Output Return Loss vs. Temperature

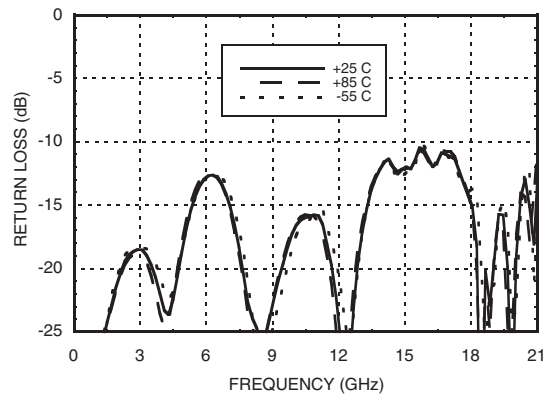

Reverse Isolation vs. Temperature

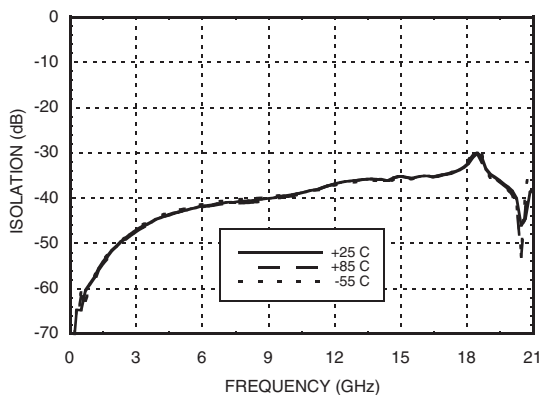

Noise Figure vs. Temperature

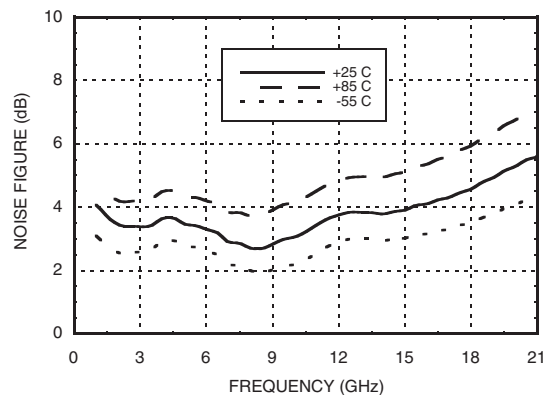

WIDEBAND DRIVER AMPLIFIER MODULE, 10 MHz - 20 GHz

P1dB vs. Temperature

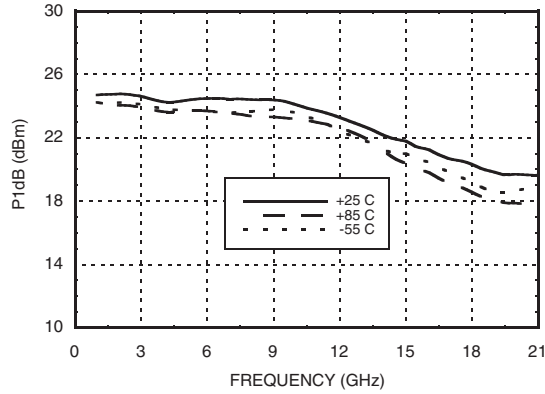

Psat vs. Temperature

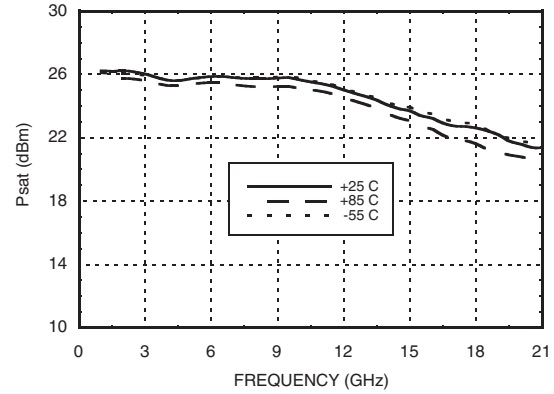

Output IP3 vs. Temperature

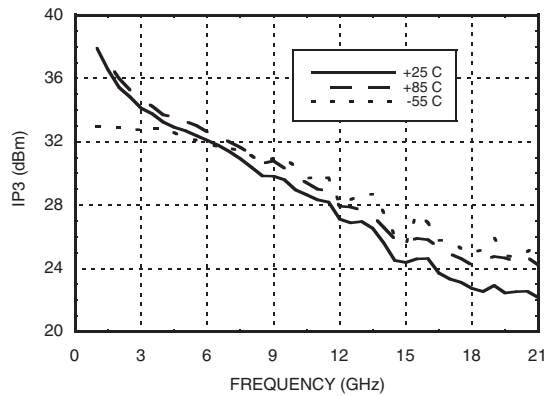

Group Delay

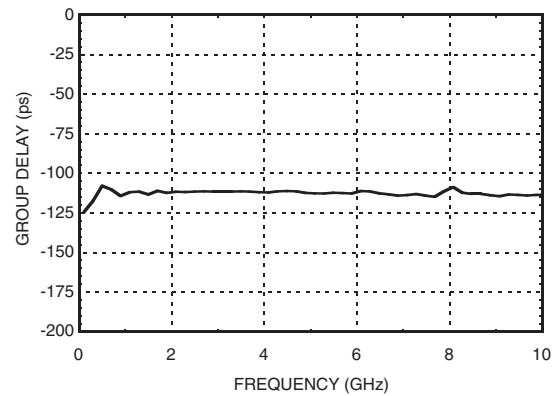

Deviation from Linear Phase

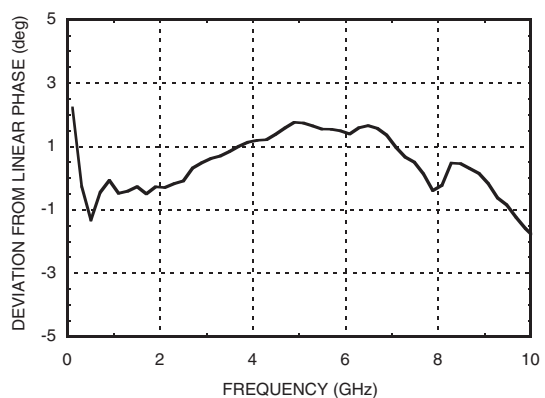

Low Frequency Gain and Return Loss

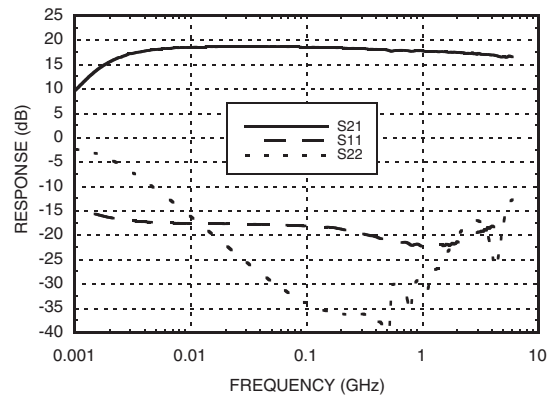

WIDEBAND DRIVER AMPLIFIER MODULE, 10 MHz - 20 GHz

Input OC-192 Eye Diagram ^{[1][2]}

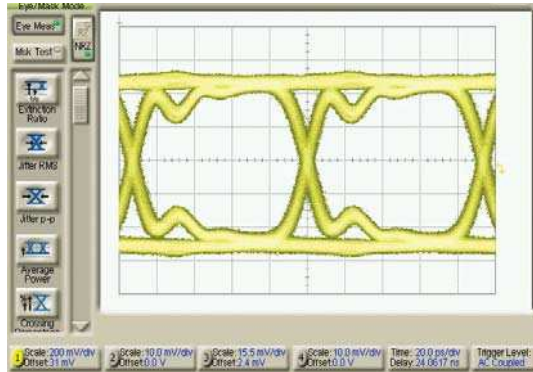

Output OC-192 Eye Diagram ^{[1][3]}

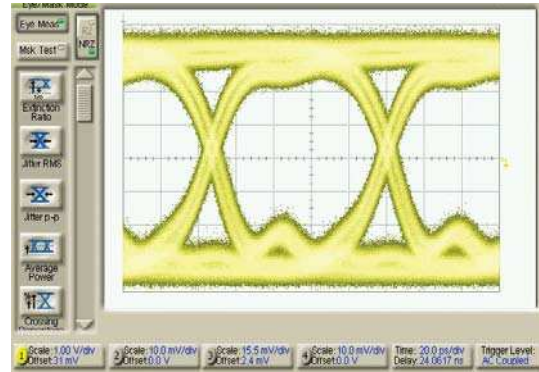

[1] Test Conditions:

Pattern generated with an Agilent N4901B Serial BERT
 Eye diagram data presented on an infiniium DCA 86100A.
 Rate = 10.709 GB/s
 Pseudo Random Code = 2²³-1

[2] Vertical Scale = 200 mV/Div.

[3] Vertical Scale = 1 V/Div.

Absolute Maximum Ratings

Positive Bias Supply Voltage (+Vdc)	+17V Max
Negative Bias Supply (-Vdc)	-16V Min.
RF Input Power (RFIN)	+23 dBm
Storage Temperature	-65 to +150 °C
Operating Temperature	-55 to +85 °C





**ELECTROSTATIC SENSITIVE DEVICE
OBSERVE HANDLING PRECAUTIONS**

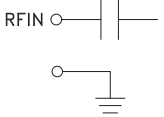
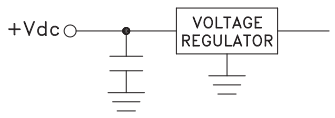
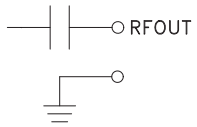
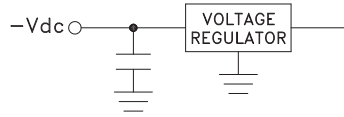

**WIDEBAND DRIVER AMPLIFIER
MODULE, 10 MHz - 20 GHz**

Pin Descriptions

Pin Number	Function	Description	Interface Schematic
1	RFIN & RF Ground	RF input connector, SMA female, field replaceable. This pin is AC coupled and matched to 50 Ohms.	
2	+Vdc	Positive power supply voltage for the amplifier.	
3	RFOUT & RF Ground	RF output connector, SMA female. This pin is AC coupled and matched to 50 Ohms.	
4	-Vdc	Negative power supply voltage for the amplifier	
5	GND	Power supply ground.	



Outline Drawing

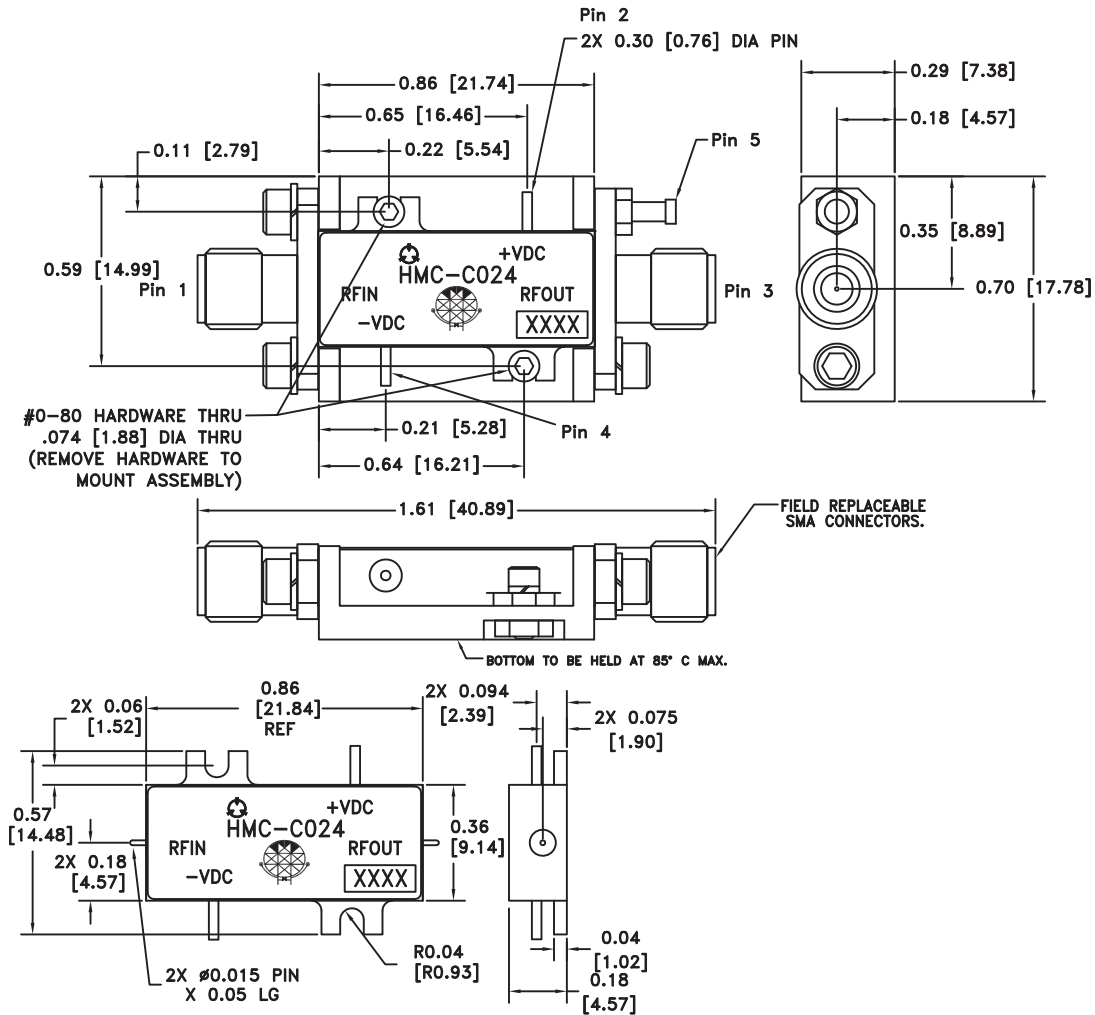

Package Information

Package Type	C-3B
Package Weight [1]	12 gms [2]
Spacer Weight	N/A

[1] Includes the connectors

[2] ±1 gms Tolerance

NOTES:

1. PACKAGE, LEADS, COVER MATERIAL: KOVAR™
2. SPACER MATERIAL: ALUMINUM
3. PLATING: ELECTROLYTIC GOLD 50 MICROINCHES MIN., OVER ELECTROLYTIC NICKEL 75 MICROINCHES MIN.
4. ALL DIMENSIONS ARE IN INCHES [MILLIMETERS].
5. TOLERANCES ±.005 [0.13] UNLESS OTHERWISE SPECIFIED.
6. FIELD REPLACEABLE SMA CONNECTORS.

TENSOLITE 5602 - 5CCSF OR EQUIVALENT.
 TO MOUNT MODULE TO SYSTEM PLATFORM REPLACE 0-80 HARDWARE WITH DESIRED MOUNTING SCREWS.