

WIDEBAND HIGH GAIN POWER AMPLIFIER MODULE, 2 - 20 GHz

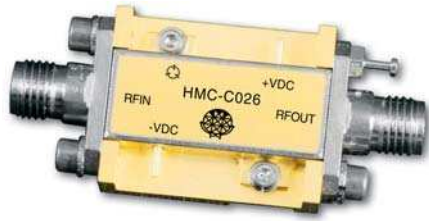

Typical Applications

The HMC-C026 Wideband PA is ideal for:

- Telecom Infrastructure
- Microwave Radio & VSAT
- Military & Space
- Test Instrumentation
- Fiber Optics

Functional Diagram

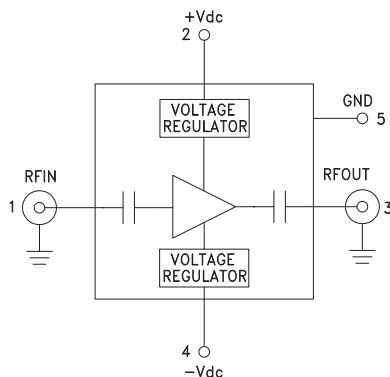

Features

- Gain: 31 dB @ 6 GHz
- P1dB Output Power: +26 dBm @ 6 GHz
- Noise Figure: 2.5 dB @ 8 GHz
- Spurious-Free Operation
- Regulated Supply and Bias Sequencing
- Hermetically Sealed Module
- Field Replaceable SMA connectors
- 55 °C to +85 °C Operating Temperature

General Description

The HMC-C026 is a GaAs MMIC pHEMT Distributed Power Amplifier in a miniature, hermetic module with replaceable SMA connectors which operates between 2 and 20 GHz. The amplifier provides 31 dB of gain, 2.5 dB noise figure, +30 dBm output IP3 and up to +26 dBm of output power at 1 dB gain compression. The wideband amplifier I/Os are internally matched to 50 Ohms and are DC blocked making the HMC-C026 ideal for EW, ECM RADAR and test equipment applications. Integrated voltage regulators allow for flexible biasing of both the negative and positive supply pins, while internal bias sequencing circuitry assures robust operation.

Electrical Specifications, $T_A = +25^\circ\text{C}$, $+V_{dc} = +11\text{V}$ to $+16\text{V}$, $-V_{dc} = -3\text{V}$ to -12V

Parameter	Min.	Typ.	Max.	Min.	Typ.	Max.	Min.	Typ.	Max.	Min.	Typ.	Max.	Units
Frequency Range	2 - 6			6 - 12			12 - 16			16 - 20			GHz
Gain	28	31		26	29		24	27		19	22		dB
Gain Flatness		±0.25			±0.75			±1.0			±2.0		dB
Gain Variation Over Temperature		0.03	0.04		0.03	0.04		0.03	0.04		0.03	0.04	dB/°C
Noise Figure		3.0	5.0		2.5	3.5		3.0	4.0		3.5	5.0	dB
Input Return Loss		15			15			13			10		dB
Output Return Loss		15			15			10			8		dB
Output Power for 1 dB Compression (P1dB)	23	26		22.5	25.5		20	24		18	21		dBm
Saturated Output Power (P _{sat})		27.5			27			25			23		dBm
Output Third Order Intercept (IP3)		33			30			27			24		dBm
Positive Supply Current (+IDC)		400	450		400	450		400	450		400	450	mA
Negative Supply Current (-IDC)		3.2	5		3.2	5		3.2	5		3.2	5	mA

For price, delivery, and to place orders, please contact Hittite Microwave Corporation:
20 Alpha Road Chelmsford, MA 01824 Phone: 978-250-3343 Fax: 978-250-3373
Order Online at www.hittite.com



WIDEBAND HIGH GAIN POWER AMPLIFIER MODULE, 2 - 20 GHz

Gain & Return Loss

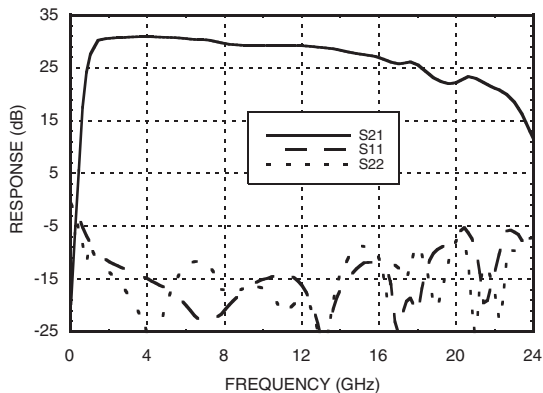

Gain vs. Temperature

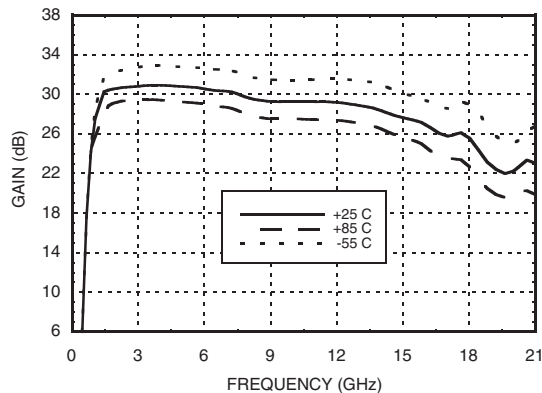

Input Return Loss vs. Temperature

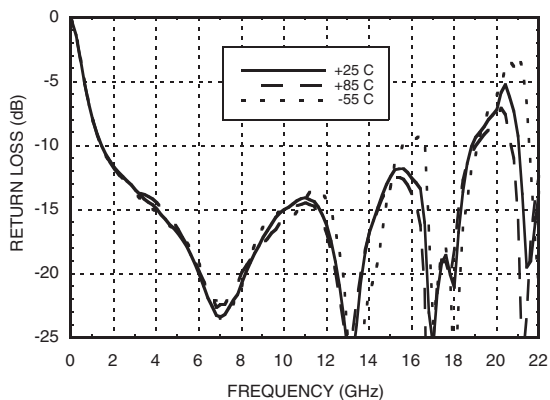

Output Return Loss vs. Temperature

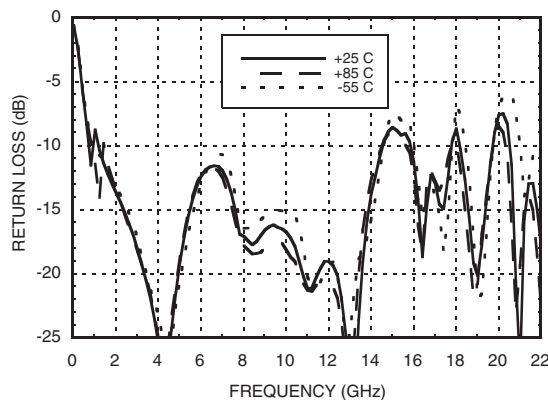

Reverse Isolation vs. Temperature

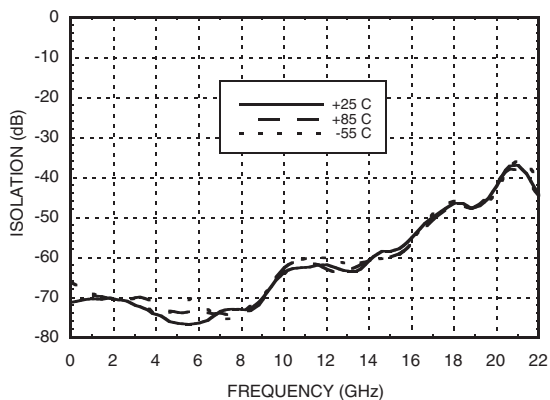

Noise Figure vs. Temperature

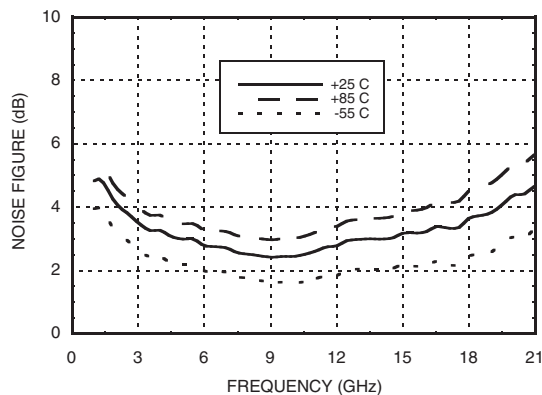



**WIDEBAND HIGH GAIN POWER AMPLIFIER
MODULE, 2 - 20 GHz**

P1dB vs. Temperature

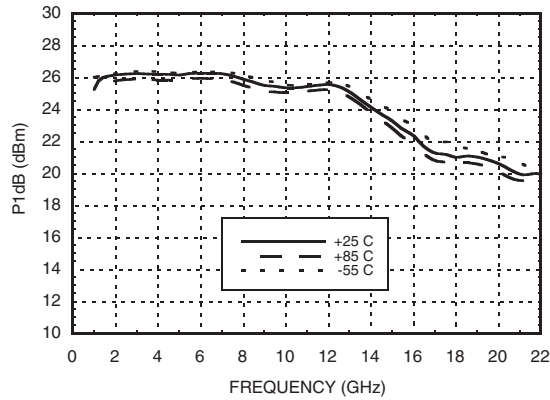

Psat vs. Temperature

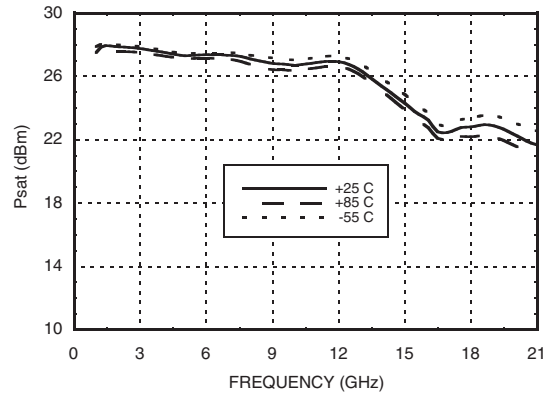

Output IP3 vs. Temperature

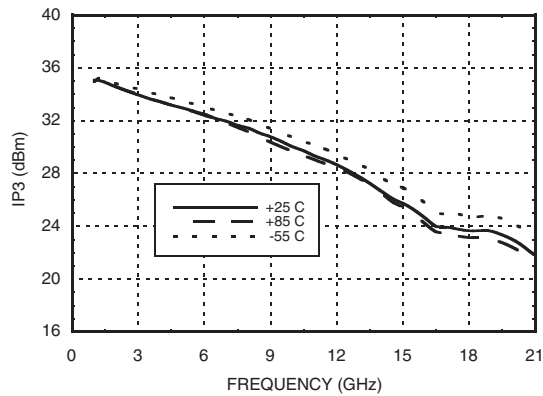

Absolute Maximum Ratings



RF Input Power (RFIN)	+23 dBm
Positive Bias Supply Voltage (+Vdc)	+17V Max
Negative Bias Supply (-Vdc)	-16V Min.
Thermal Resistance (at +Vdc = 12V, -Vdc = -4V, DC Power = 4.8 Watts)	15.9 °C/W
Storage Temperature	-65 to +150 °C
Operating Temperature	-55 to +85 °C



**ELECTROSTATIC SENSITIVE DEVICE
OBSERVE HANDLING PRECAUTIONS**

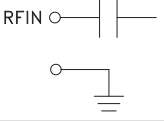
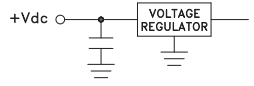
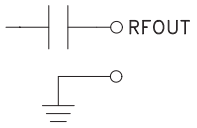
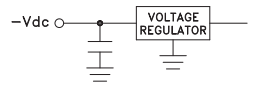

Pin Descriptions

Pin Number	Function	Description	Interface Schematic
1	RFIN & RF Ground	RF input connector, SMA female, field replaceable. This pin is AC coupled and matched to 50 Ohms.	
2	+Vdc	Positive power supply voltage for the amplifier.	
3	RFOUT & RF Ground	RF output connector, SMA female. This pin is AC coupled and matched to 50 Ohms.	
4	-Vdc	Negative power supply voltage for the amplifier	
5	GND	Power supply ground.	



Outline Drawing

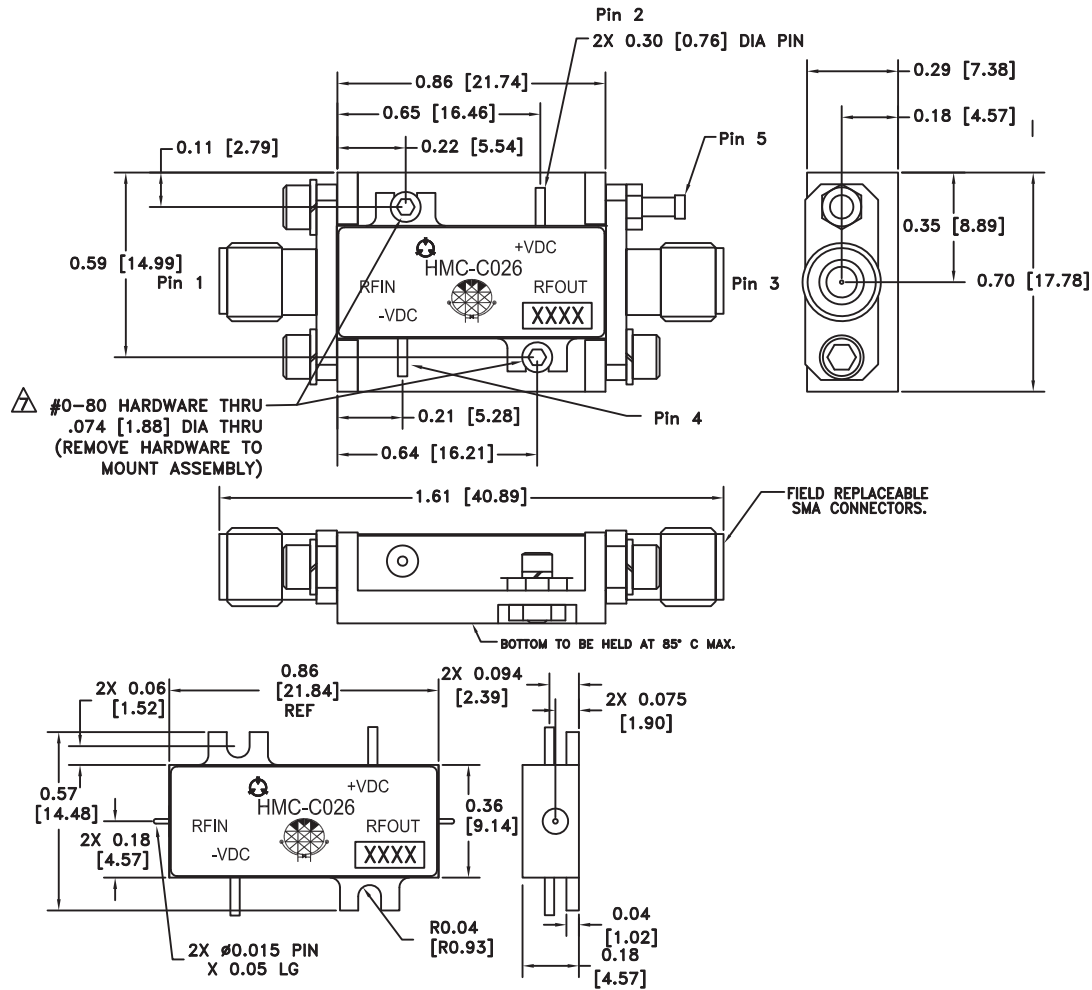

Package Information

Package Type	C-3B
Package Weight ^[1]	12 gms ^[2]
Spacer Weight	N/A

[1] Includes the connectors

[2] ±1 gms Tolerance

NOTES:

1. PACKAGE, LEADS, COVER MATERIAL: KOVAR™
2. SPACER MATERIAL: ALUMINUM
3. PLATING: ELECTROLYTIC GOLD 50 MICROINCHES MIN., OVER ELECTROLYTIC NICKEL 75 MICROINCHES MIN.
4. ALL DIMENSIONS ARE IN INCHES [MILLIMETERS].
5. TOLERANCES ±.005 [0.13] UNLESS OTHERWISE SPECIFIED.
6. FIELD REPLACEABLE SMA CONNECTORS. TENSOLITE 5602 - 5CCSF OR EQUIVALENT.

⚠ TO MOUNT MODULE TO SYSTEM PLATFORM REPLACE 0-80 HARDWARE WITH DESIRED MOUNTING SCREWS.



Notes: