



### Typical Applications

The HMC-C030 VCO Module is ideal for:

- Industrial/Medical Equipment
- Test & Measurement Equipment
- Military Radar, EW & ECM
- Lab Instrumentation

### Functional Diagram

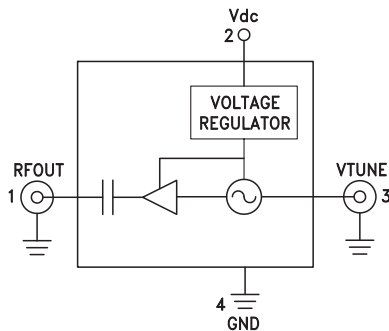

### Features

- Wide Tuning Bandwidth
- High Output Power: +21 dBm
- SSB Phase Noise: -83 dBc/Hz @100 kHz
- No External Resonator Needed
- Single Positive Supply: +8V to +15V @ 195 mA
- RoHS Compliant Hermetically Sealed Module
- Field Replaceable SMA Connectors
- 40°C to +85°C Operating Temperature

### General Description

The HMC-C030 is a wideband GaAs InGaP Voltage Controlled Oscillator which incorporates the resonator, negative resistance device, and varactor diode. An internal voltage regulator provides excellent 0.2 MHz/V frequency pushing while the output buffer amplifier boosts output power to +20 dBm; which is enough to drive one or two mixers. Phase noise performance is stable over temperature due to the oscillator's monolithic construction. The Vtune port accepts an analog tuning voltage from 0 to +13V. The HMC-C030 VCO operates from a single +8V to +15V supply, and is housed in a hermetically sealed module. This wideband VCO uniquely combines the attributes of small size, low phase noise, wide tuning range and high output power.

### Electrical Specifications, $T_A = +25^\circ\text{C}$ , $V_{dc} = +12\text{V}$

Parameter	Min.	Typ.	Max.	Units
Frequency Range	8.0 - 12.5			GHz
Power Output	18	21		dBm
SSB Phase Noise @ 100 kHz Offset		-83		dBc/Hz
SSB Phase Noise @ 10 kHz Offset		-59		dBc/Hz
Tune Voltage (Vtune)	0		13	V
Supply Current (I <sub>dc</sub> ) (V <sub>dc</sub> = +12V)		195		mA
Tune Port Leakage Current (Vtune = +15V)			10	μA
Output Return Loss		15		dB
2nd Harmonic		-20		dBc
Pulling (into a 2.0:1 VSWR)		2		MHz pp
Pushing @ Vtune = +5V		0.2		MHz/V
Frequency Drift Rate		0.8		MHz/°C

For price, delivery, and to place orders, please contact Hittite Microwave Corporation:  
20 Alpha Road Chelmsford, MA 01824 Phone: 978-250-3343 Fax: 978-250-3373  
Order Online at [www.hittite.com](http://www.hittite.com)



## WIDEBAND VCO w/ BUFFER AMPLIFIER MODULE, 8.0 - 12.5 GHz

**Frequency vs. Tuning Voltage, Vdc = +12V**

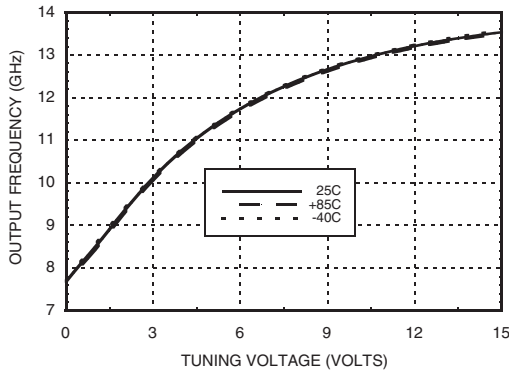

**Frequency vs. Tuning Voltage, T = +25°C**

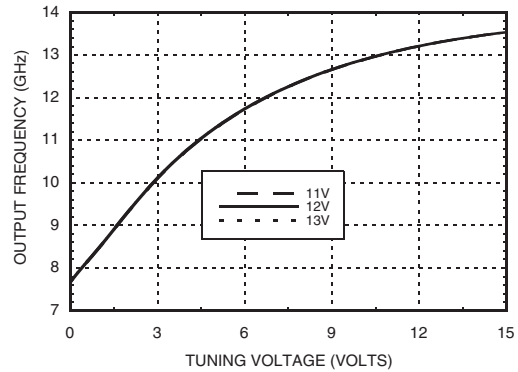

**Sensitivity vs. Tuning Voltage, Vcc = +12V**

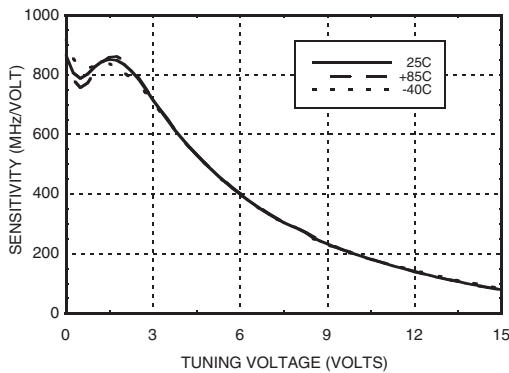

**Output Power vs. Tuning Voltage, Vcc = +12V**

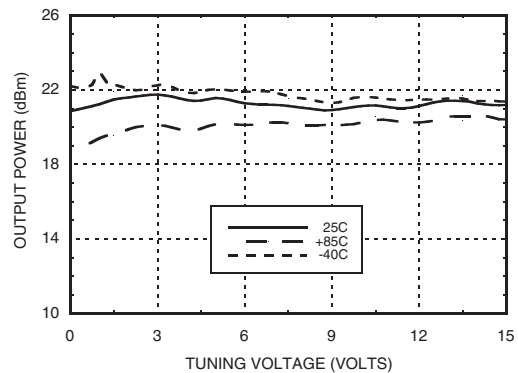

**SSB Phase Noise vs. Tuning Voltage**

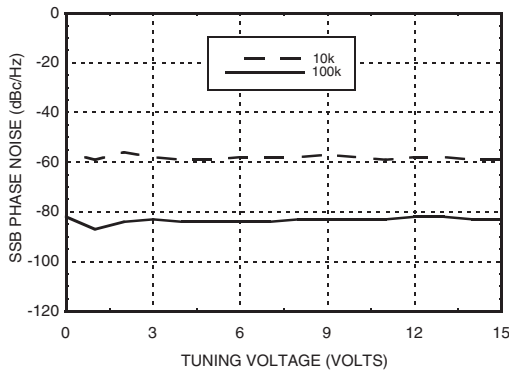

**Typical SSB Phase Noise @ Vtune = +12V**

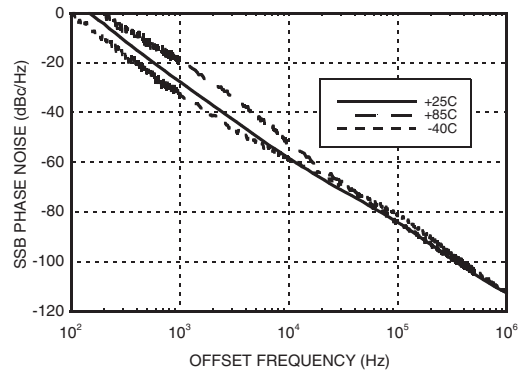

## WIDEBAND VCO w/ BUFFER AMPLIFIER MODULE, 8.0 - 12.5 GHz

### Outline Drawing

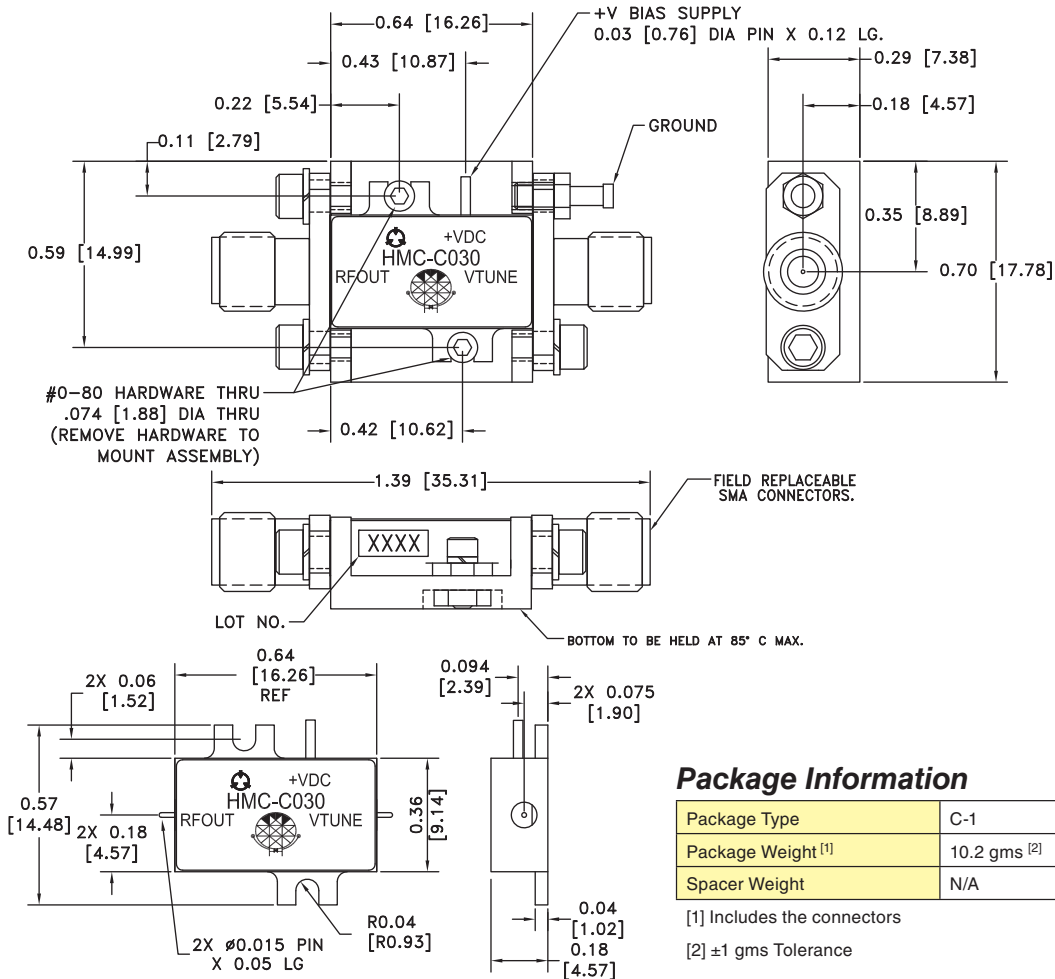

### Package Information

Package Type	C-1
Package Weight [1]	10.2 gms [2]
Spacer Weight	N/A

[1] Includes the connectors

[2] ±1 gms Tolerance

#### NOTES:

1. PACKAGE, LEADS, COVER MATERIAL: KOVAR™
2. BRACKET MATERIAL: ALUMINUM.
3. PLATING: ELECTROLYTIC GOLD 50 MICROINCHES MIN., OVER ELECTROLYTIC NICKEL 75 MICROINCHES MIN.
4. ALL DIMENSIONS ARE IN INCHES [MILLIMETERS].
5. TOLERANCES: ±.010 [0.25] UNLESS OTHERWISE SPECIFIED.
6. MARK LOT NUMBER ON LABEL WHERE SHOWN, WITH .030" MIN TEXT HEIGHT.

**Absolute Maximum Ratings**

Vdc	-0.3 Vdc to +25 Vdc
Vtune	0 to +15V
Storage Temperature	-65 to +150 °C
Operating Temperature	-40 to +85 °C

**Pin Descriptions**

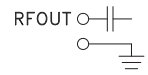
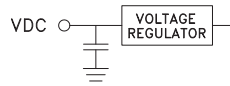
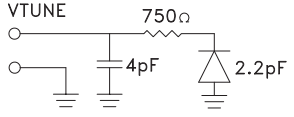
Pin Number	Function	Description	Interface Schematic
1	RFOUT	RF output (AC coupled) uses a female SMA connector.	
2	Vdc	Supply Voltage Vdc = +8V to +15V	
3	VTUNE	Control Voltage and Modulation Input uses a female SMA connector. Modulation bandwidth dependent on drive source impedance. See "Determining the FM Bandwidth of a Wideband Varactor Tuned VCO" application note.	
4	GND	Must be connected to power supply ground.	