



LOW NOISE AMPLIFIER MODULE, 5 - 9 GHz



Typical Applications

The HMC-C048 LNA is ideal for:

- Telecom Infrastructure
- Microwave Radio & VSAT
- Military & Space
- Test Instrumentation

Functional Diagram

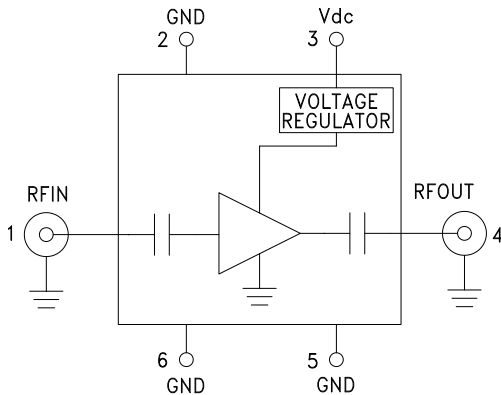

Features

- Low Noise Figure: 1.75 dB @ 6 GHz
- High Gain: 22 dB
- Output IP3: +25 dBm
- P1dB Output Power: +14.8 dBm
- 50 Ohm Matched & DC Blocked RF I/Os
- Hermetically Sealed Module
- Field Replaceable SMA Connectors
- 55 °C to +85 °C Operating Temperature

General Description

The HMC-C048 is a GaAs MMIC pHEMT Low Noise Amplifier in a miniature, hermetic module which operates between 5 and 9 GHz. This high dynamic range low noise amplifier module provides 22 dB of gain and up to +25 dBm of output IP3 while operating from a single positive supply between +8V and +16V. The amplifier I/Os are internally matched to 50 Ohms and DC blocked for robust performance. The module features removable coaxial connectors which can be detached to allow direct connection of the I/O pins to a microstrip or coplanar circuit.

Electrical Specifications, $T_A = +25^\circ \text{C}$, $V_{dc} = +12\text{V}$

Parameter	Min.	Typ.	Max.	Units
Frequency Range		5 - 9		GHz
Gain	18.5	22.5		dB
Gain Variation Over Temperature		0.015		dB/ °C
Noise Figure		1.75	2.3	dB
Input Return Loss		14		dB
Output Return Loss		15		dB
Output Power for 1 dB Compression (P1dB)	12	14.8		dBm
Saturated Output Power (Psat)		16.7		dBm
Output Third Order Intercept (IP3)		25		dBm
Supply Current		105	140	mA



**LOW NOISE AMPLIFIER
MODULE, 5 - 9 GHz**

Broadband Gain & Return Loss

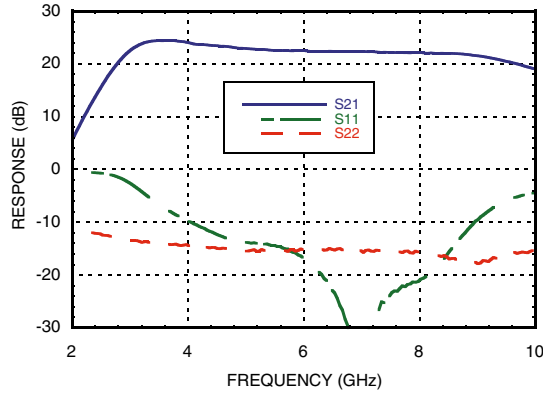

Gain vs. Temperature

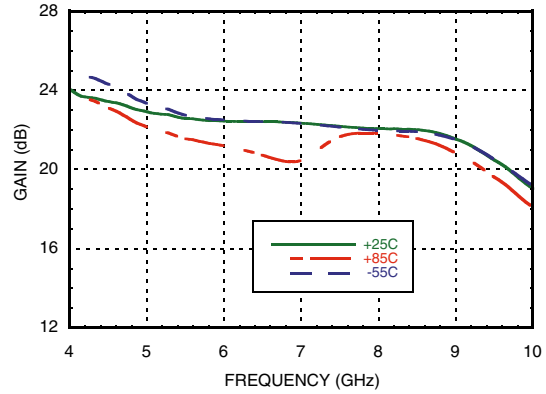

Input Return Loss vs. Temperature

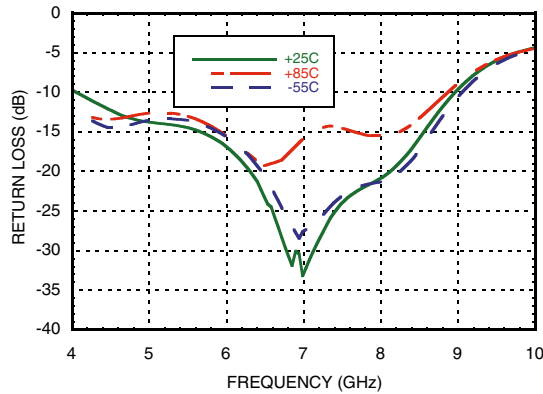

Output Return Loss vs. Temperature

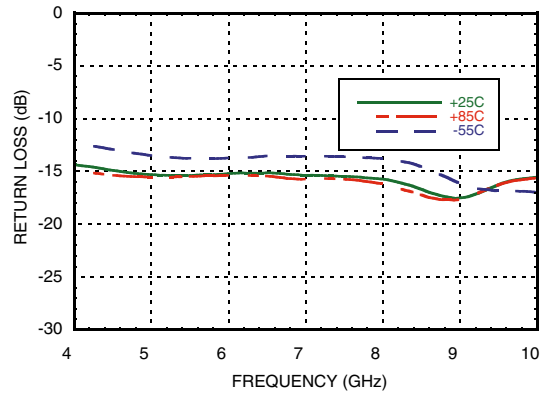

Reverse Isolation vs. Temperature

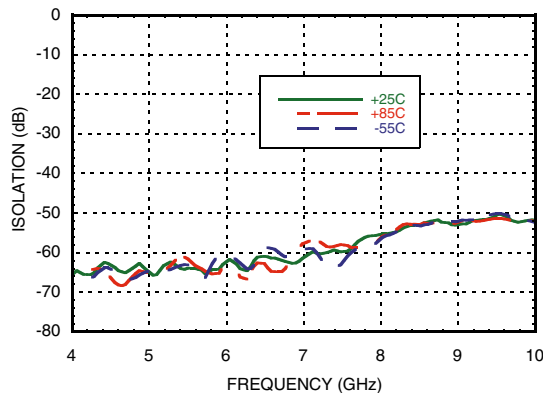

Noise Figure vs. Temperature

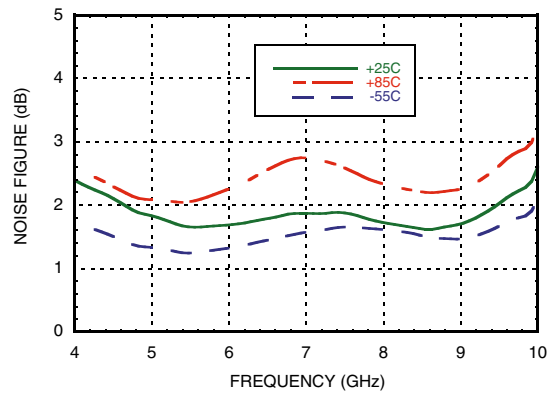



LOW NOISE AMPLIFIER MODULE, 5 - 9 GHz

Output P1dB vs. Temperature

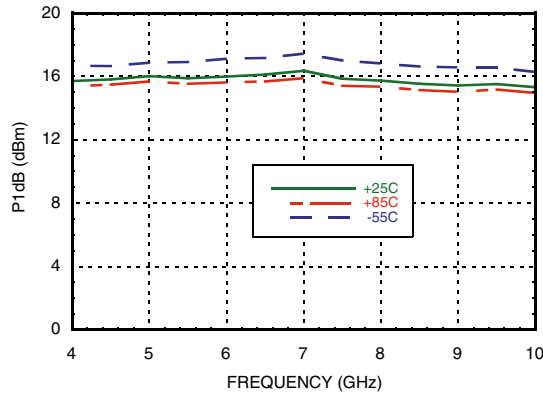

Psat vs. Temperature

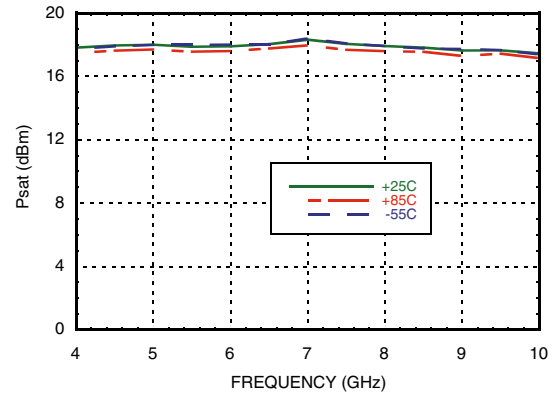

Output IP3 vs. Temperature

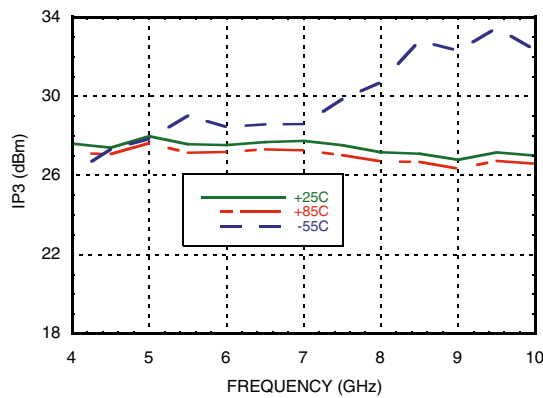



Absolute Maximum Ratings

Bias Supply Voltage (Vdc)	+16 Vdc
RF Input Power (RFIN)	+0 dBm
Storage Temperature	-65 to +150 °C
Operating Temperature	-55 to +85 °C

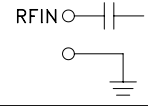

**ELECTROSTATIC SENSITIVE DEVICE
OBSERVE HANDLING PRECAUTIONS**

Pin Descriptions

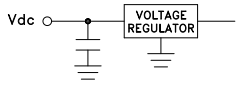
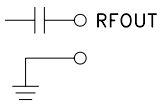
Pin Number	Function	Description	Interface Schematic
1	RFIN & RF Ground	RF input connector, coaxial female, field replaceable. This pin is AC coupled and matched to 50 Ohms.	
2, 5, 6	GND	One of these pins must be connected to power supply ground.	
3	Vdc	Power supply voltage for the amplifier.	
4	RFOUT & RF Ground	RF output connector, coaxial female, field replaceable. This pin is AC coupled and matched to 50 Ohms.	

Outline Drawing

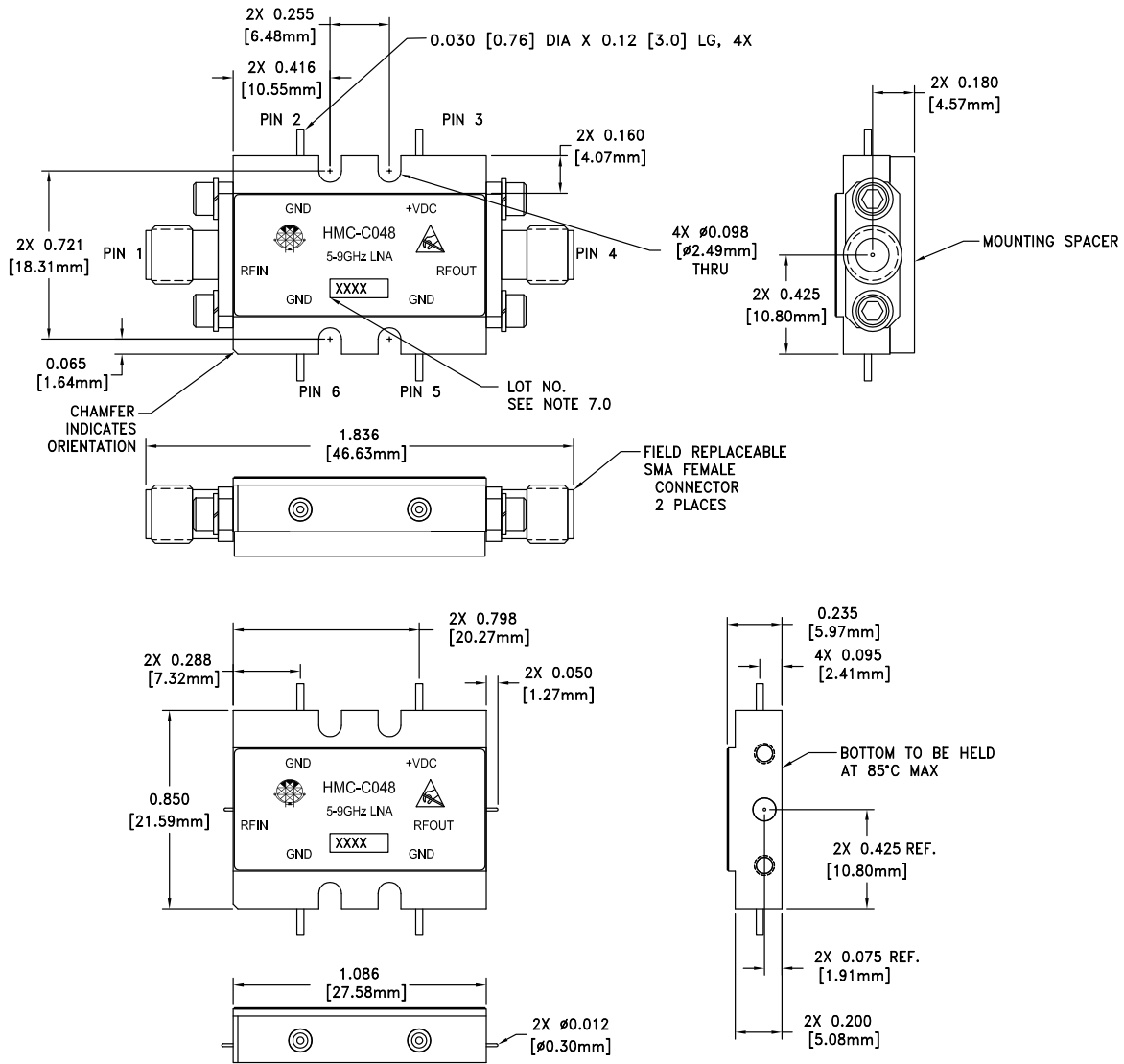

VIEW SHOWN WITH CONNECTORS AND MOUNTING SPACER REMOVED

Package Information

Package Type	C-10
Package Weight [1]	18.7 gms [2]
Spacer Weight	3.3 gms [2]

[1] Includes the connectors

[2] ±1 gms Tolerance

NOTES:

1. PACKAGE, LEADS, COVER MATERIAL: KOVAR™
2. FINISH: GOLD PLATE OVER NICKEL PLATE
3. ALL DIMENSIONS ARE IN INCHES [MILLIMETERS]
4. TOLERANCES:
 - 4.1 .XX = ±0.02
 - 4.2 .XXX = ±0.010
5. FIELD REPLACEABLE SMA CONNECTORS



**LOW NOISE AMPLIFIER
MODULE, 5 - 9 GHz**

Notes: