

Type 3AG / 3AP Fast Blow Fuse Series

6 x 32 mm Glass Tube
RoHS 6 Compliant

HF  3AG / 3AP Series, 6 x 32mm Fast Blow Fuse



Description

6x32mm Fast Blow, glass tube body cartridge fuse designed, approved and complied with UL and CSA standard 248-14.

Electrical Characteristics (UL / CSA STD.248-14)

Testing current	Blow Time	
	Minimum	Maximum
100%	4 Hrs.	N/A
135%	N/A	1 Hr
200%	N/A	5 sec

Features

- Meet UL and CSA standard 248-14
- Wide operating temperature range
- Bulk and Tape & Reel packing available
- RoHS6 compliant
- Halogen Free
- Leadfree

Applications





Provide individual protection for components or internal circuits.

- Power Supplies
- Battery charger
- Monitor
- Adapter

LEAD FREE = 

HALOGEN FREE = 

Safety Agency Approvals

SAFETY AGENCY	SAFETY AGENCY CERTIFICATE NUMBER	AMPERE RANGE / VOLT @ I.R.ABILITY
	E20624	100mA -10A / 250V AC @200A 100mA - 15A / 125V AC @10,000A
	LR39772	
	JET 1037-31003-1010 JET 1037-31003-1011	1A - 5A / 125V AC @500A
	JET 1037-31003-1007	>5A - 15A / 125V AC @300A
		100mA -10A / 250V AC @200A 100mA - 15A / 125V AC @10,000A

Specifications subject to change without notice

Type 3AG / 3AP Fast Blow Fuse Series

6 X 32 mm GlassTube
RoHS 6 Compliant



3AG May 2012D

Electrical Specifications

Catalog Number	Ampere Rating	Typical Cold Resistance (ohm)	Volt-drop @100% In (Volt) Max.	Voltage Rating (V)	Interrupting Rating	Melting I ² T <10 m Sec (A ² Sec)	Melting I ² T @ 10 In (A ² Sec)	Maximum Power Dissipation (W)	Agency Approvals			
3AG(3AP) 100-R	100mA	11.3	4.62	250	100mA - 10A / 250V AC @200A 100mA - 15A / 125V AC @10,000A	0.002	0.002	0.59	Y	Y		Y
3AG(3AP) 125-R	125mA	10.5	5.18	250		0.004	0.003	0.80	Y	Y		Y
3AG(3AP) 160-R	160mA	7.3	4.85	250		0.008	0.006	0.94	Y	Y		Y
3AG(3AP) 200-R	200mA	5.0	4.38	250		0.014	0.010	1.10	Y	Y		Y
3AG(3AP) 250-R	250mA	3.4	4.05	250		0.025	0.019	1.29	Y	Y		Y
3AG(3AP) 300-R	300mA	2.5	3.54	250		0.044	0.034	1.51	Y	Y		Y
3AG(3AP) 375-R	375mA	1.86	3.35	250		0.071	0.055	1.64	Y	Y		Y
3AG(3AP) 400-R	400mA	1.32	3.22	250		0.08	0.08	1.71	Y	Y		Y
3AG(3AP) 500-R	500mA	1.19	3.17	250		0.14	0.11	1.88	Y	Y		Y
3AG(3AP) 750-R	750mA	0.66	2.54	250		0.19	0.17	2.15	Y	Y		Y
3AG(3AP) 1-R	1A	0.155	0.28	250		1.4	1.4	0.37	Y	Y	Y	Y
3AG(3AP) 1.25-R	1.25A	0.114	0.27	250		2.4	2.5	0.44	Y	Y	Y	Y
3AG(3AP) 1.6-R	1.6A	0.085	0.27	250		4.2	4.4	0.51	Y	Y	Y	Y
3AG(3AP) 2-R	2A	0.057	0.22	250		7.2	7.6	0.59	Y	Y	Y	Y
3AG(3AP) 2.5-R	2.5A	0.043	0.21	250		12	13	0.70	Y	Y	Y	Y
3AG(3AP) 3-R	3A	0.033	0.17	250		21	23	0.83	Y	Y	Y	Y
3AG(3AP) 3.5-R	3.5A	0.027	0.18	250		28	31	0.91	Y	Y	Y	Y
3AG(3AP) 4-R	4A	0.024	0.17	250		36	40	1.00	Y	Y	Y	Y
3AG(3AP) 5-R	5A	0.018	0.16	250		63	70	1.20	Y	Y	Y	Y
3AG(3AP) 6-R	6A	0.014	0.15	250		107	123	1.40	Y	Y	Y	Y
3AG(3AP) 7-R	7A	0.012	0.16	250		141	162	1.60	Y	Y	Y	Y
3AG(3AP) 8-R	8A	0.010	0.15	250		184	214	1.70	Y	Y	Y	Y
3AG(3AP) 10-R	10A	0.008	0.13	250		316	372	2.00	Y	Y	Y	Y
3AG(3AP) 12-R	12A	0.006	0.13	250		501	597	2.40		Y	Y	Y
3AG(3AP) 15-R	15A	0.006	0.15	250		845	1023	2.80		Y	Y	Y

Consult manufacturer for other ratings

CORPORATE OFFICE

Bel Fuse Inc.

206 Van Vorst Street
Jersey City, NJ 07302
Tel 201-432-0463
Fax 201-432-9542
E-Mail: belfuse@belf.com
Website: www.belfuse.com

FAR EAST OFFICE

Bel Fuse Ltd.

8/F Luk Hop Industrial Building
8 Luk Hop Street
San Po Kong
Kowloon, Hong Kong
Tel 852-2328-5515
Fax 852-2352-3706

EUROPE OFFICE

Bel Fuse Europe Ltd.

Preston Technology Management Centre
Marsh Lane, Suite F15
Preston, Lancashire, PR1 8UQ
United Kingdom
Tel 44-1772-556601
Fax 44-1772-561008

EUROPE

Bel Stewart GmbH

Industriestrasse 20
61381 Friedrichsdorf
Germany
Tel 49-6172-9552-0
Fax 49-6172-9552-40

Type 3AG / 3AP Fast Blow Fuse Series

6 x 32 mm Glass Tube

RoHS 6 Compliant



3AG May2012C

Temperature Derating Curve

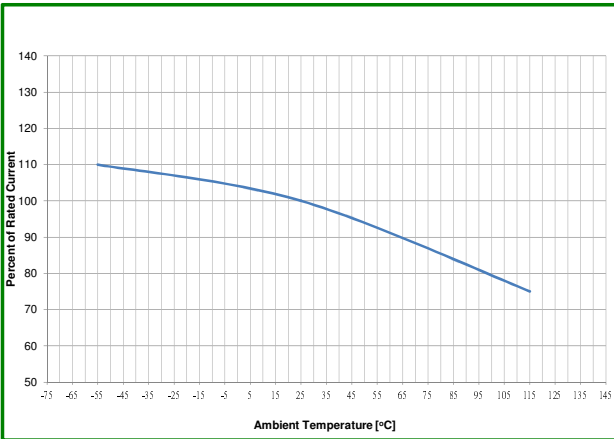

Average Time Current Curve

3AG / 3AP - TIME CURRENT CHARACTERISTIC CURVE

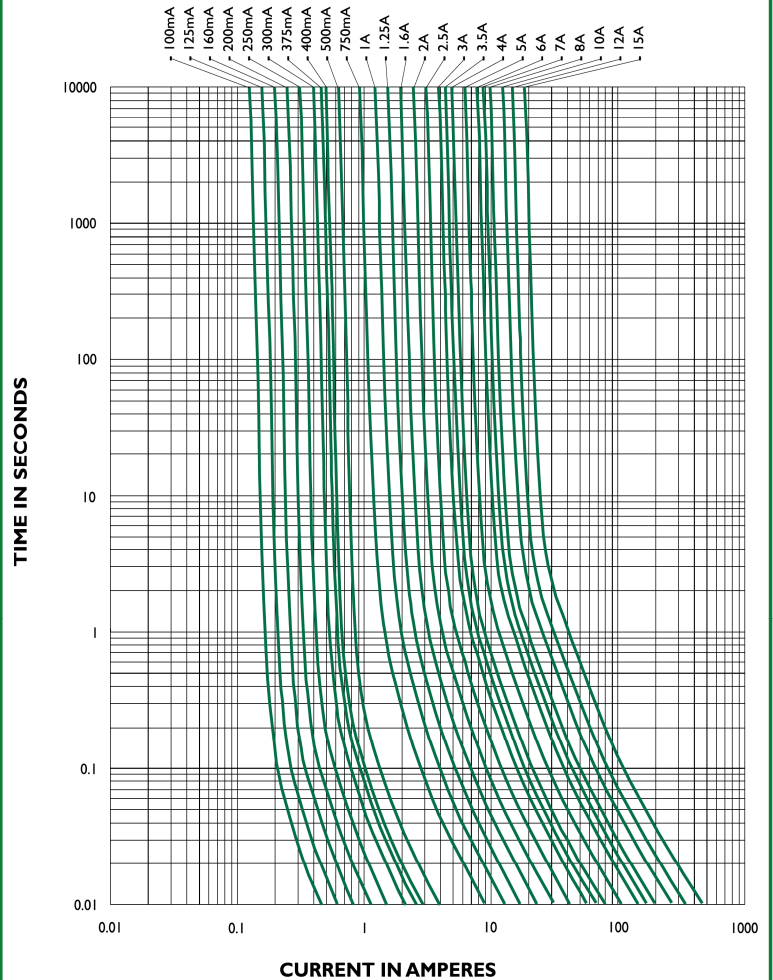

Soldering Parameters

Lead-free Wave Soldering Profile	
Wave Soldering Parameter	
Average ramp-up rate	200°C / second
Heating rate during preheat	typical 1 - 2°C / second Max. 4°C / second
Final preheat temperature	within 125°C of soldering temperature
Peak temperature T _p	260°C
Time within +0 °C / -5°C of actual peak temperature	10 seconds
Ramp-down rate	5 °C / second max.

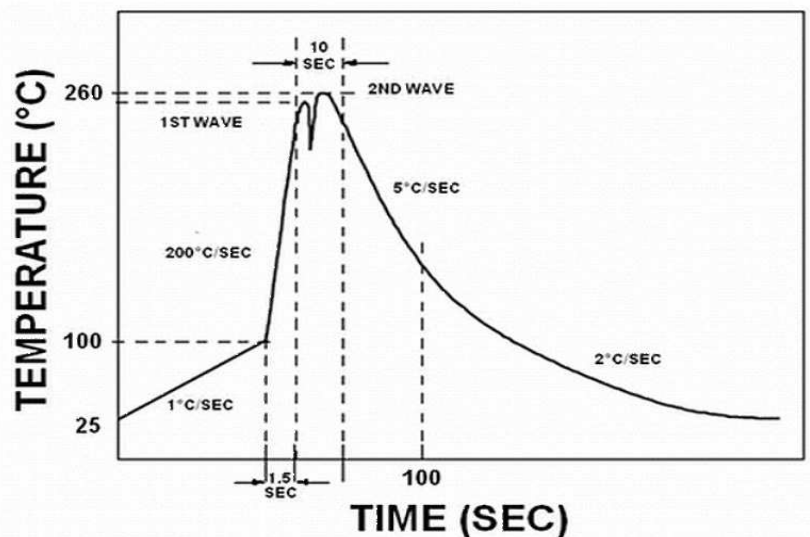

Type 3AG / 3AP Fast Blow Fuse Series

6 X32mm Glass Tube
RoHS 6 Compliant



3AG May2012D

Physical Specifications

Materials	Body : Glass
	Cap : Nickel Plated Brass Caps
	Leads: Matte Tin Plated Copper
Marking	On Fuse:
	"bel" , "3AG" , " Current Rating" ,"Voltage Rating" ,
	"Appropriate Safety Logos" , " "(RoHS 6 compliant)
	On label:
	"bel" , "3AG" , or "3AP" ,"Current Rating" ,"Voltage Rating" ,"Interrupting Rating" , "Appropriate Safety Logos" and " " (China RoHS compliant).

Environmental Specifications

Shock Resistance	MIL-STD-202G, Method 213B, Test Condition I (100 G's peak for 6 milliseconds; Sawtooth Waveform)
Vibration Resistance	MIL-STD-202G, Method 201A (10-55 Hz, 0.06 inch, total excursion).
Salt Spray Resistance	MIL-STD-202G, Method 101E, Test condition B (48 hrs).
Insulation Resistance	MIL-STD-202G, Method 302, Test Condition A (After Opening) 10,000 ohms minimum.
Solderability	MIL-STD-202G, Method 208H
Resistance to solder Heat	MIL-STD-202G Method 210F, Test Condition B. (260+/-5 °C, 10+/-1 sec)
Thermal Shock	MIL-STD-202G, Method 107G, Test Condition B (-65 °C to +125 °C).
Operating Temperature	-55 °C to +125 °C
Terminal Strength	IEC-68-2-21

Mechanical Dimensions

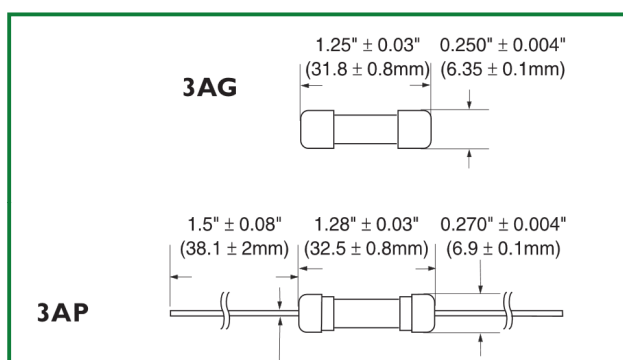

Ordering Information

06XX R XXXX - X X

FUSE TYPE
0601 = 3AG
0611 = 3AP
R = RoHS Compliant

AMPERE RATING
Refer to fuse FGNO explanation table

QUANTITY & PACKAGING CODE
3 = 100 pcs / Bulk bag, 1K / Box ,Cartridge Type Fuse for 0601
= 500 pcs/ Bulk bag / box, Pigtail Type Fuse for 0611
7 = 1000 pcs / Reel, Tape and Reel

VOLTAGE CODE
3 = 250V
2 = 125V

* Ratings 7A and less have 0.032" diameter lead;
Ratings 8A and above have 0.040" diameter lead.

Specifications subject to change without notice

Packaging

Packaging Option	Packaging Specification	Quantity	Packaging Code	Inside Tape Spacing
Bulk	N/A	100	33 / 32	N/A
Bulk (Pigtail Type)	N/A	500	33 / 32	N/A
Tape & Reel, 10 mm Pitch	EIA-296-F	1000	73 / 72	73

CORPORATE OFFICE

Bel Fuse Inc.
206 Van Vorst Street
Jersey City, NJ 07302
Tel 201-432-0463
Tel 201-432-9542
Fax 201-432-9542
E-Mail: belfuse@belf.com
Website: www. belfuse.com

FAR EAST OFFICE

Bel Fuse Ltd.
8/F Luk Hop Industrial Building
8 Luk Hop Street
San Po Kong
Kowloon, Hong Kong
Tel 852-2328-5515
Tel 852-2352-3706

EUROPE OFFICE

Bel Fuse Europe Ltd.
Preston Technology Management Centre
Marsh Lane, Suite F15
Preston, Lancashire, PR1 8UQ
United Kingdom
Tel 44-1772-556601
Fax 44-1772-561008

EUROPE

Bel Stewart GmbH
Industriestrasse 20
61381 Friedrichsdorf
Germany
Tel 49-6172-9552-0
Fax 49-6172-9552-40