

Wide Input Voltage 4.0 A Step Down Regulator

Features and Benefits

- 8 to 25 V input range
- Integrated DMOS switch
- Adjustable fixed off-time
- Adjustable output

Package: 8-Lead SOIC with exposed thermal pad (suffix LJ)

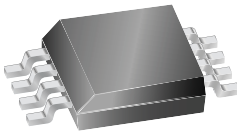

Approximate Scale 1:1



Description

The A8697 is a constant off-time current mode step-down regulator with a wide input voltage range. Regulation voltage is set by external resistors, to output voltages as low as 0.8 V.

The A8697 includes an integrated power DMOS switch to reduce the total solution footprint. It also features internal compensation, allowing users to design stable regulators with minimal design efforts.

The off-time can be set with an external resistor, allowing flexibility in inductor selection. Additionally, the A8697 has a logic level enable pin which can shut the device down and put it into a low quiescent current mode for power sensitive applications.

The A8697 is supplied in a low-profile 8-lead SOIC with exposed pad (package LJ). Applications include:

- Applications with 8 to 25 V input
- Consumer electronics, networking equipment
- 12 V lighter-powered applications (portable DVD, etc.)
- Point of Sale (POS) applications

Typical Application

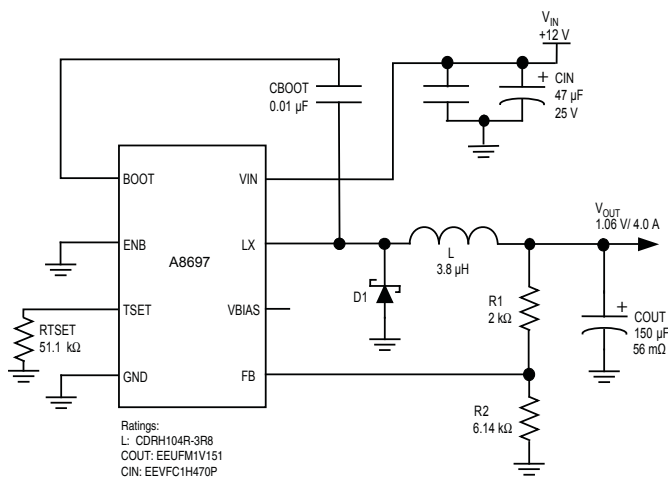

Circuit for 12 V step down to 1.06 V at 4 A

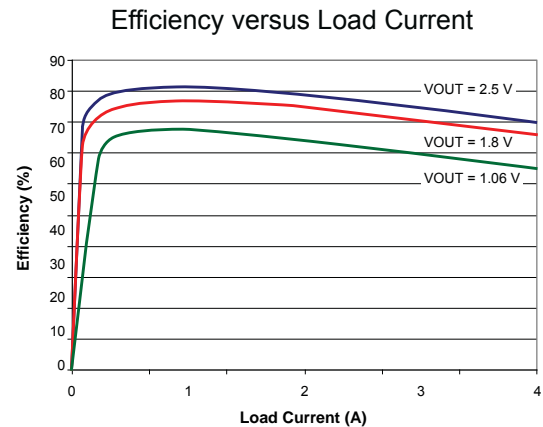

Efficiency curve for circuit at left

Absolute Maximum Ratings

| Characteristic | Symbol | Conditions | Min. | Typ. | Max. | Units |
|-------------------------------------|-------------------|------------|------|------|------|-------|
| VIN Supply Voltage | V_{IN} | | – | – | 25 | V |
| VBIAS Input Voltage | V_{BIAS} | | –0.3 | – | 7 | V |
| Switching Voltage | V_S | | –1 | – | – | V |
| ENB Input Voltage | V_{ENB} | | –0.3 | – | 7 | V |
| Operating Ambient Temperature Range | T_A | Range E | –40 | – | 85 | °C |
| Junction Temperature | $T_J(\text{max})$ | | – | – | 150 | °C |
| Storage Temperature | T_S | | –55 | – | 150 | °C |

*Output current rating may be limited by duty cycle, ambient temperature, and heat sinking. Under any set of conditions, do not exceed the specified current ratings, or a junction temperature, T_J , of 150°C.

Package Thermal Characteristics*

| Package | $R_{\theta JA}$ (°C/W) | PCB |
|---------|---------------------------|---------|
| LJ | 35 | 4-layer |



* Additional information is available on the Allegro website.

Ordering Information

Use the following complete part numbers when ordering:

| Part Number ^a | Packing ^b | Description |
|--------------------------|-------------------------------|---|
| A8697ELJTR-T | 13 in. reel, 3000 pieces/reel | LJ package, SOIC surface mount with exposed thermal pad |

^aLeadframe plating 100% matte tin.

^bContact Allegro for additional packing options.

Functional Block Diagram

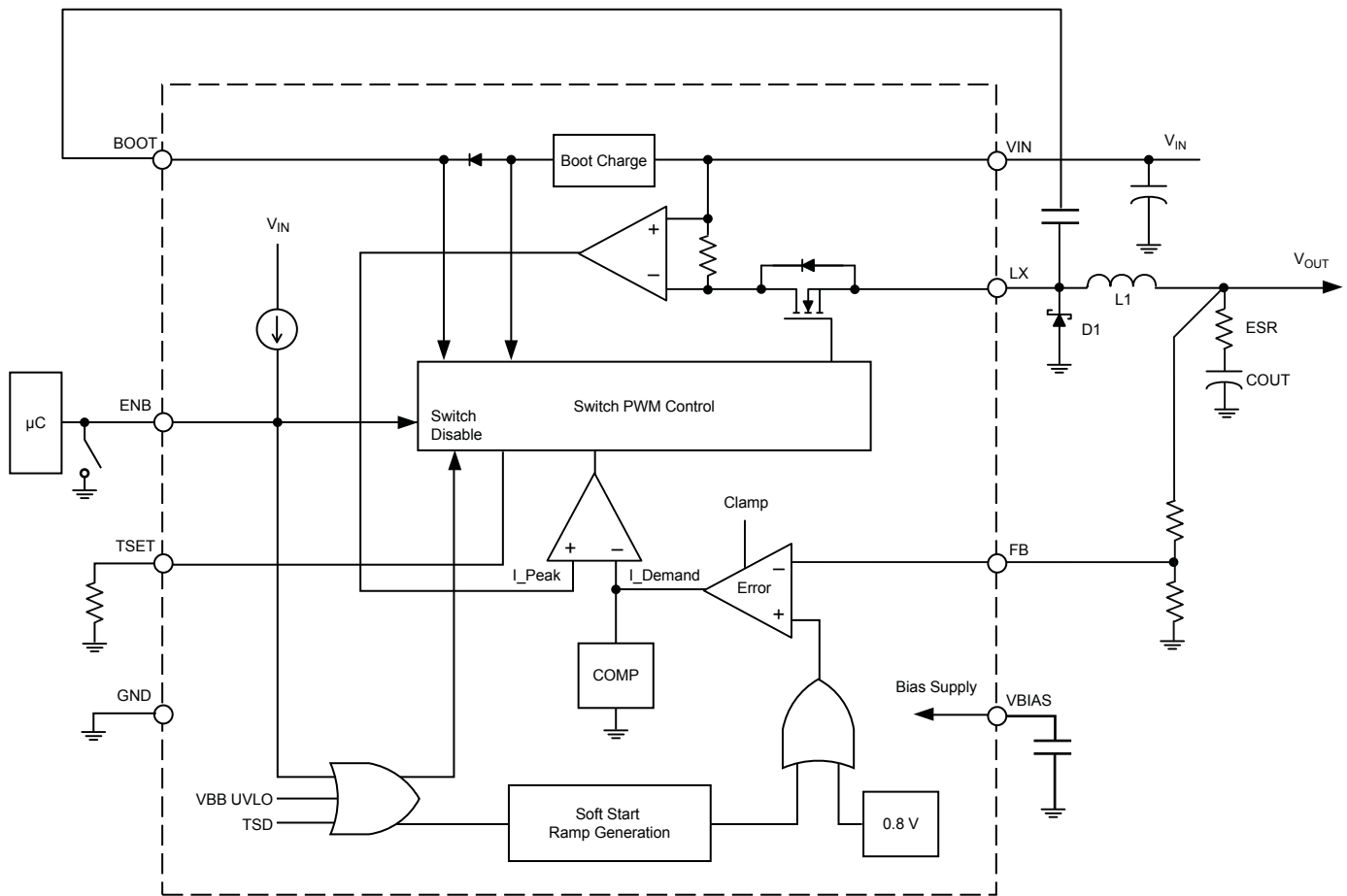

ELECTRICAL CHARACTERISTICS^{1,2} at $T_A = 25^\circ\text{C}$, $V_{IN} = 8$ to 25 V (unless noted otherwise)

| Characteristics | Symbol | Test Conditions | Min. | Typ. | Max. | Units |
|------------------------------|-----------------|--|-------|------|-------|------------------|
| VIN Quiescent Current | $I_{VIN(Q)}$ | $V_{ENB} = \text{LOW}$, $V_{IN} = 12$ V, $V_{BIAS} = 3.2$ V, $V_{FB} = 1.5$ V (not switching) | – | 1.0 | – | mA |
| | | $V_{ENB} = \text{LOW}$, $V_{IN} = 12$ V, $V_{BIAS} < 3$ V, $V_{FB} = 1.5$ V | – | 4.1 | – | mA |
| | | $V_{ENB} = \text{HIGH}$ | – | – | 100 | μA |
| VBIAS Input Current | I_{BIAS} | $V_{BIAS} = V_{OUT}$ | – | 3.8 | 5 | mA |
| Buck Switch On Resistance | $R_{DS(on)}$ | $T_A = 25^\circ\text{C}$, $I_{OUT} = 3$ A | – | 180 | – | m Ω |
| Fixed Off-Time Proportion | | Based on calculated value | –15 | – | 15 | % |
| Feedback Voltage | V_{FB} | | 0.784 | 0.8 | 0.816 | V |
| Output Voltage Regulation | V_{OUT} | $I_{OUT} = 0$ mA to 3 A | –3 | – | 3 | % |
| Feedback Input Bias Current | I_{FB} | | –400 | –100 | 100 | nA |
| Soft Start Time | t_{ss} | | 5 | 10 | 15 | ms |
| Buck Switch Current Limit | I_{CL} | $V_{FB} > 0.4$ V | 4.8 | 6.2 | 7.2 | A |
| | | $V_{FB} < 0.4$ V | – | 2.7 | – | A |
| ENB Open Circuit Voltage | V_{OC} | Output disabled | 2.0 | – | 7 | V |
| ENB Input Voltage Threshold | $V_{ENB(0)}$ | LOW level input (Logic 0), output enabled | – | – | 1.0 | V |
| ENB Input Current | $I_{ENB(0)}$ | $V_{ENB} = 0$ V | –10 | – | –1 | μA |
| VIN Undervoltage Threshold | V_{UVLO} | V_{IN} rising | 6.6 | 6.9 | 7.2 | V |
| VIN Undervoltage Hysteresis | $V_{UVLO(hys)}$ | V_{IN} falling | 0.7 | – | 1.1 | V |
| Thermal Shutdown Temperature | T_{JTSD} | Temperature increasing | – | 165 | – | $^\circ\text{C}$ |
| Thermal Shutdown Hysteresis | $T_{JTSD(hys)}$ | Recovery = $T_{JTSD} - T_{JTSD(hys)}$ | – | 15 | – | $^\circ\text{C}$ |

¹Negative current is defined as coming out of (sourcing) the specified device pin.

²Specifications over the junction temperature range of 0°C to 125°C are assured by design and characterization.

Performance Characteristics

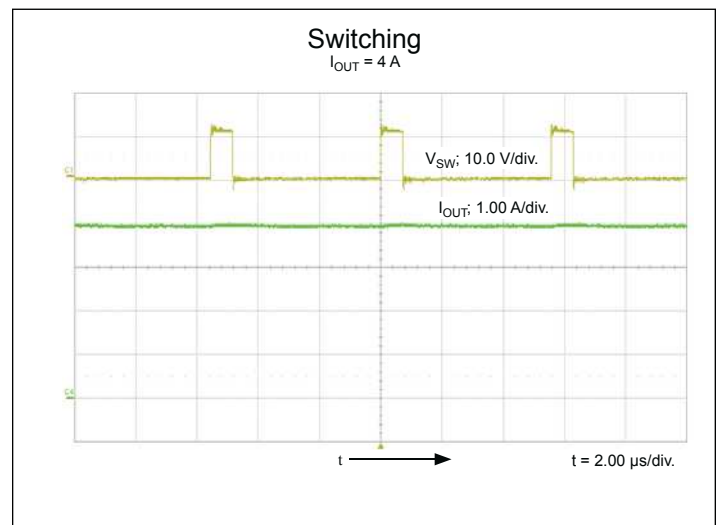
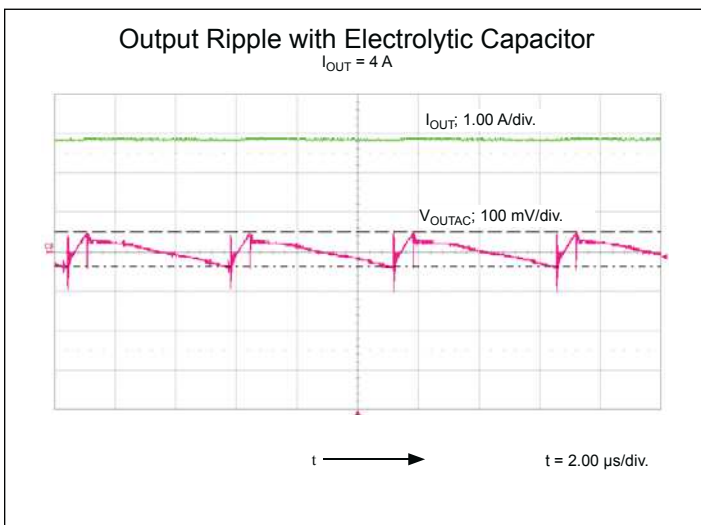
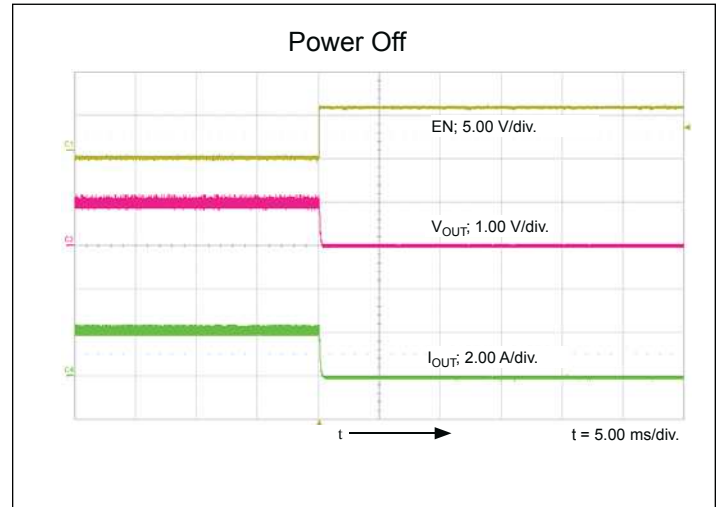
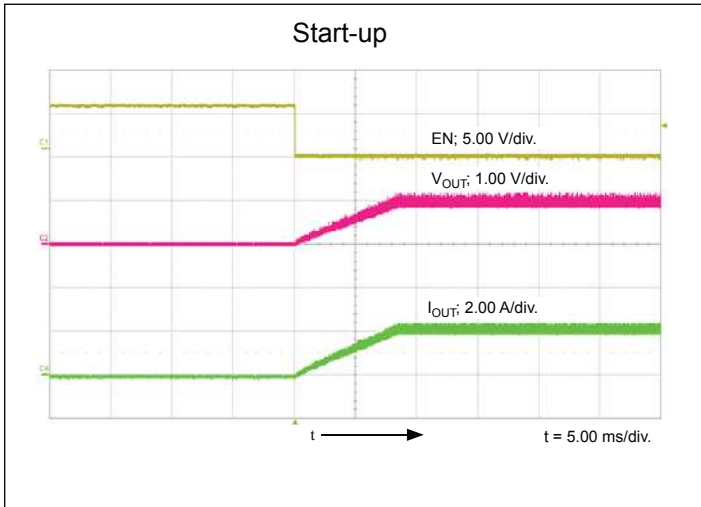

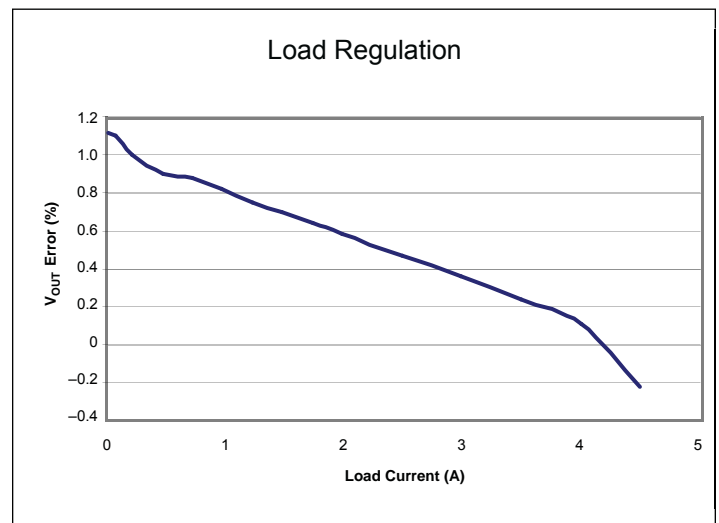
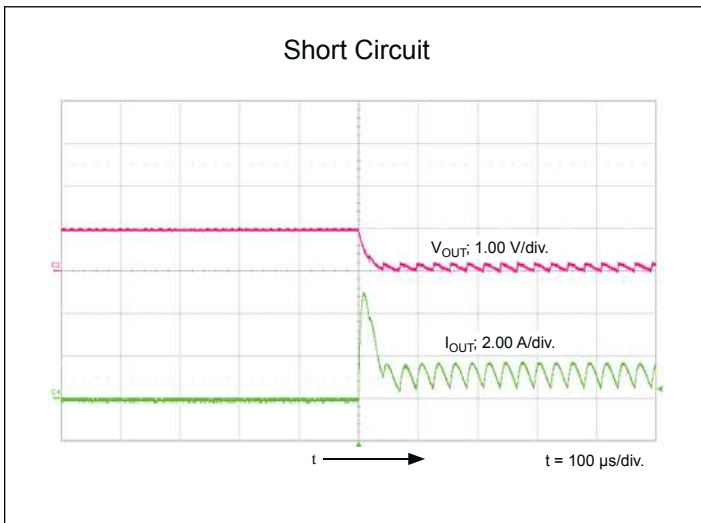
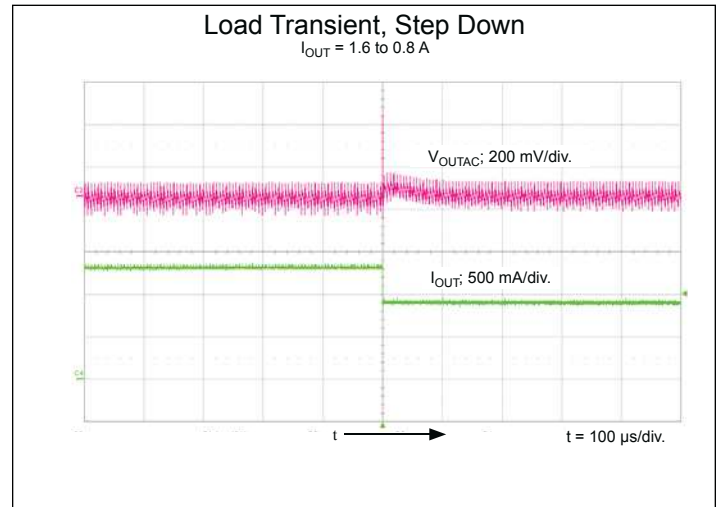
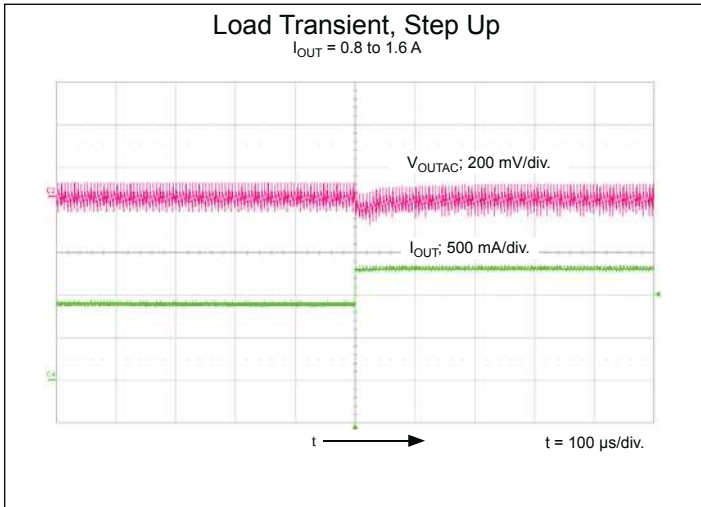

Functional Description

The A8697 is a fixed off-time, current-mode-controlled buck switching regulator. The regulator requires an external clamping diode, inductor, and filter capacitor, and operates in both continuous and discontinuous modes. An internal blanking circuit is used to filter out transients resulting from the reverse recovery of the external clamp diode. Typical blanking time is 200 ns.

The value of a resistor between the TSET pin and ground determines the fixed off-time (see graph in the t_{OFF} section).

V_{OUT} The output voltage is adjustable from 0.8 to 20 V, based on the combination of the value of the external resistor divider and the internal 0.8 V $\pm 2\%$ reference. The voltage can be calculated with the following formula:

$$V_{OUT} = V_{FB} \times (1 + R1/R2) \quad (1)$$

Light Load Regulation. To maintain voltage regulation during light load conditions, the switching regulator enters a cycle-skipping mode. As the output current decreases, there remains some energy that is stored during the power switch minimum on-time. In order to prevent the output voltage from rising, the regulator skips cycles once it reaches the minimum on-time, effectively making the off-time larger.

Soft Start. An internal ramp generator and counter allow the output to slowly ramp up. This limits the maximum demand on the external power supply by controlling the inrush current required to charge the external capacitor and any dc load at startup. Internally, the ramp is set to 10 ms nominal rise time. During soft start, current limit is 3.5 A minimum.

The following conditions are required to trigger a soft start:

- $V_{IN} > 6$ V
- ENB pin input falling edge
- Reset of a TSD (thermal shut down) event

V_{BIAS} To improve overall system efficiency, the regulator output, V_{OUT}, is connected to the VBIAS input to supply the operating bias current during normal operating conditions. During startup the circuitry is run off of the VIN supply. VBIAS should be connected to VOUT when the V_{OUT} target level is between 3.3 and 5 V. If the output voltage is less than 3.3 V, then the A8697 can operate with an internal supply and pay a penalty in efficiency, as the bias current will come from the high voltage supply, VIN. VBIAS can also be supplied with an external voltage source. No power-up sequencing is required for normal operation.

ON/OFF Control. The ENB pin is externally pulled to ground to enable the device and begin the soft start sequence. When the ENB is open circuited, the switcher is disabled and the output decays to 0 V.

Protection. The buck switch will be disabled under one or more of the following fault conditions:

- $V_{IN} < 6$ V
- ENB pin = open circuit
- TSD fault

When the device comes out of a TSD fault, it will go into a soft start to limit inrush current.

t_{OFF} The value of a resistor between the TSET pin and ground determines the fixed off-time. The formula to calculate t_{OFF} (μ s) is:

$$t_{OFF} = R_{SET} \left(\frac{1 - 0.03 V_{BIAS}}{10.2 \times 10^9} \right), \quad (2)$$

where R_{TSET} (k Ω) is the value of the resistor. Results are shown in the following graph:

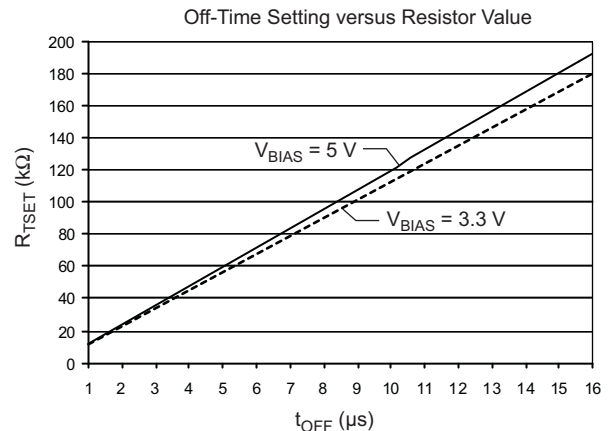

t_{ON} From the volt-second balance of the inductor, the turn-on time, t_{on}, can be calculated approximately by the equation:

$$t_{ON} = \frac{(V_{OUT} + V_f + I_{OUT} \times R_L) \times t_{OFF}}{V_{IN} - I_{OUT} \times R_{DS(on)} - I_{OUT} \times R_L - V_{OUT}} \quad (3)$$

where

V_f is the voltage drop across the external Schottky diode, R_L is the winding resistance of the inductor, and R_{DS(on)} is the on-resistance of the switching MOSFET.

The switching frequency is calculated as follows:

$$f_{SW} = \frac{1}{t_{ON} + t_{OFF}} \quad (4)$$

Shorted Load. If the voltage on the FB pin falls below 0.4 V, the regulator will invoke a 1.5 A typical overcurrent limit to handle the shorted load condition at the regulator output. For low output voltages at power up and in the case of a shorted output, the off-time is extended to prevent loss of control of the current limit due

to the minimum on-time of the switcher.

The extension of the off-time is based on the value of the TSET multiplier and the FB voltage, as shown in the following table:

| V_{FB} (V) | TSET Multiplier |
|--------------|--------------------|
| < 0.16 | $8 \times t_{OFF}$ |
| < 0.32 | $4 \times t_{OFF}$ |
| < 0.5 | $2 \times t_{OFF}$ |
| > 0.5 | t_{OFF} |

Component Selection

L1. The inductor must be rated to handle the total load current. The value should be chosen to keep the ripple current to a reasonable value. The ripple current, I_{RIPPLE} , can be calculated by:

$$I_{RIPPLE} = V_{L(OFF)} \times t_{OFF} / L \quad (5)$$

$$V_{L(OFF)} = V_{OUT} + V_f + I_{L(AV)} \times R_L \quad (6)$$

Example:

Given $V_{OUT} = 1.06$ V, $V_f = 0.3$ V, $V_{IN} = 12$ V, $I_{LOAD} = 4.0$ A, power inductor with $L = 3.8$ μ H and $R_L = 0.05$ Ω Rdc at 55°C, $t_{OFF} = 5.0$ μ s, and $R_{DS(on)} = 0.2$ Ω .

Substituting into equation 6:

$$V_{L(OFF)} = 1.06 \text{ V} + 0.3 \text{ V} + 4 \text{ A} \times 0.05 \text{ } \Omega = 1.56 \text{ V}$$

Substituting into equation 5:

$$I_{RIPPLE} = 1.56 \text{ V} \times 5 \text{ } \mu\text{s} / 3.8 \text{ } \mu\text{H} = 2.05 \text{ A}$$

The switching frequency, f_{SW} , can then be estimated by:

$$f_{SW} = 1 / (t_{ON} + t_{OFF}) \quad (7)$$

$$t_{ON} = I_{RIPPLE} \times L / V_{L(ON)} \quad (8)$$

$$V_{L(ON)} = V_{IN} - I_{L(AV)} \times R_{DS(on)} - I_{L(AV)} \times R_L - V_{OUT} \quad (9)$$

Substituting into equation 9:

$$V_{L(ON)} = 12 \text{ V} - 4 \text{ A} \times 0.2 \text{ } \Omega - 4 \text{ A} \times 0.05 \text{ } \Omega - 1.06 \text{ V} = 9.94 \text{ V}$$

Substituting into equation 8:

$$t_{ON} = 2.05 \text{ A} \times 3.8 \text{ } \mu\text{H} / 9.94 \text{ V} = 0.785 \text{ } \mu\text{s}$$

Substituting into equation 7:

$$f_{SW} = 1 / (5 \text{ } \mu\text{s} + 0.785 \text{ } \mu\text{s}) = 173 \text{ kHz}$$

Higher inductor values can be chosen to lower the ripple current. This may be an option if it is required to increase the total maximum current available above that drawn from the switching regulator. Please refer to the Maximum Load Current graph for the maximum load recommended.

D1. The Schottky catch diode should be rated to handle 1.2 times the maximum load current. The voltage rating should be higher than the maximum input voltage expected during all operating conditions. The duty cycle for high input voltages can be very close to 100%.

COUT. The main consideration in selecting an output capacitor is voltage ripple on the output. For electrolytic output capacitors, a low-ESR type is recommended.

The peak-to-peak output voltage ripple is simply $I_{RIPPLE} \times \text{ESR}$. Note that increasing the inductor value can decrease the ripple current. The ESR should be in the range from 50 to 500 m Ω .

RTSET Selection. Correct selection of RTSET values will ensure that minimum on-time of the switcher is not violated and prevent the switcher from cycle skipping. For a given V_{IN} to V_{OUT} ratio, the RTSET value must be greater than or equal to the value defined by the curve in the plot below.

Note. The curve represents the minimum RTSET value. When calculating R_{TSET} , be sure to use $V_{IN(max)} / V_{OUT(min)}$. Resistor

tolerance should also be considered, so that under no operating conditions the resistance on the TSET pin is allowed to go below the minimum value.

FB Resistor Selection. The impedance of the FB network should be kept low to improve noise immunity. Large value resistors can pick up noise generated by the inductor, which can affect voltage regulation of the switcher.

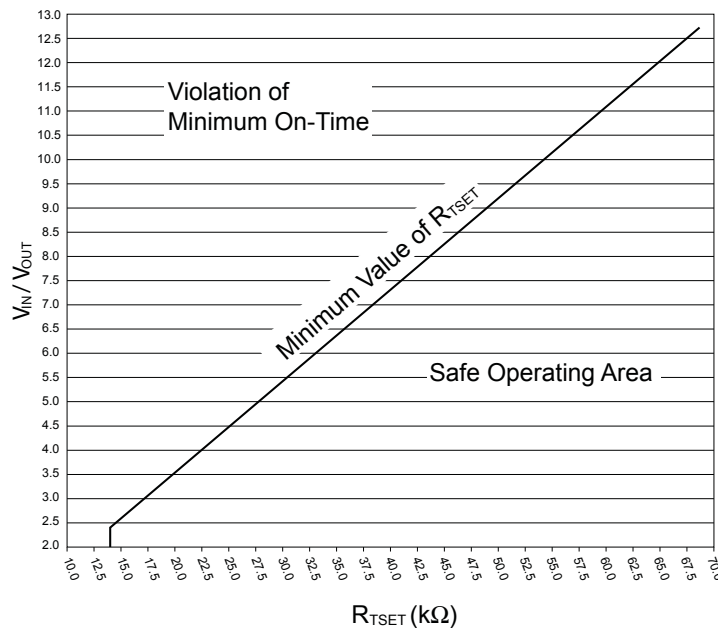

Maximum Load Current
Using Allegro A8698 Evaluation Board*

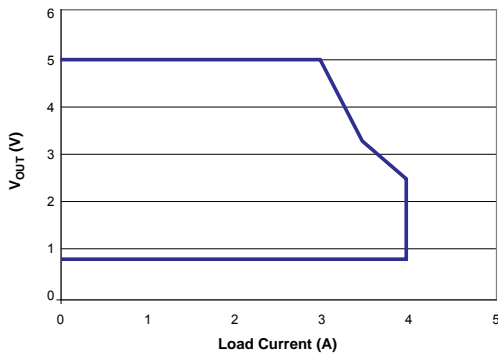

*To test maximum load current, the A8697 IC was mounted on an A8698 Evaluation Board (see next page), and a thermocouple attached to the IC case to measure T_C . The assembly was placed in an environmental chamber in still air. The initial air temperature in the chamber temperature was $60^\circ C$ (T_A), and during the test, I_{OUT} was adjusted until $T_C = 115^\circ C$.

Application Circuit Evaluation Board for the A8697

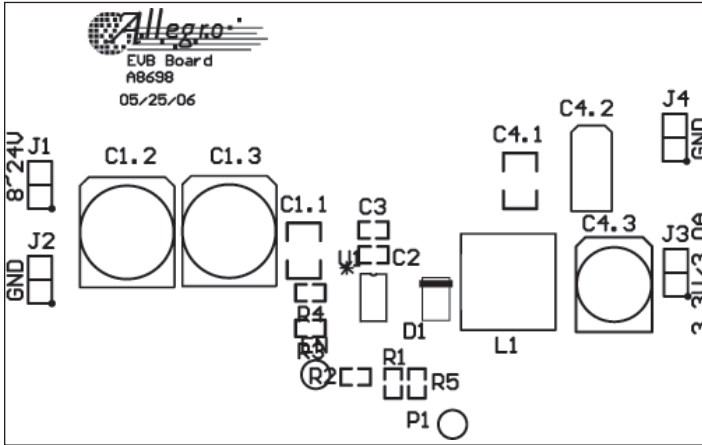

Silkscreen Layer

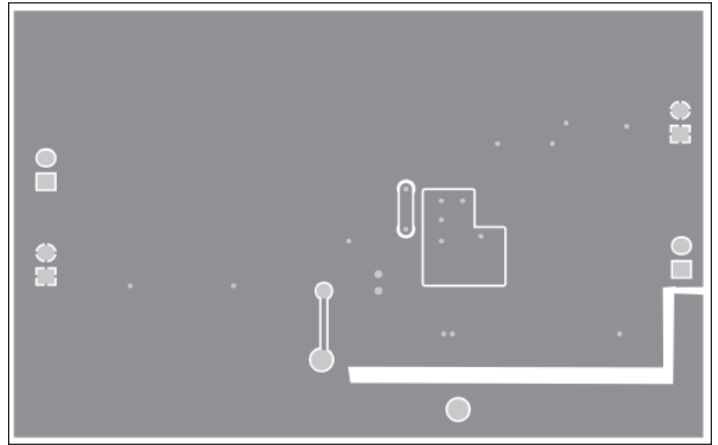

Bottom Layer

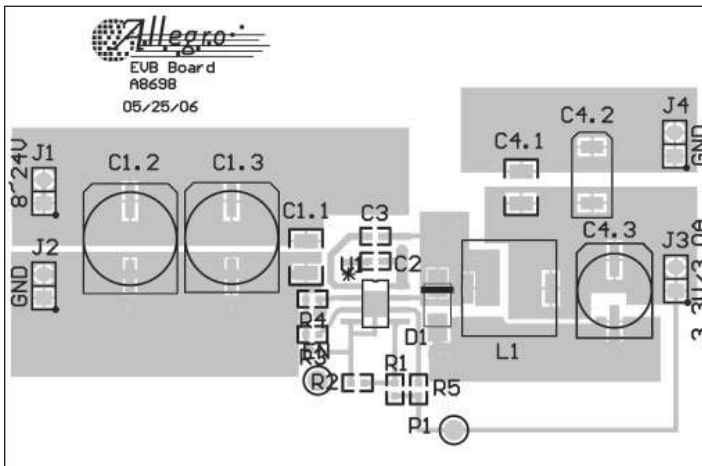

Top and Silkscreen Layers

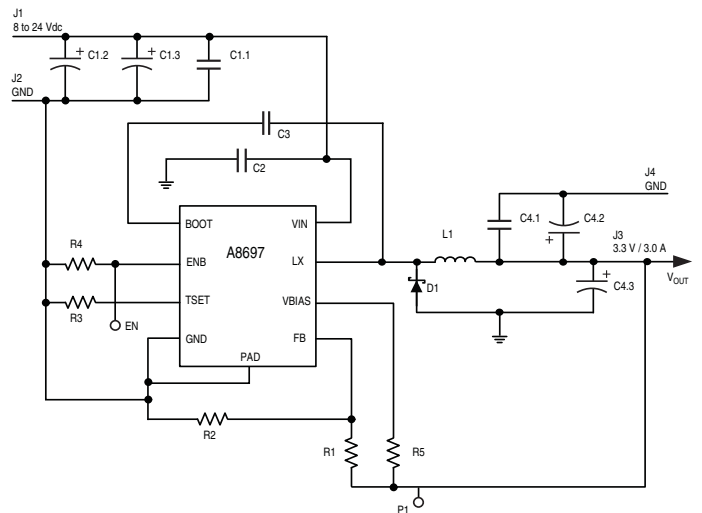

Evaluation Board Bill of Materials

| Designator | Quantity | Description | Manufacturer | Footprint | Part Number |
|----------------|----------|--|--------------|---|--------------------|
| C1.1 | 0 | Ceramic chip, 22 μ F, 25 V, \pm 20%, X5R | Panasonic | 1210 | ECJ4YB1E226M |
| C1.2, C1.3 | 2 | Aluminum electrolytic capacitor, 25 V / 47 μ F | Rubycon | 8 mm \times 12 mm | EEVFC1H470P |
| C2 | 1 | Ceramic capacitor, X7R, \pm 10%, 0.1 μ F / 50 V | Murata | 0603 | GRM188R71H104KA93D |
| C3 | 1 | Ceramic capacitor, X7R, \pm 10%, 0.01 μ F / 50 V | Kemet | 0603 | C0603C103K5RACTU |
| C4.2 | 0 | Special polymer capacitor, 120 μ F / 6.3 V, 15 m Ω | Panasonic | 7.3 mm \times 4.3 mm \times 3.1 mm | EEFUD0J121R |
| C4.1 | 0 | Ceramic capacitor, 47 μ F / 6.3 V, \pm 20%, X5R | Panasonic | 1210 | ECJ4YB0J476M |
| C4.3 | 1 | Aluminum electrolytic capacitor, 35 V / 150 μ F, 56 m Ω | Panasonic | 8 mm \times 10.2 mm | EEMFM1V151 |
| L1 | 1 | Inductor, 3.8 μ H, 13 m Ω , 6 A, \pm 20% | Sumida | 10.3 mm \times 10.5 mm \times 4 mm | CDRH104R-3R8 |
| D1 | 1 | Schottky diode, 20 V / 4.0 A | Diodes, Inc. | SMA | SL42-9C |
| R1 | 1 | Chip resistor, 1/16 W, 1% | Std. | 0603 | Std. |
| | | 2 k Ω at $V_{OUT} = 1.06$ V | | | |
| | | 2.55 k Ω at $V_{OUT} = 1.8$ V | | | |
| | | 6.34 k Ω at $V_{OUT} = 3.3$ V | | | |
| | | 10.5 k Ω at $V_{OUT} = 5.0$ V | | | |
| R2 | 1 | Chip resistor, 1/16W, 1% | Std. | 0603 | Std. |
| | | 6.14 k Ω at $V_{OUT} = 1.06$ V | | | |
| | | 2 k Ω at $V_{OUT} = 1.8, 3.3, \text{ or } 5.0$ V | | | |
| R3 | 1 | Chip resistor, 51.1 k Ω , 1/16 W, 1% | Std. | 0603 | Std. |
| R4 | 1 | Chip resistor, 10 k Ω , 1/16 W, 1% | Std. | 0603 | Std. |
| R5 | 1 | Chip resistor, 0 Ω , 1/16 W, 1% | Std. | 0603 | Std. |
| J1, J2, J3, J4 | 4 | Header, 2-pin, 100 mil spacing | Sullins | 0.100 in. \times 2 | PTC36SAAN |
| P1 | 1 | Test point, Red, 1 mm | Farnell | 0.038 in. | 240-345 |
| EN | 1 | Test point, Black, 1 mm | Farnell | 0.038 in. | 240-333 |
| U1 | 1 | Wide Input Voltage Step Down Regulator | Allegro | ESOIC8 | A8697 |

Package LJ 8-Pin SOIC

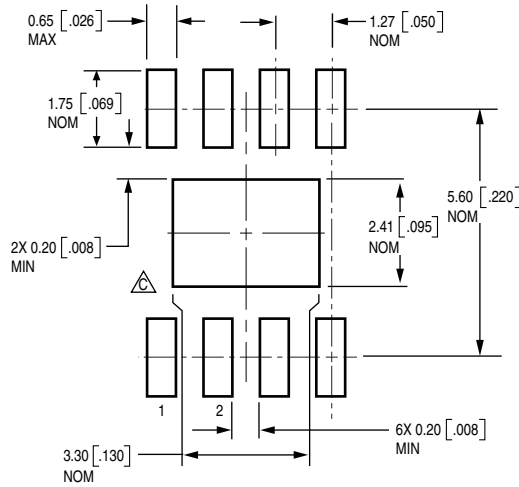
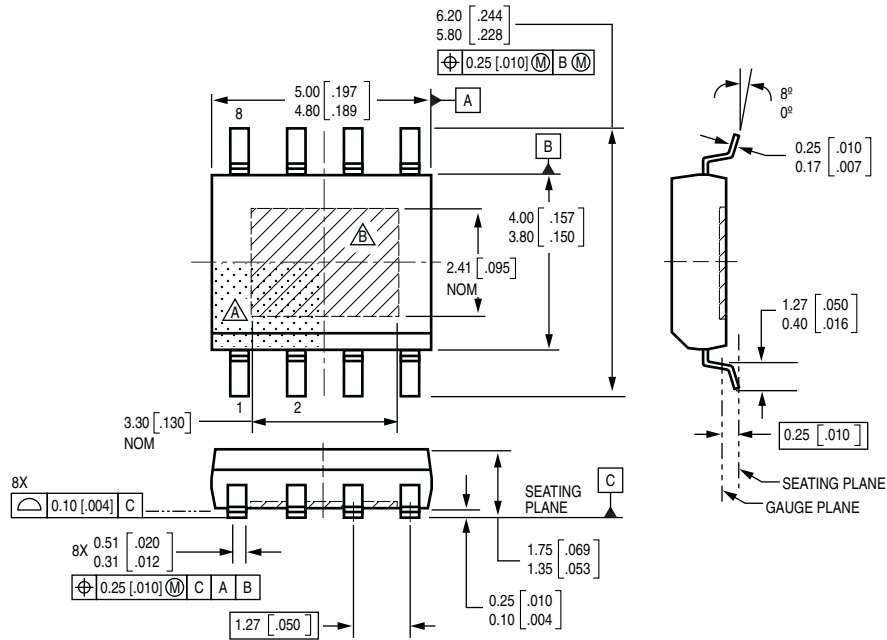

All dimensions reference, not for tooling use
 (reference JEDEC MS-012 AA)
 Dimensions in millimeters
 U.S. Customary dimensions (in.) in brackets, for reference only
 Dimensions exclusive of mold flash, gate burrs, and dambar protrusions
 Exact case and lead configuration at supplier discretion within limits shown

⚠ Terminal #1 mark area
 ⚠ Exposed thermal pad (bottom surface)
 ⚠ Reference land pattern layout (reference IPC7351 SOIC127P600X175-9AM); adjust as necessary to meet application process requirements and PCB layout tolerances; when mounting on a multilayer PCB, thermal vias at the exposed thermal pad land can improve thermal dissipation (reference EIA/JEDEC Standard JESD51-5)

Pin-out Diagram

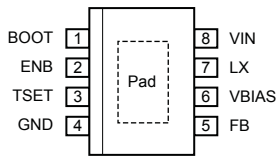

(Top View)

Terminal List Table

| Number | Name | Description |
|--------|-------|--|
| 1 | BOOT | Gate drive boost node |
| 2 | ENB | On/off control; logic input |
| 3 | TSET | Off-time setting |
| 4 | GND | Ground |
| 5 | FB | Feedback for adjustable regulator |
| 6 | VBIAS | Bias supply input |
| 7 | LX | Buck switching node |
| 8 | VIN | Supply input |
| - | Pad | Exposed pad for enhanced thermal dissipation |

The products described herein are manufactured under one or more patents pending.

Allegro MicroSystems, Inc. reserves the right to make, from time to time, such departures from the detail specifications as may be required to permit improvements in the performance, reliability, or manufacturability of its products. Before placing an order, the user is cautioned to verify that the information being relied upon is current.

Allegro products are not authorized for use as critical components in life-support appliances, devices, or systems without express written approval.

The information included herein is believed to be accurate and reliable. However, Allegro MicroSystems, Inc. assumes no responsibility for its use; nor for any infringements of patents or other rights of third parties that may result from its use.

Copyright © 2006 Allegro MicroSystems, Inc.

