

6.5 Watt Ku Band Power Amplifier

TGA2514-FL

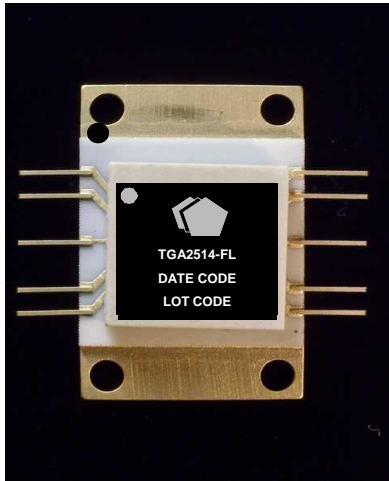

Key Features

- Frequency Range: 13 - 16 GHz
- 38 dBm Nominal Psat
- 24 dB Nominal Gain
- 14 dB Nominal Return Loss
- 0.25-um pHEMT 3MI Technology
- 10 lead flange package
- Bias Conditions: 8 V @ 2.6 A Idq
- Package dimension: 0.45 x 0.68 x 0.12 in.

Primary Applications

- Ku band VSAT Transmitter
- Point to Point Radio

Product Description

The TGA2514-FL provides 24 dB of gain and 6.5W of output power across 13-16 GHz. The TGA2514-FL is designed using TriQuint's proven standard 0.25- μ m gate pHEMT production process.

This device is ideally suited for VSAT Transmitter and Point to Point Radio applications. The flange lead package has a high thermal conductivity copper alloy base.

Lead-Free & RoHS compliant

Evaluation Boards are available.

Measured Data

Bias Conditions: $V_d = 8\text{ V}$, $I_{dq} = 2.6\text{ A}$

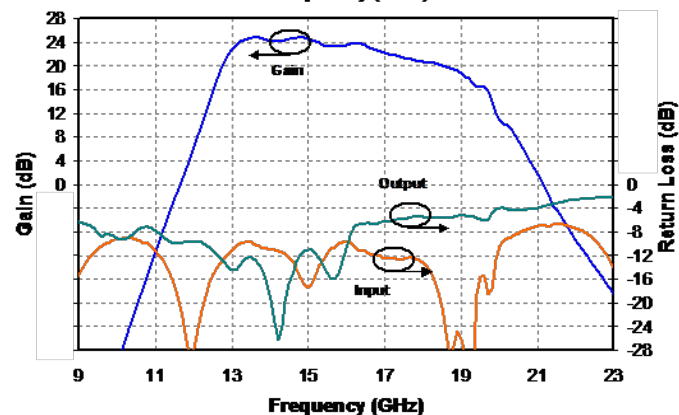
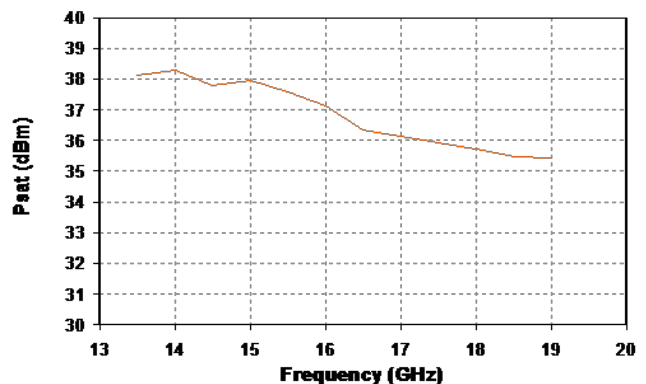

Datasheet subject to change without notice.

TABLE I
Absolute Maximum Ratings 1/

Symbol	Parameter	Value	Notes
V+	Positive Supply Voltage	9 V	<u>2/</u>
V-	Negative Supply Voltage Range	-5V TO 0V	
I _d	Drain Current	3.8 A	<u>2/</u>
I _g	Gate Current Range	-18 to 18 mA	
P _{in}	Input Continuous Wave Power	21 dBm	<u>2/</u>
T _{channel}	Channel Temperature	200 °C	

1/ These ratings represent the maximum operable values for this device. Stresses beyond those listed under “Absolute Maximum Ratings” may cause permanent damage to the device and/or affect device lifetime. These are stress ratings only, and functional operation of the device at these conditions is not implied.

2/ Combinations of supply voltage, supply current, input power, and output power shall not exceed maximum power dissipation listed in Table IV.

TABLE II
RF CHARACTERIZATION TABLE
 (T_A = 25°C, Nominal)
 (V_d = 8V, I_d = 2.6 A)

SYMBOL	PARAMETER	TEST CONDITION	TYPICAL	UNITS
Gain	Small Signal Gain	f = 13-16 GHz	24	dB
IRL	Input Return Loss	f = 13-16 GHz	14	dB
ORL	Output Return Loss	f = 13-16 GHz	14	dB
Psat	Saturated Power	f = 13-16 GHz	38	dBm

TABLE III
Power Dissipation and Thermal Properties

Parameter	Test Conditions	Value
Maximum Power Dissipation	Tbaseplate = 70	Pd = 33.3 W Tchannel = 200 °C
Thermal Resistance, θ_{jc}	Vd = 8V Id = 2.6 A Pd = 20.8 W	θ_{jc} = 3.9 °C/W Tchannel = 151 °C Tm = 9.3E5 hrs
Thermal Resistance, θ_{jc} Under RF Drive	Vd = 8 V Id = 3.6 A Pout = 38 dBm Pd = 22.5 W	θ_{jc} = 3.9 °C/W Tchannel = 158 °C Tm = 5.2E5 hrs
Mounting Temperature	30 Seconds	320 °C
Storage Temperature		-65 to 150 °C

Median Lifetime (Tm) vs. Channel Temperature (Tch)

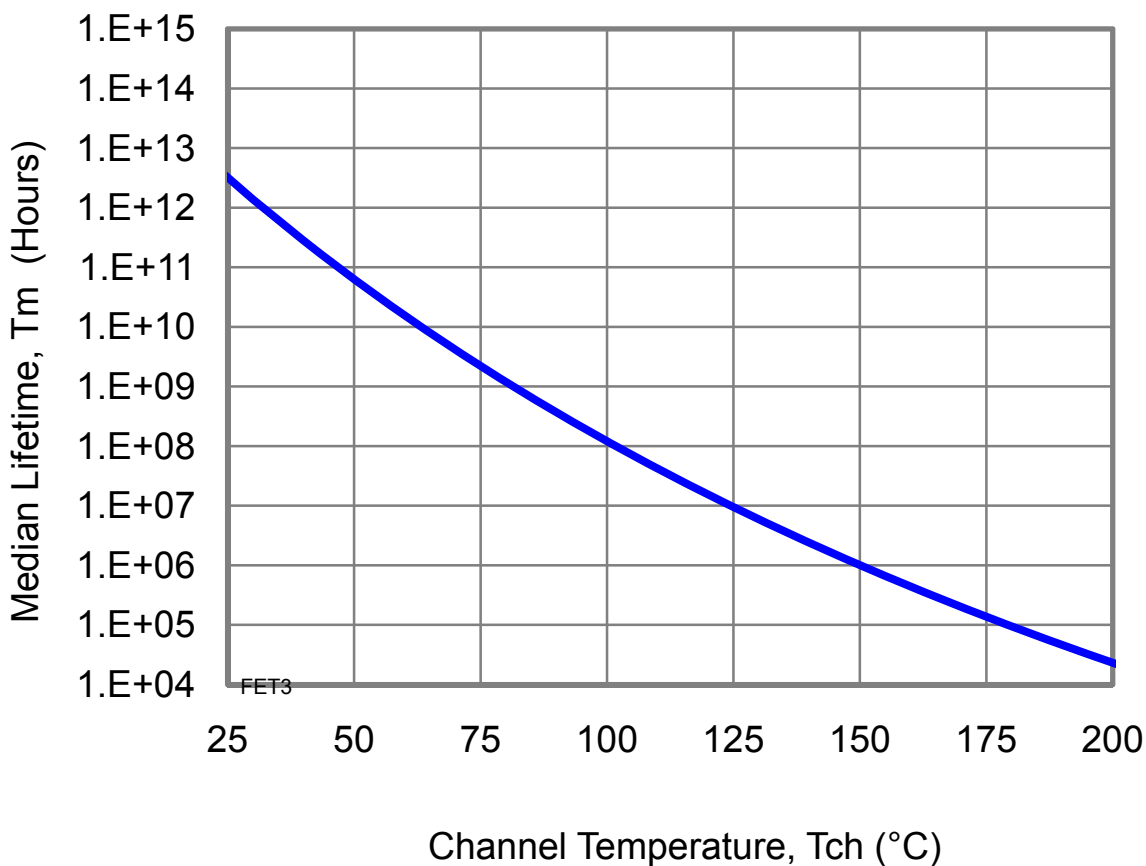

Measured Fixture Data

Bias Conditions: $V_d = 8\text{ V}$, $I_{dq} = 2.6\text{ A}$

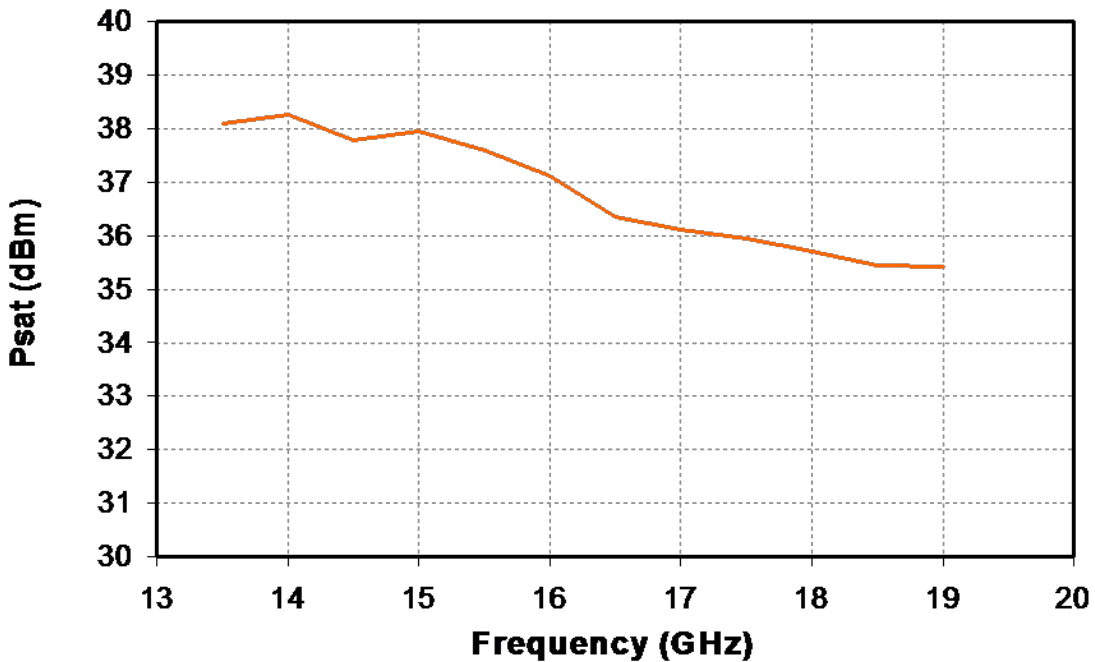
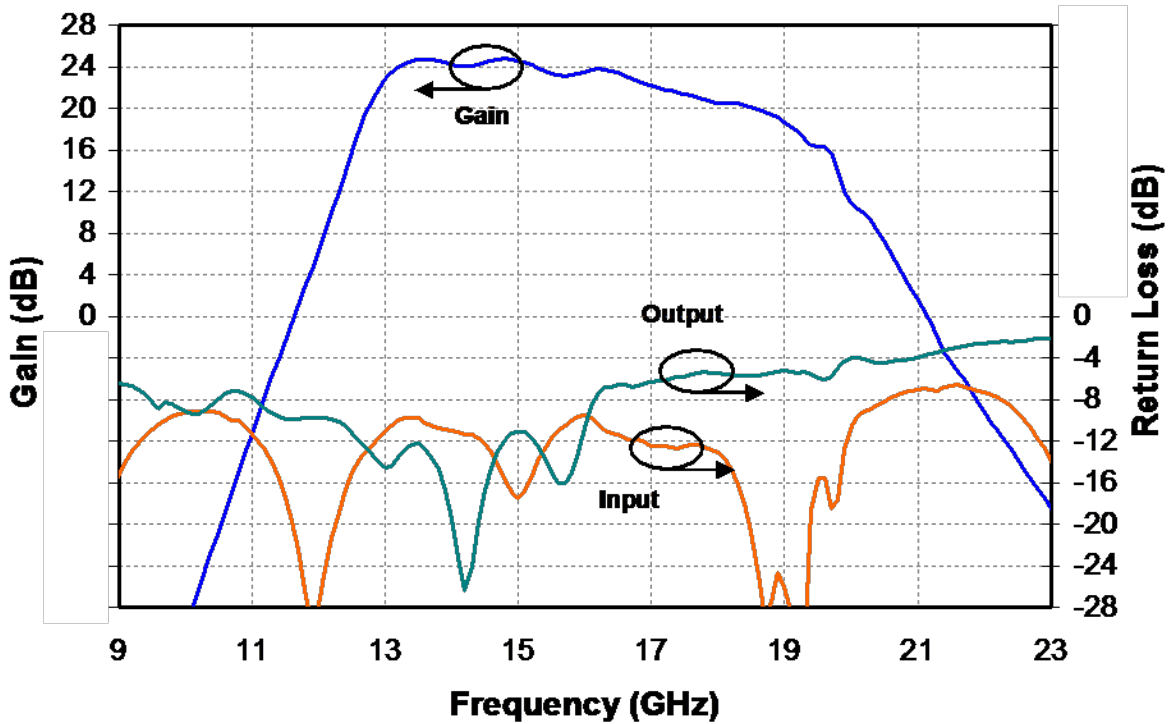

Measured Fixture Data

Bias Conditions: $V_d = 8\text{ V}$, $I_{dq} = 2.6\text{ A}$

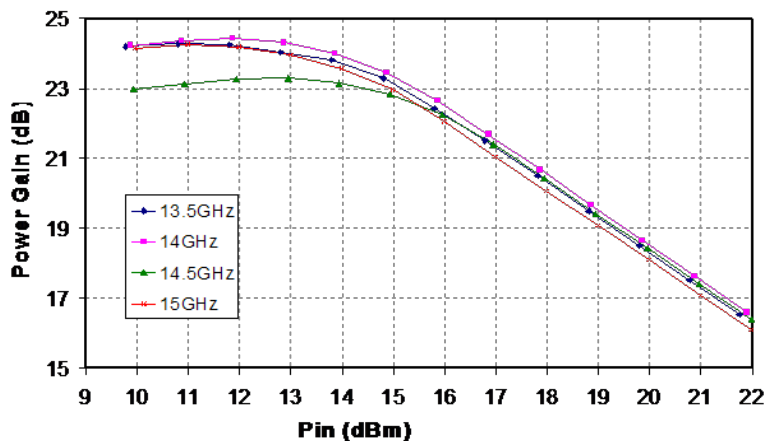
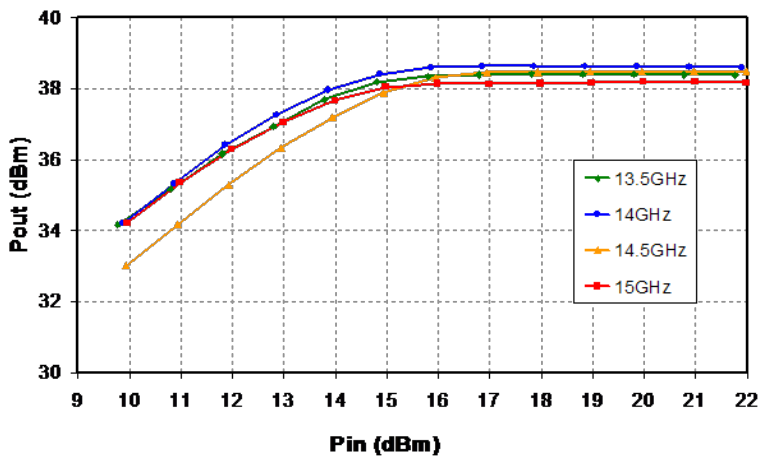
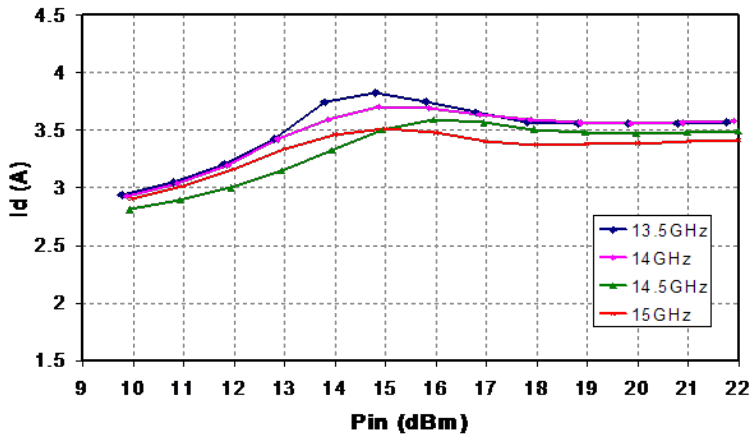

Measured Fixture Data

Bias Conditions: $V_d = 8\text{ V}$, $I_{dQ} = 2.6\text{ A}$

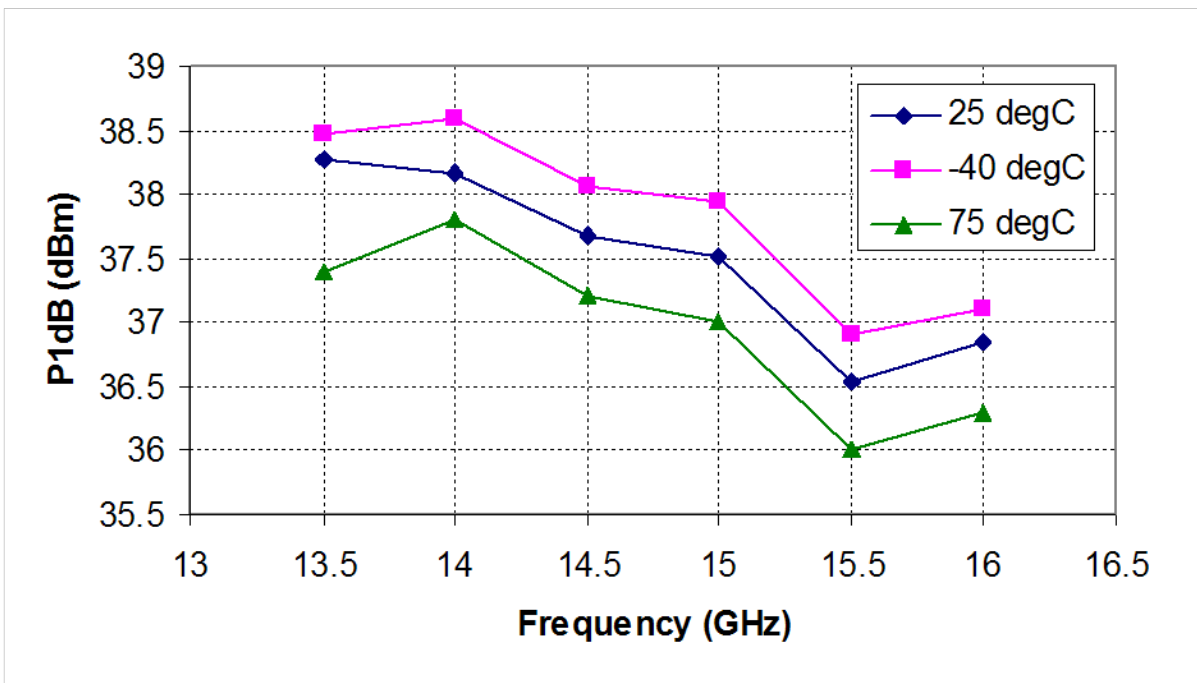
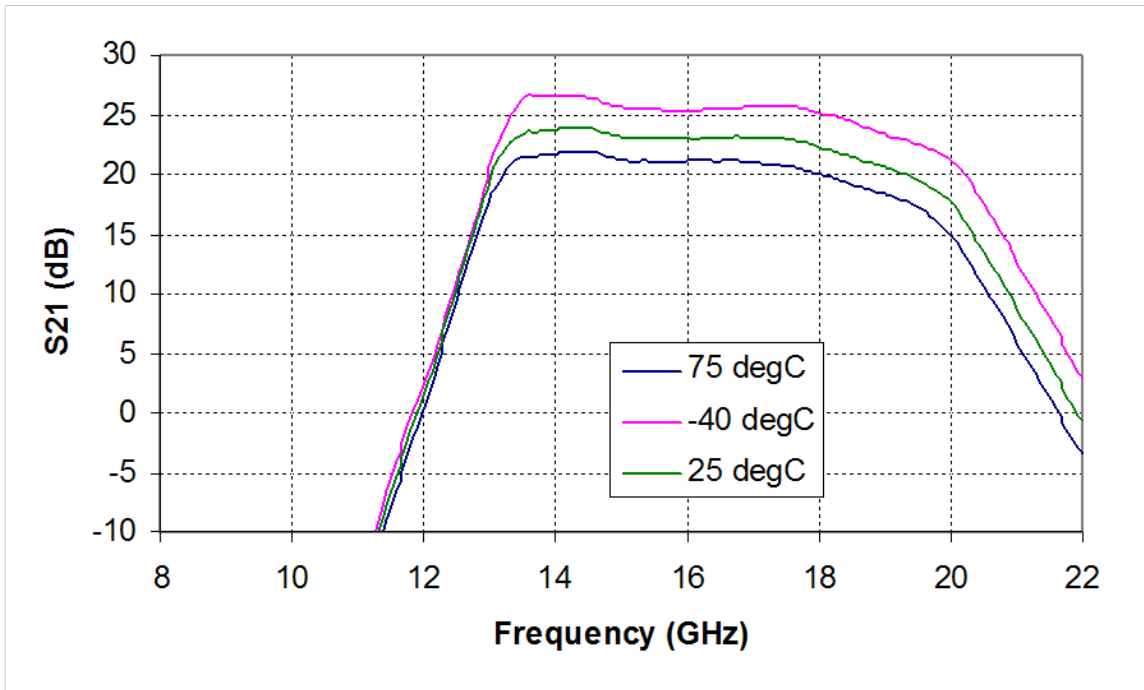

Evaluation Board

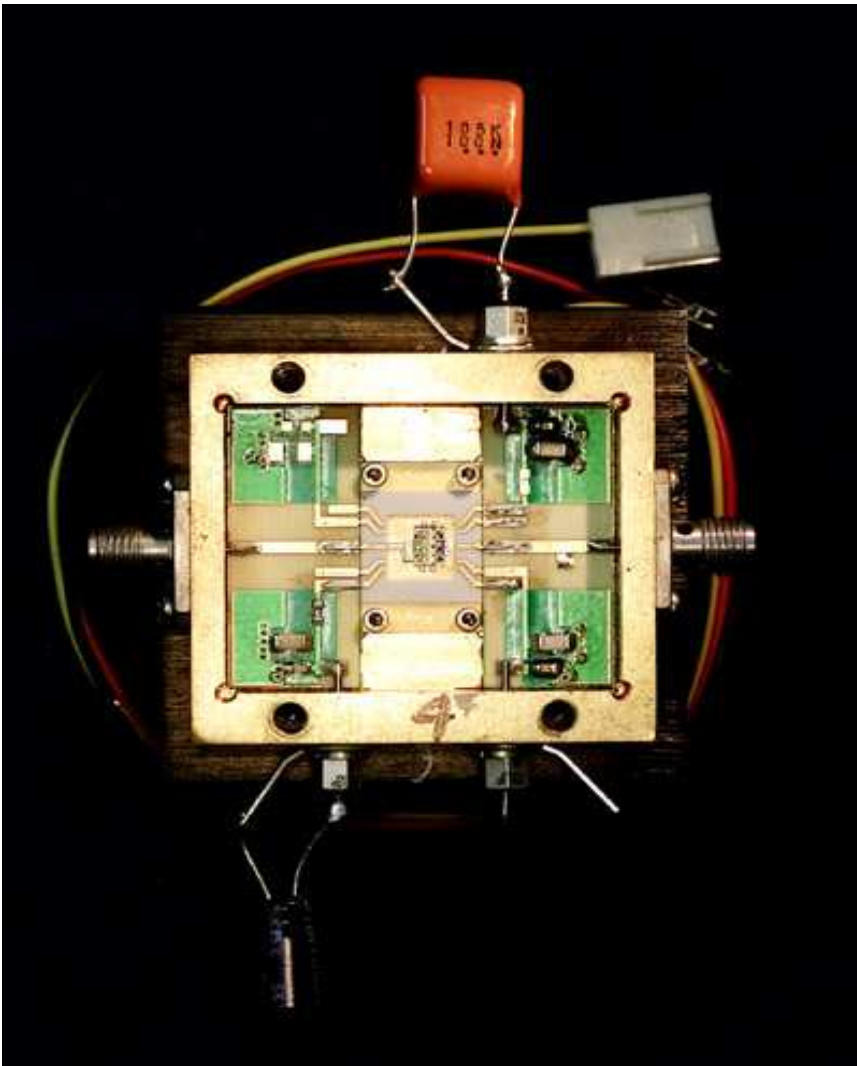

Notes:

1. V_d must remain below 9V to comply with maximum rating value.
2. The drain supply must be connected to both sides of the evaluation block.
3. The cooling fan must be powered at all times when the device is under bias.
4. Connect fan supply red/black to +12V. It requires ~100mA.

Assembly Diagram

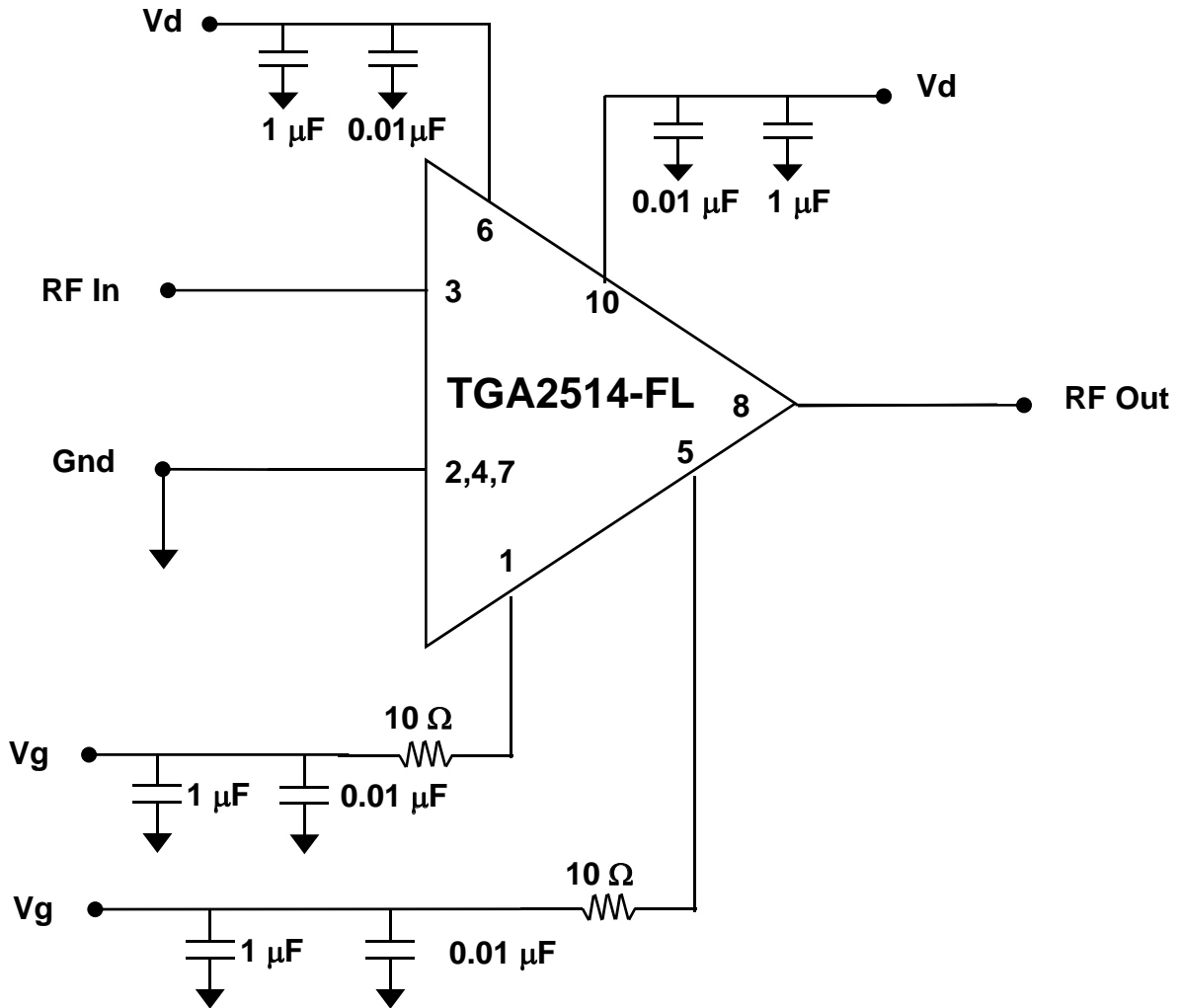

Note: Vg can be biased from either Pin 1 or Pin 5

Mechanical Drawing TGA2514-FL

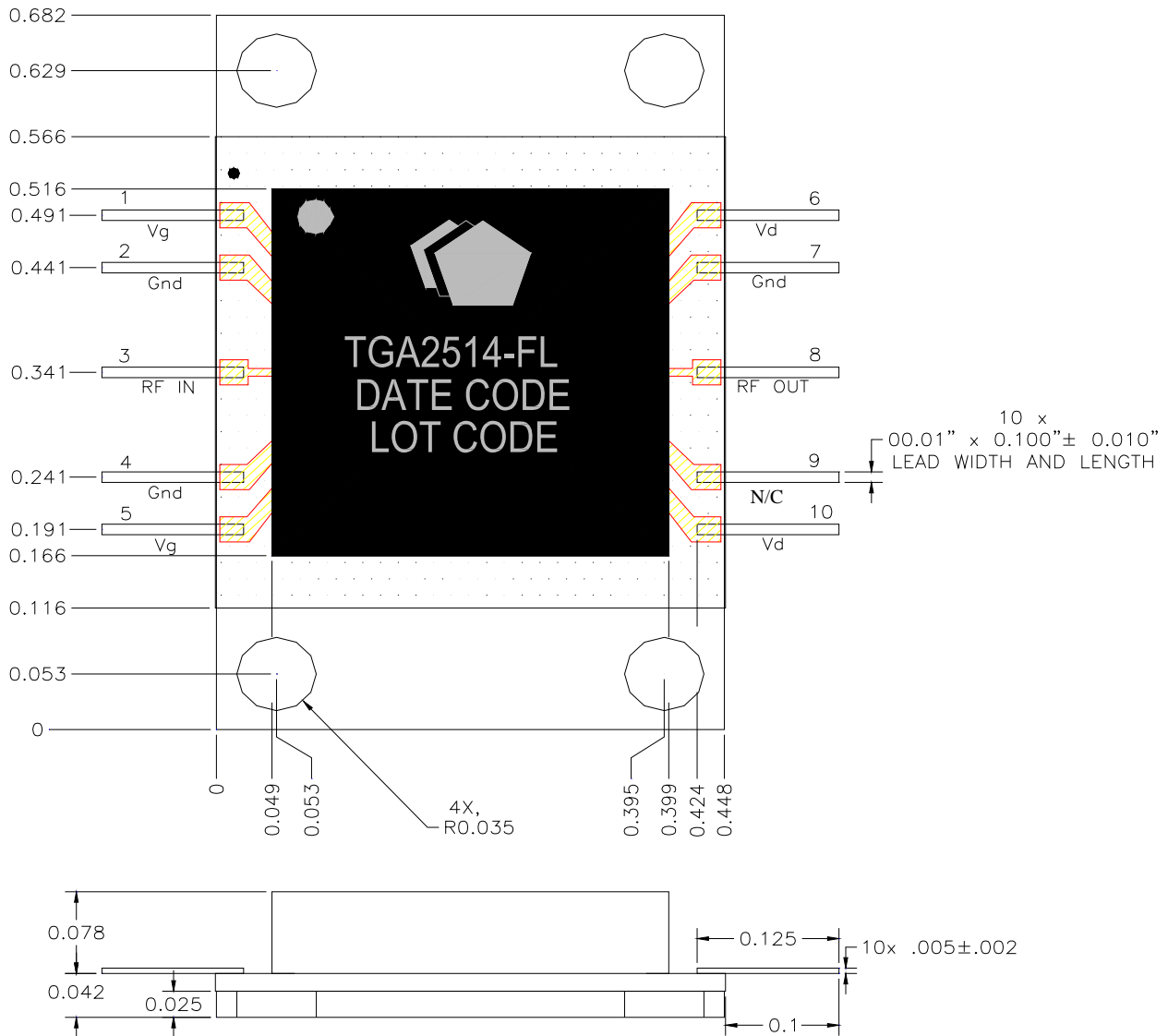

Note: All dimensions are in inches with ±0.005 tolerance

Assembly of a TGA2514-FL Package

1. Clean the board or module with acetone. Rinse with alcohol and DI water. Allow the circuit to fully dry.
2. To improve the thermal and RF performance, we recommend attaching a heat sink to the bottom of the package and applying Indium alloy shim (80IN,15PB and 5AG. Part # IPN 10061) to the bottom of TGA2514-FL.
3. Apply solder to each pin of TGA2514-FL.
4. Clean the assembly with alcohol.

Ordering Information

Part	Package Style
TGA2514-FL	Flange (package bolted down)