

# TGA2807-SM

## CATV Ultra Linear Gain Amplifier



### Applications

- CATV EDGE QAM Cards
- CMTS Equipment



28-pin 5x5 mm QFN Package

### Product Features

- 40-1000 MHz Bandwidth
- DOCSIS 3.0 Compliant
- ACPR: -69 dBc at 61 dBmV Pout
- Pdiss: 1.9 W
- 18.5 dB Typical Gain
- 28 dBm P<sub>SAT</sub>
- 2.3 dB typical noise figure
- 20 dB Typical Output Return Loss
- 6 V Single Supply
- 318 mA Current Draw
- 5 x 5 mm QFN Package

### General Description

The TriQuint TGA2807-SM is an ultra-linear packaged Gain Block which operates from 40 MHz to 1 GHz.

The TGA2807-SM provides flat gain along with ultra-low distortion. It also provides high output power with low DC power consumption.

This amplifier is ideally suited for use in CATV headend systems or other applications requiring low noise and low distortion.

Demonstration Boards are available.

Lead-free and RoHS compliant.

### Functional Block Diagram

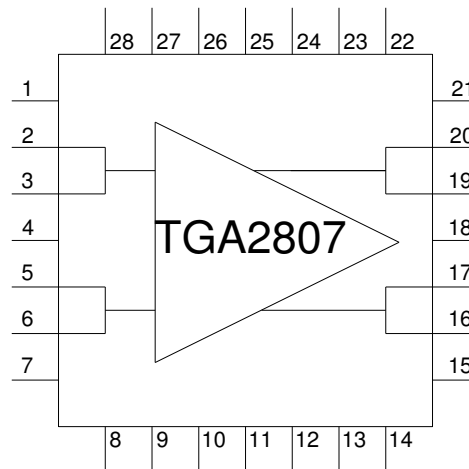

### Pin Configuration

Pin #	Symbol
2, 3	RF Input 1
5, 6	RF Input 2
9, 27, 29	Ground
10	VG2 (Optional)
11, 25	Voltage Supply
12, 24	Voltage Supply (Choked)
13	Current Sense
16, 17	RF Output 2
19, 20	RF Output 1
26	VG1 (Optional)
1, 4, 7, 8, 14, 15, 18, 21, 22, 23, 28	No Connect
29	Ground Slug

### Ordering Information

Part No.	Description
TGA2807-SM	CATV Ultra Linear Gain Amplifier (lead-free/RoHS compliant 5x5 QFN Pkg)

Standard T/R size = 1000 pieces on a 7" reel.

### Specifications

#### Absolute Maximum Ratings<sup>1</sup>

Parameter	Rating
Device Voltage	+11.0 V
Continuous Input Power	73.8 dBmV
Storage Temperature	-65 to +150 °C
Operating Temperature	-40 to 85 °C

Operation of this device outside the parameter ranges given above may cause permanent damage.

#### Recommended Operating Conditions

Parameter	Min	Typ	Max	Units
V <sub>DD</sub>	6	7	7.5	V
I <sub>DD</sub>	240	318	380	mA
V <sub>G1</sub>		0.95		V
V <sub>G2</sub>		2.65		V
T <sub>J</sub> (for > 10 <sup>6</sup> hours MTTF)			150	°C

Electrical specifications are measured at specified test conditions. Specifications are not guaranteed over all recommended operating conditions

#### Electrical Specifications

Test conditions unless otherwise noted: 25 °C, +6 V V<sub>DD</sub>

Parameter	Conditions	Min	Typical	Max	Units
Operational Frequency Range		40		1000	MHz
Gain	Note 9	17	18.5	22	dB
Gain Flatness	Note 1		±0.5		dB
Noise Figure	Note 2	1.9	2.4	4.0	dB
Input Return Loss		10	15		dB
Output Return Loss		10	20		dB
Output IP3 (150 MHz)	Note 3		43		dBm
I <sub>DD</sub>	Note 9	240	318	380	mA
P <sub>SAT</sub>	Note 4		28		dBm
ACPR	Notes 5, 8, 9		-69	-63.5	dBc
Harmonics (2 <sup>nd</sup> – 4 <sup>th</sup> )	Note 6		-69		dBc
Thermal Resistance (jnt to case) θ <sub>jc</sub>	Note 7		16.7		°C/W

Notes:

- Flatness determined by deviation from a straight-line curve fit across the entire band
- At 500 MHz
- At 15 dBm output power per tone
- Measured at 750 MHz
- Using single channel 256-QAM at 858 MHz and 61 dBmV output power, measured in the band 750 kHz from channel block edge to 6 MHz from channel block edge
- Using quad 256-QAM channels at 54 dBmV output power per channel
- Refer to Thermal Analysis Report TGA2807
- ACPR degrades at as V<sub>DD</sub> less than 7.0 V
- Tested in production

# TGA2807-SM

## CATV Ultra Linear Gain Amplifier



### Application Circuit Reference Design 40-1000 MHz

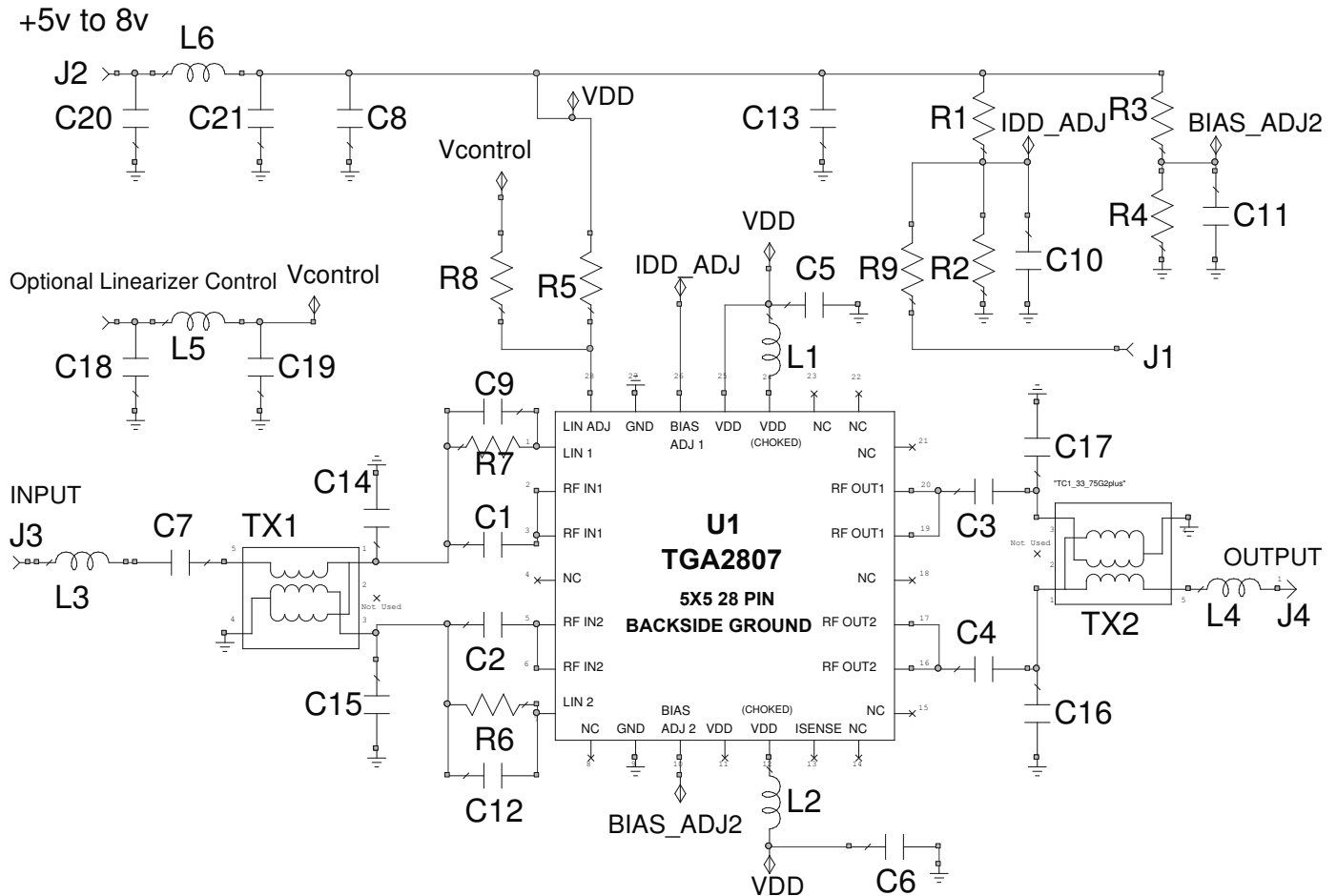

# TGA2807-SM

## CATV Ultra Linear Gain Amplifier



### Application Circuit BOM 40-1000 MHz

#### Bill of Materials

Ref Des	Value	Description	Manufacturer	Part Number
U1	--	TGA2807-SM 40MHz-1GHz, CATV Gain Block	TriQuint	
C1, C2, C5, C6, C7, L4	0.01uF	Ceramic Cap, 0402, NPO, 16V	Various	
C3, C4	470pF	Ceramic Cap, 0402, 16V, 10%	Various	
C8, C13, C20, C21	0.1uF	Ceramic Cap, 0603, 16V, 10%	Various	
TX1, TX2	1:1	75Ω , 1:1Transformer	MiniCircuits	TC1-33-75G2+
L1, L2	560nH	Ind, ferrite, 0603, 530 mA, 5%	Coilcraft	0603AF-561XJR
L3	0Ω	Res, Chip, 0402		
L6	0.9uH	Ind, Chip, 1008, 5%, 1.4A	Coilcraft	1008AF-901XJLB
R1, R2, R3, R4, R5, R6, R7, R8, R9, C9, C10, C11, C12,C14, C15, C16, C17, C18, C19, L5	DNP	Do Not Place		

\*Note, BOM is based on the minimal design. Additional loads for appropriate bias adjustments.

# TGA2807-SM

## CATV Ultra Linear Gain Amplifier

### Layout Drawing

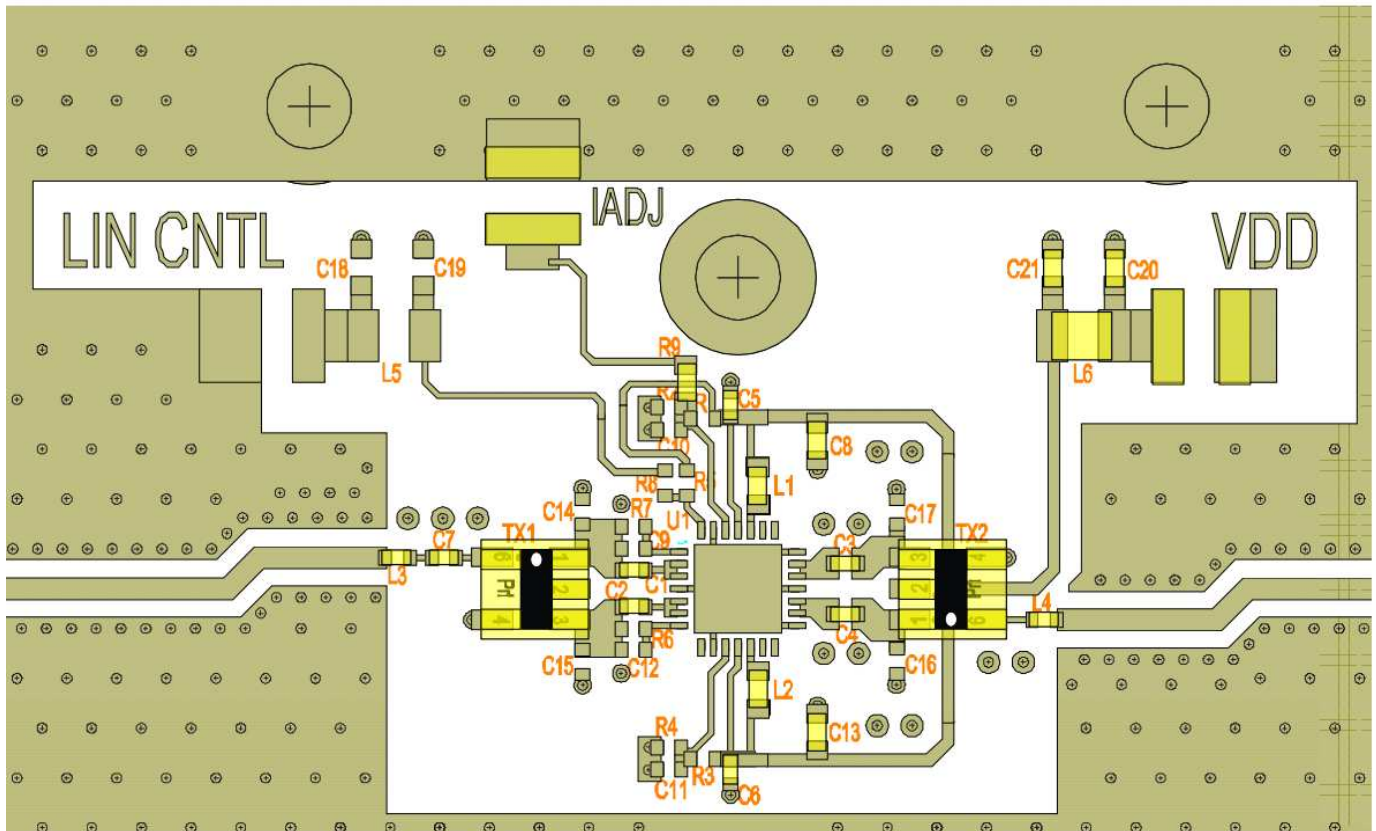

# TGA2807-SM

## CATV Ultra Linear Gain Amplifier



### 50-1000 MHz Application Board Typical Performance

$V_{DD} = +6\text{ V}$ ,  $I_{DD} = 318\text{ mA}$ ,  $75\ \Omega$ , 83 channels,  $25\ ^\circ\text{C}$ , App Circuit for TGA2807

Return Loss

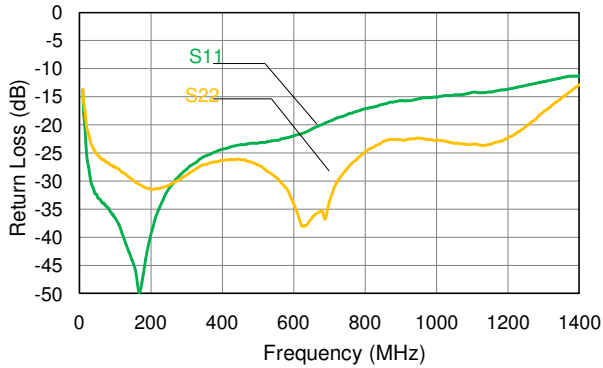

Gain

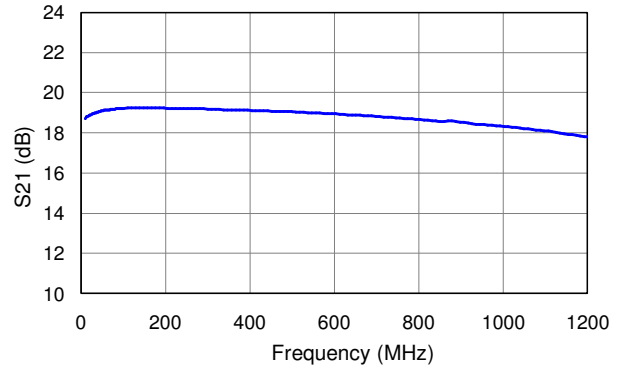

Noise Figure

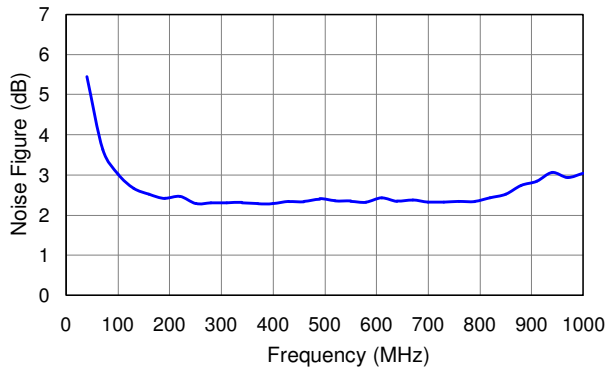

XMD

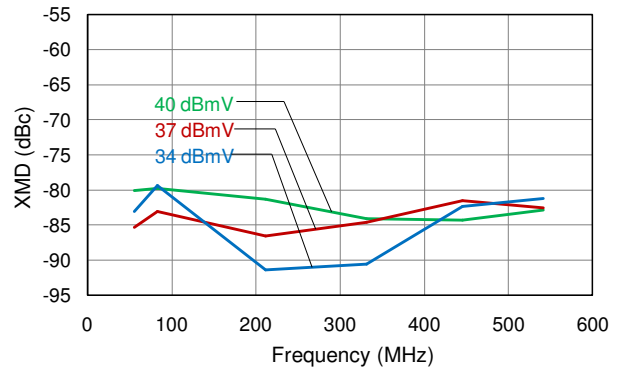

CTB

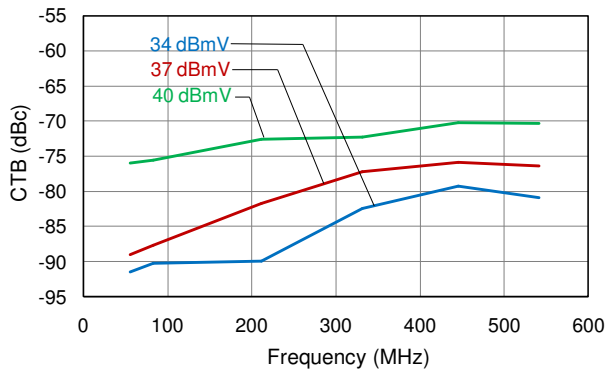

CSO

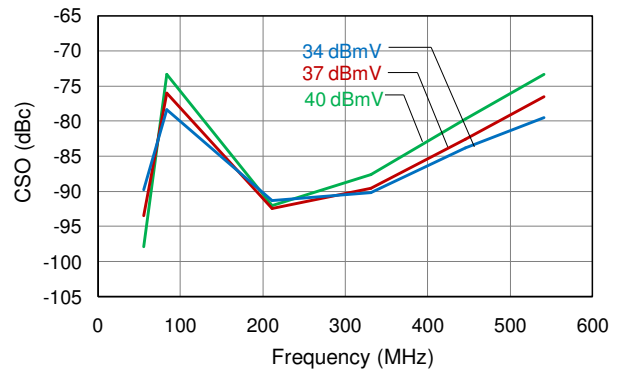

# TGA2807-SM

## CATV Ultra Linear Gain Amplifier



### 50-1000 MHz Application Board Typical Performance

75  $\Omega$ , single 256-QAM channel

ACPR vs  $P_{OUT}$  and  $V_{DD}$

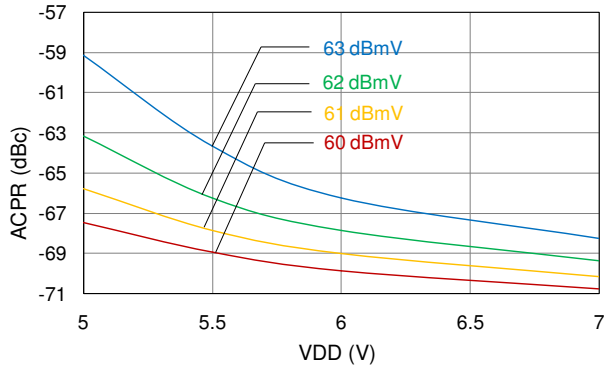

ACPR vs  $V_{DD}$  vs Temp

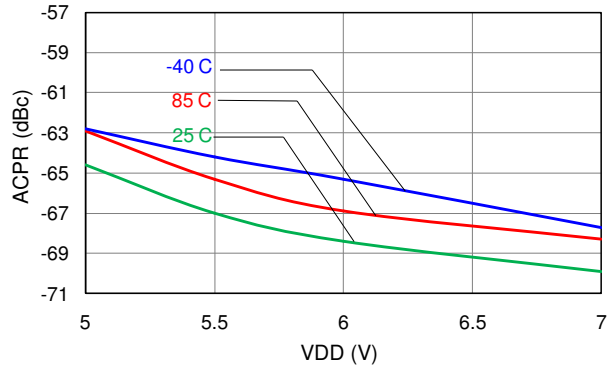

ACPR & Gain

$V_{DD} = 5.5 \text{ V}$ ,  $P_{OUT} = 61 \text{ dBmV}$

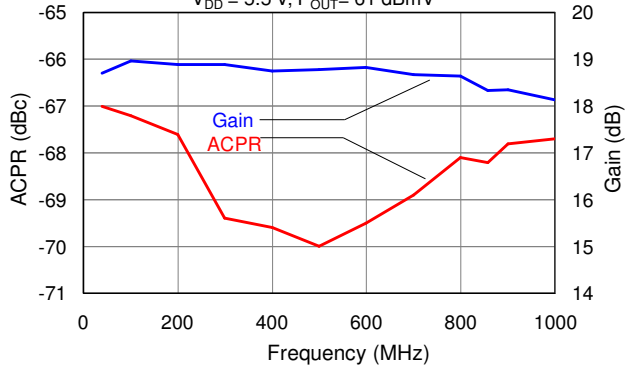

ACPR & Gain

$V_{DD} = 6 \text{ V}$ ,  $P_{OUT} = 62 \text{ dBmV}$

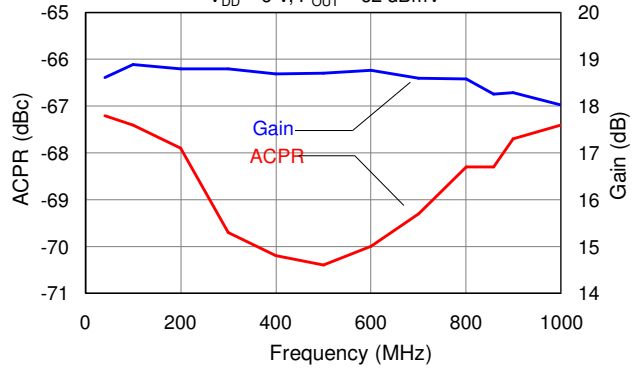

DC Power and  $V_{DD}$  to Maintain -66 dBC ACPR

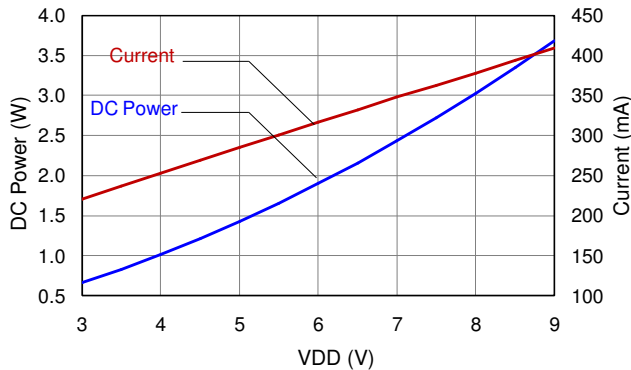

$P_{OUT}$  and  $V_{DD}$  to Maintain -66 dBC ACPR

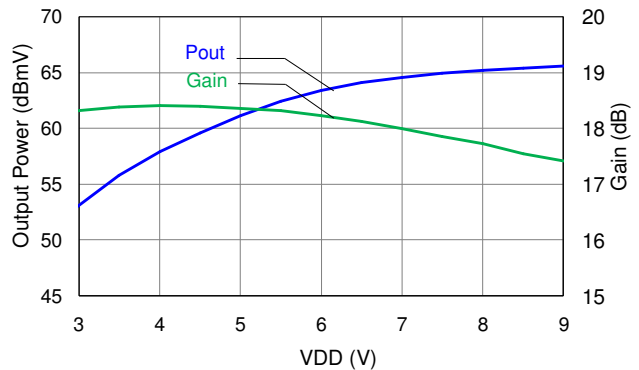

# TGA2807-SM

## CATV Ultra Linear Gain Amplifier



### Mechanical Information

#### Package Information and Dimensions

This package is lead-free/RoHS-compliant. The plating material on the leads is 100 % Matte Tin. It is compatible with both lead-free (maximum 260 °C reflow temperature) and lead (maximum 245 °C reflow temperature) soldering processes.

The TGA2807 will be marked with a “2807” designator and 2 lines of 4 digit alphanumeric lot code (YYWW on the second line, and XXXX on the third). The first four digits are a date code consisting of the year and work week (YYWW) of assembly. The last four digits are the lot code (XXXX).

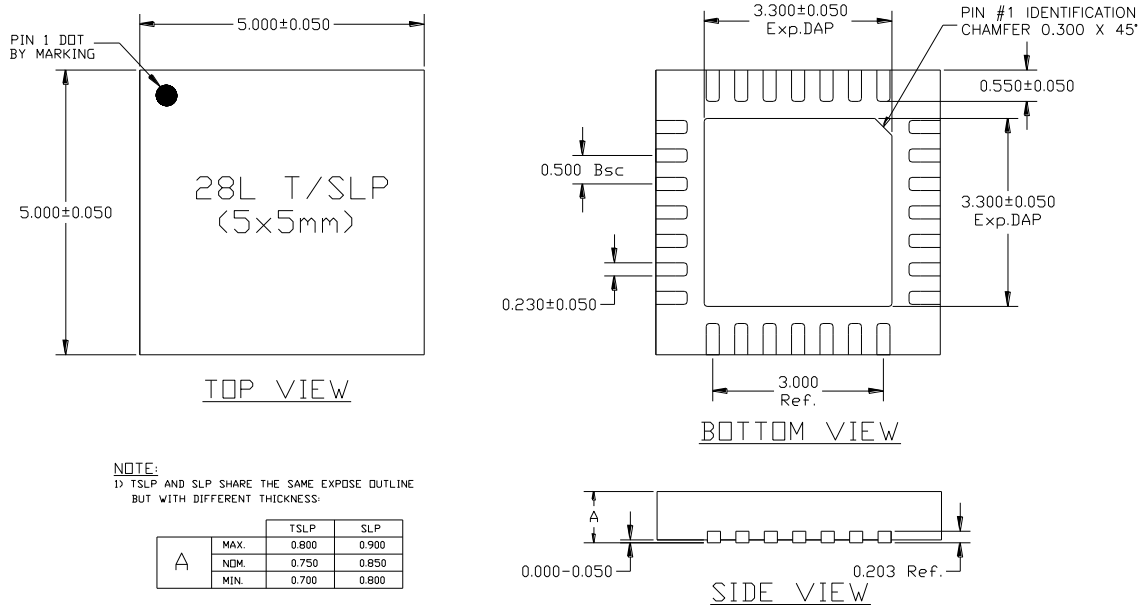

#### Mounting Configuration

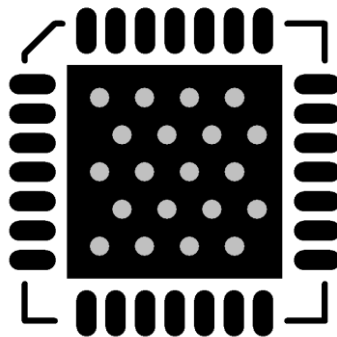

**Notes:**

1. Ground / thermal vias are critical for the proper performance of this device. Vias should use a .35mm (#80/.0135”) diameter drill and have a final, plated thru diameter of .25 mm (.010”).
2. Add as much copper as possible to inner and outer layers near the part to ensure optimal thermal performance.
3. RF trace width depends upon the PC board material and construction.
4. All dimensions are in millimeters (inches). Angles are in degrees.



# TGA2807-SM

## CATV Ultra Linear Gain Amplifier

### Product Compliance Information

#### ESD Information



#### Caution! ESD-Sensitive Device

ESD Rating: Class 1 A

Value: Passes  $\geq 450$  V min.

Test: Human Body Model (HBM)

Standard: JEDEC Standard JESD22-A114

For additional guidance regarding ESD and surge protection, please consult with Application Engineering.

#### Solderability

Compatible with the latest version of J-STD-020, Lead free solder, 260 °C.

This part is compliant with EU 2002/95/EC RoHS directive (Restrictions on the Use of Certain Hazardous Substances in Electrical and Electronic Equipment).

#### MSL Rating

The part is rated Moisture Sensitivity Level 1 at 260°C per JEDEC standard IPC/JEDEC J-STD-020.

# TGA2807-SM

## *CATV Ultra Linear Gain Amplifier*



### Contact Information

For the latest specifications, additional product information, worldwide sales and distribution locations, and information about TriQuint:

**Web:** [www.triquint.com](http://www.triquint.com)  
**Email:** [info-sales@tqs.com](mailto:info-sales@tqs.com)

**Tel:** +1.707.526.4498  
**Fax:** +1.707.526.1485

For technical questions and application information:

**Email:** [sjapplications.engineering@tqs.com](mailto:sjapplications.engineering@tqs.com)

### Important Notice

The information contained herein is believed to be reliable. TriQuint makes no warranties regarding the information contained herein. TriQuint assumes no responsibility or liability whatsoever for the use of the information contained herein. The information contained herein is provided "AS IS, WHERE IS" and with all faults, and the entire risk associated with such information is entirely with the user. All information contained herein is subject to change without notice. Customers should obtain and verify the latest relevant information before placing orders for TriQuint products. The information contained herein or any use of such information does not grant, explicitly or implicitly, to any party any patent rights, licenses, or any other intellectual property rights, whether with regard to such information itself or anything described by such information.

TriQuint products are not warranted or authorized for use as critical components in medical, life-saving, or life-sustaining applications, or other applications where a failure would reasonably be expected to cause severe personal injury or death.