

## K Band High Power Amplifier

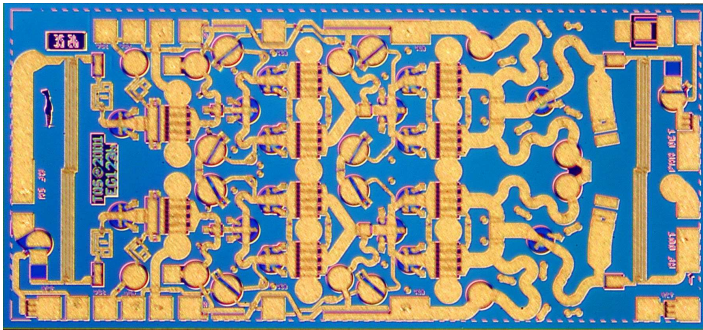

### Key Features

- 17-27 GHz Application Frequency Range
- 22 dB Nominal Gain
- 29 dBm Nominal P1dB
- 37 dBm Nominal OTOI
- 15 dB Nominal Return Loss
- 0.25 um pHEMT 2MI Technology
- Bias 7 V @ 760 mA
- Chip Dimensions 1.52 x 3.29 x 0.1 mm

### Product Description

The TriQuint TGA4502-SCC is a compact High Power Amplifier MMIC for K-band applications. The part is designed using TriQuint's proven standard 0.25 um gate power pHEMT production process.

The TGA4502-SCC provides a nominal 29 dBm of output power at 1 dB gain compression from 17-27 GHz with a small signal gain of 22 dB.

The part is ideally suited for low cost emerging markets such as K-band Satellite Communications, Point-to-Point Radio, and Point-to-Multi Point Communications.

The TGA4502-SCC is 100% DC and RF tested on-wafer to ensure performance compliance.

### Primary Applications

- K Band Sat-Com
- Point-to-Point Radio
- Point-to-Multipoint Communications

### Fixtured Measured Performance

Bias Conditions:  $V_d = 7\text{ V}$ ,  $I_d = 760\text{ mA}$

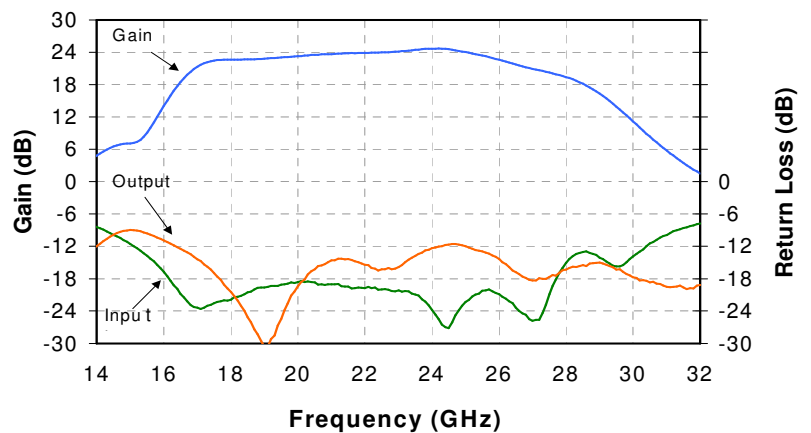
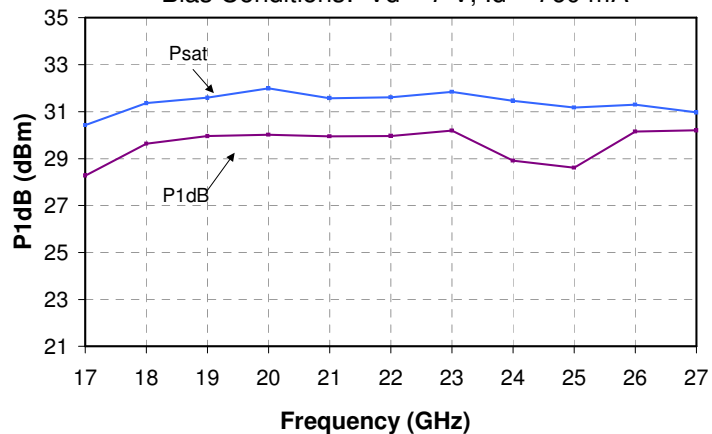

**TABLE I**  
**ABSOLUTE MAXIMUM RATINGS 1/**

<b>SYMBOL</b>	<b>PARAMETER</b>	<b>VALUE</b>	<b>NOTES</b>
V <sup>+</sup>	Positive Supply Voltage	8 V	<u>2/</u>
V <sup>-</sup>	Negative Supply Voltage Range	-5V TO 0V	
I <sup>+</sup>	Positive Supply Current	1100 mA	<u>2/</u>
I <sub>G</sub>	Gate Supply Current	28 mA	
P <sub>IN</sub>	Input Continuous Wave Power	26 dBm	<u>2/</u>
P <sub>D</sub>	Power Dissipation	8.8 W	<u>2/</u> , <u>3/</u>
T <sub>channel</sub>	Channel Temperature	200 °C	<u>4/</u> , <u>5/</u>
	Mounting Temperature (30 Seconds)	320 °C	
	Storage Temperature	-65 to 150 °C	

- 1/ These ratings represent the maximum operable values for this device. Stresses beyond those listed under “Absolute Maximum Ratings” may cause permanent damage to the device and/or affect device lifetime. These are stress ratings only, and functional operation of the device at these conditions is not implied.
- 2/ Junction operating temperature will directly affect the device median lifetime. For maximum life, it is recommended that junction temperatures be maintained at the lowest possible levels.

**TABLE II**  
**DC PROBE TEST**  
 (T<sub>A</sub> = 25 °C, Nominal)

SYMBOL	PARAMETER	MINIMUM	MAXIMUM	UNIT
I <sub>dss, Q1</sub>	Saturated Drain Current	60	282	mA
G <sub>m, Q1</sub>	Transconductance	132	318	mS
V <sub>p, Q1,2, 3-6, 7-10</sub>	Pinch-off Voltage	-1.5	-0.5	V
V <sub>BVGD, Q1-10</sub>	Breakdown Voltage Gate-Drain	-30	-13	V
V <sub>BVGS, Q1,2,3-6,7-10</sub>	Breakdown Voltage Gate-Source	-30	-13	V

Note: Q1 & Q2 are 600 um FETs. Q3-6 & Q7-10 are 2400 um FETs. Q1-10 is a 6000 um FET.

**TABLE III**  
**RF CHARACTERIZATION TABLE**  
 (T<sub>A</sub> = 25 °C, Nominal)  
 V<sub>d</sub> = 7 V, I<sub>d</sub> = 760 mA

SYMBOL	PARAMETER	TEST CONDITION	LIMITS			UNITS
			MINIMUM	TYPICAL	MAXIMUM	
Gain	Small Signal Gain	F = 17 – 18 GHz	--	22	--	dB
		F = 17.5, 18 GHz	17	--	--	
		F = 20, 22, 24 GHz	18	23	--	
		F = 26.5 GHz	17	--	--	
		F = 27 GHz	--	20	--	
IRL	Input Return Loss	F = 17 – 27 GHz	--	20	--	dB
		F = 17.5, 18, 20, 22, 24 GHz	--	--	12	
		F = 26.5 GHz	--	--	10	
ORL	Output Return Loss	F = 17 – 27 GHz	--	15	--	dB
		F = 17.5, 18, 20, 22, 24 GHz	--	--	12	
		F = 26.5 GHz	--	--	10	
P <sub>1dB</sub>	Output Power @ 1dB Gain Compression	F = 17 – 27 GHz	--	30	--	dBm
		F = 18, 26.5 GHz	27	--	--	
OTOI *	Output Third Order Intercept	F = 17 – 27 GHz F = 18, 26 GHz	-- 34.5	37 --	-- --	dBm

\* Pin/tone = -7 dBm, Separation = 0.010 GHz

**TABLE IV**  
**THERMAL INFORMATION**

Parameter	Test Conditions	Tchannel (°C)	$\theta_{JC}$ (°C/W)	Tm (HRS)
$\theta_{JC}$ Thermal Resistance (channel to backside of carrier)	Vd = 7 V Id = 760 mA Pdiss = 5.3 W	150	15.1	1 E+6

Note: Assumes eutectic attach using 1.5 mil 80/20 AuSn mounted to a 20 mil CuMo Carrier at 70 °C baseplate temperature. Worst case condition with no RF applied, 100% of DC power is dissipated.

**Median Lifetime (Tm) vs. Channel Temperature**

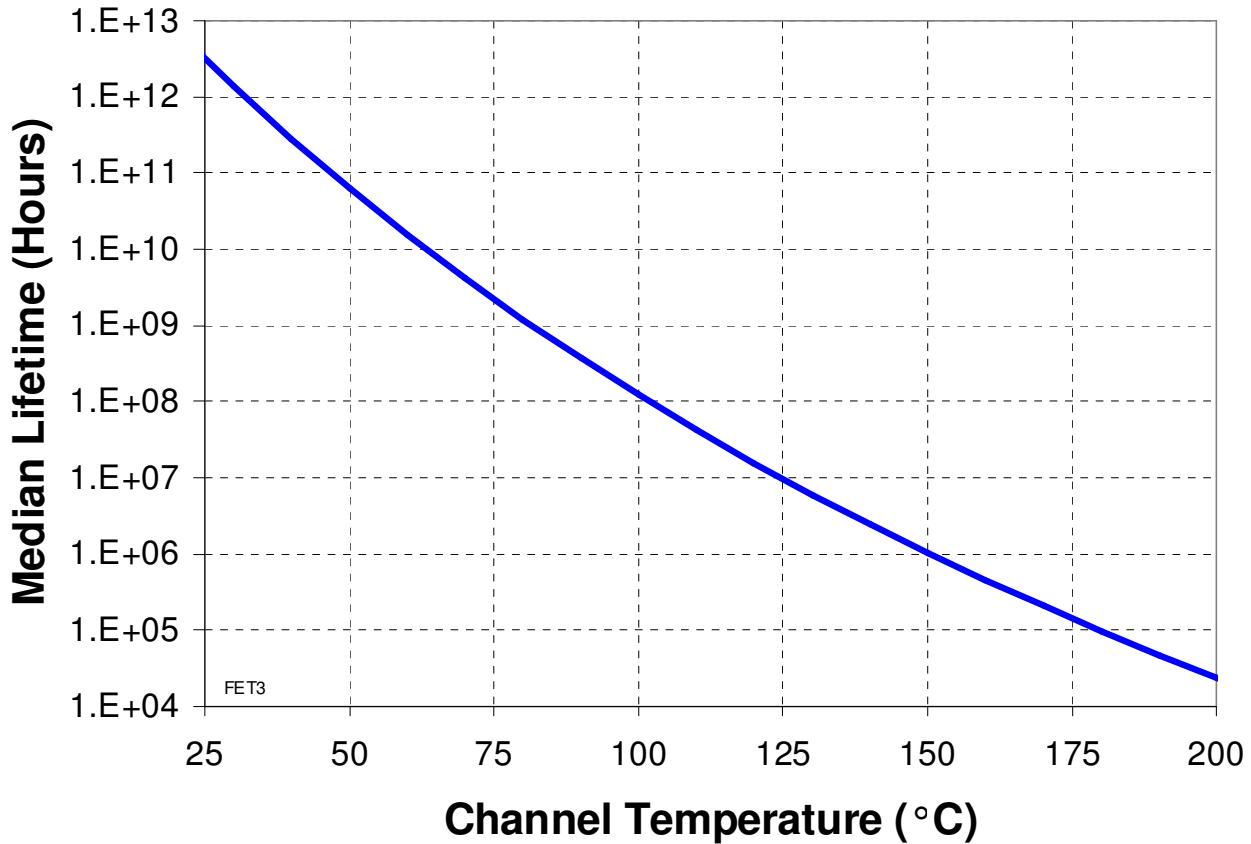

**Measured Fixtured Data**  
 Bias Conditions:  $V_d = 7\text{ V}$ ,  $I_d = 760\text{ mA}$

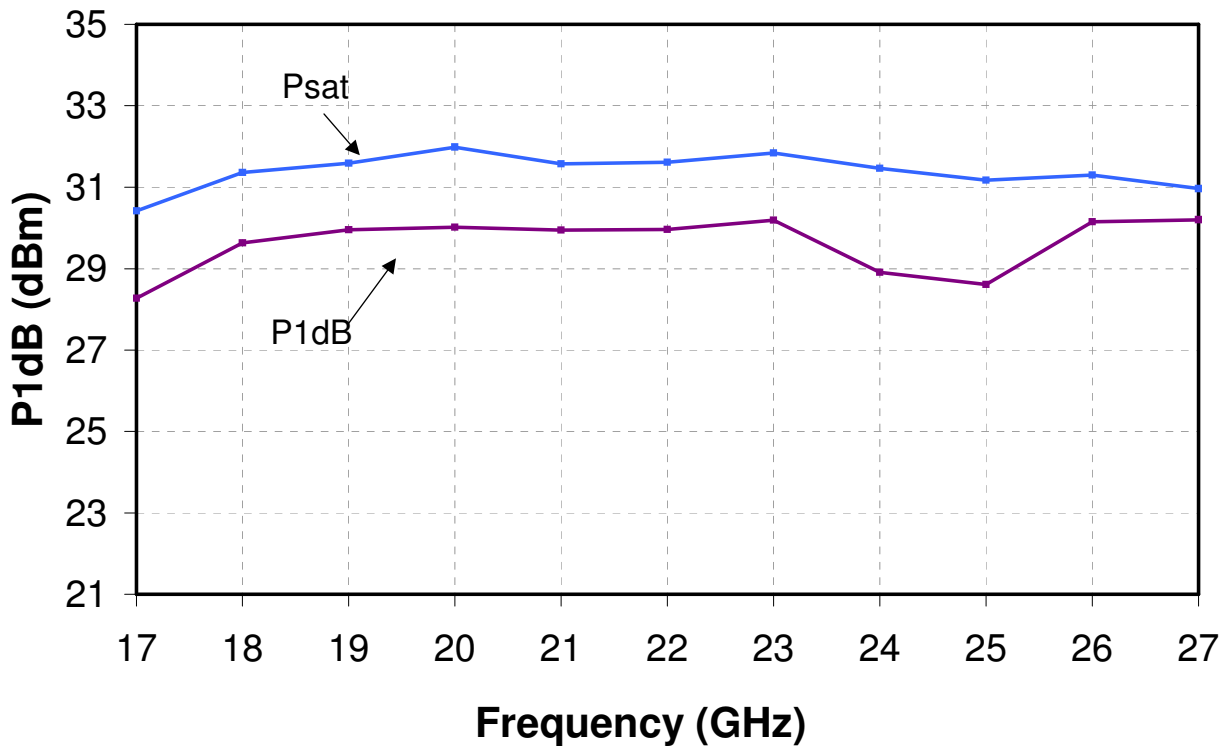
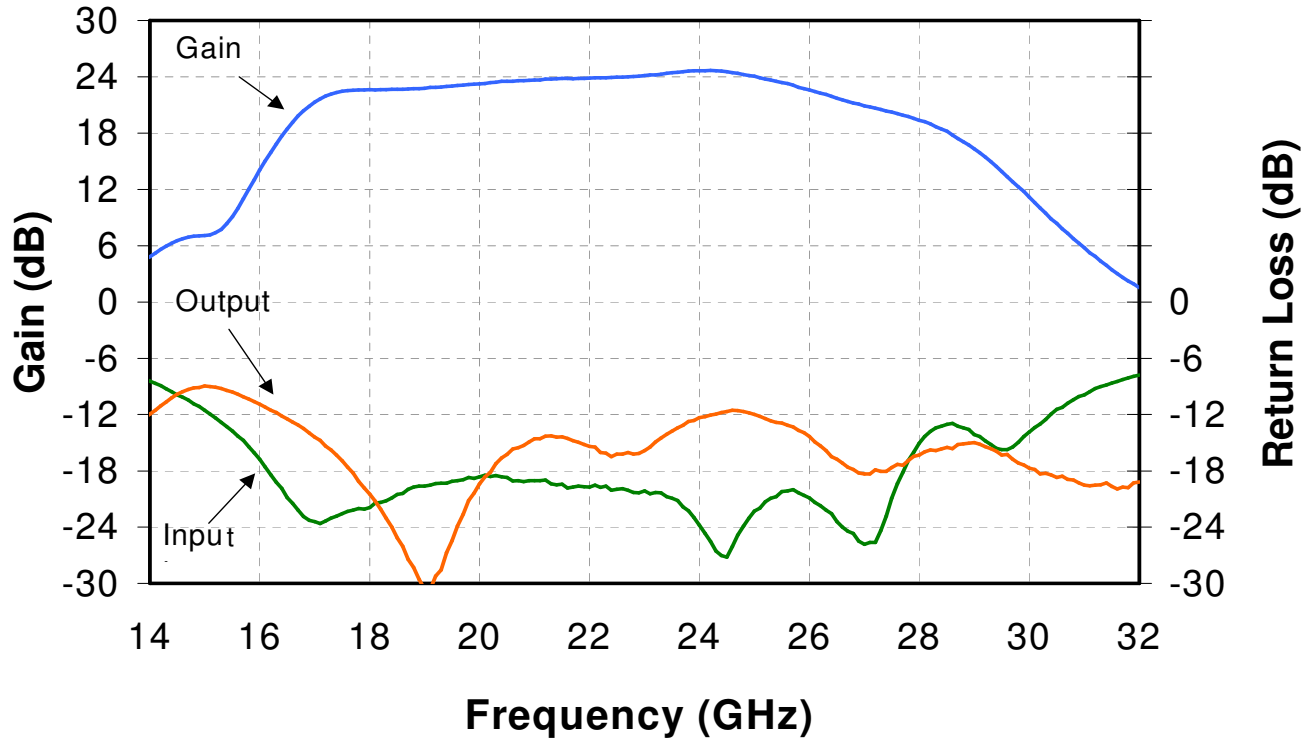

**Measured Fixtured Data**  
 Bias Conditions:  $V_d = 7\text{ V}$ ,  $I_d = 760\text{ mA}$

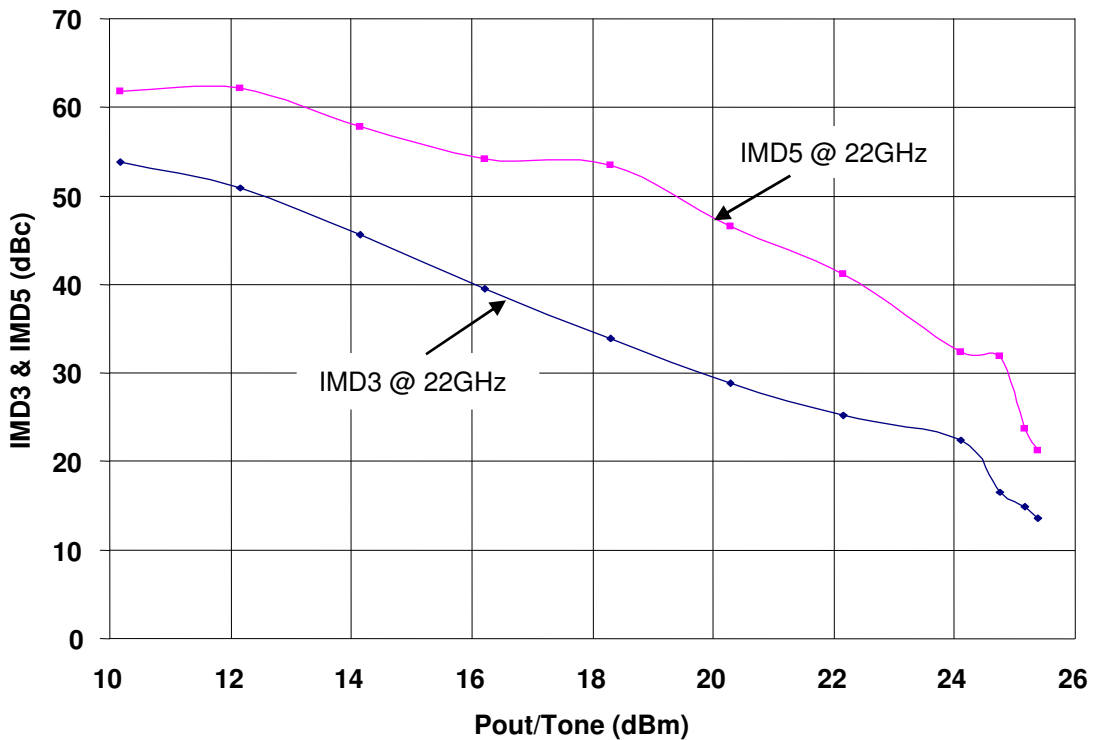
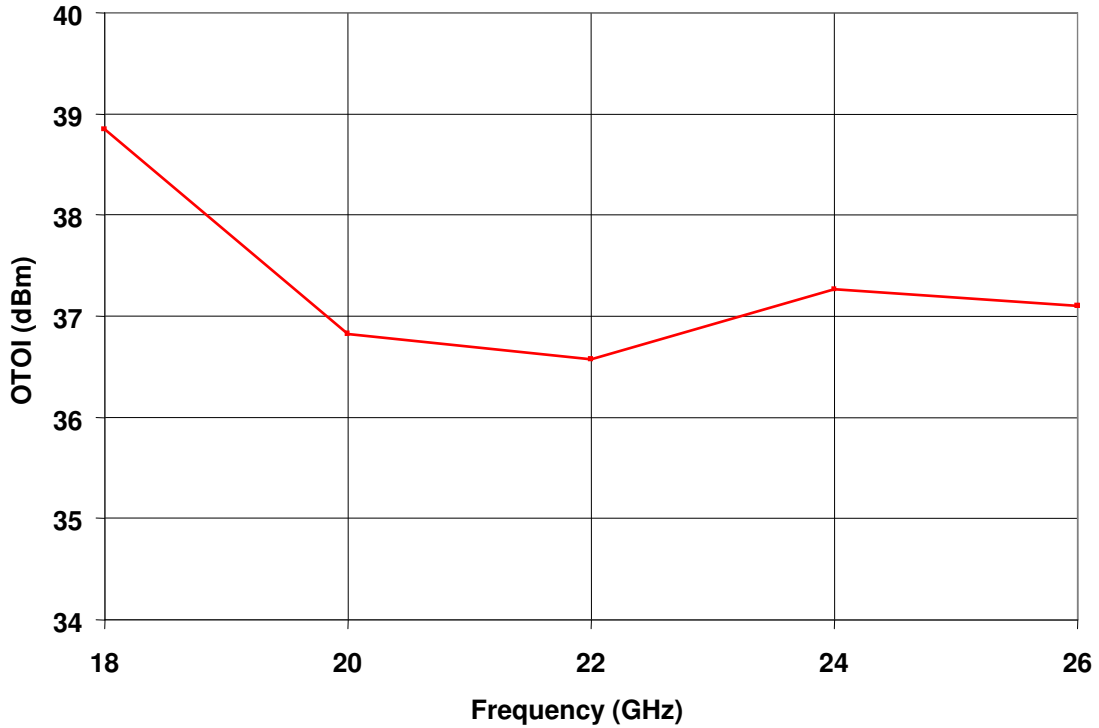

**Measured Fixtured Data**  
 Bias Conditions:  $V_d = 7\text{ V}$ ,  $I_d = 760\text{ mA}$

At Frequency: 18 GHz

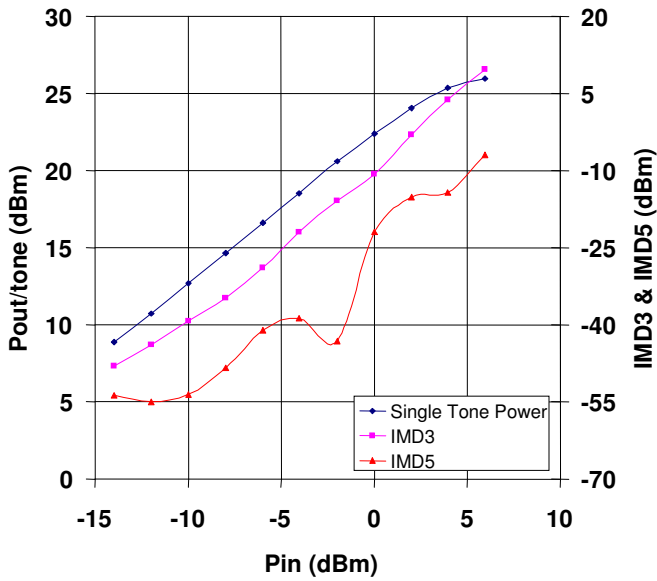

At Frequency: 20 GHz

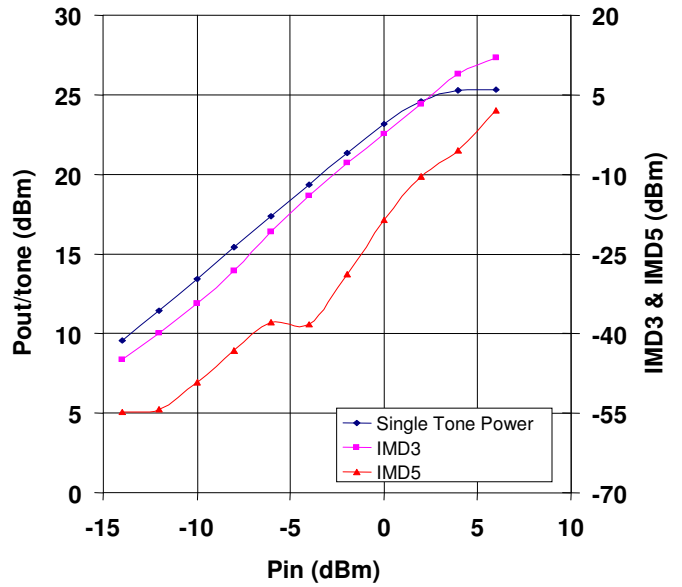

At Frequency: 24 GHz

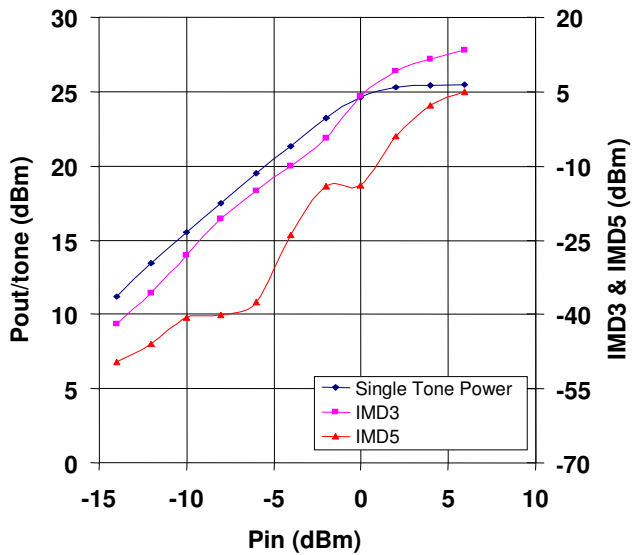

At Frequency: 26 GHz

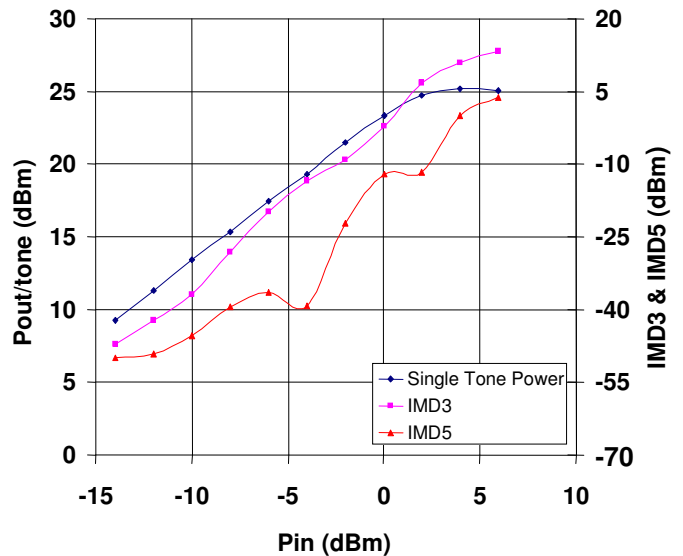

**Recommended Assembly Diagram**

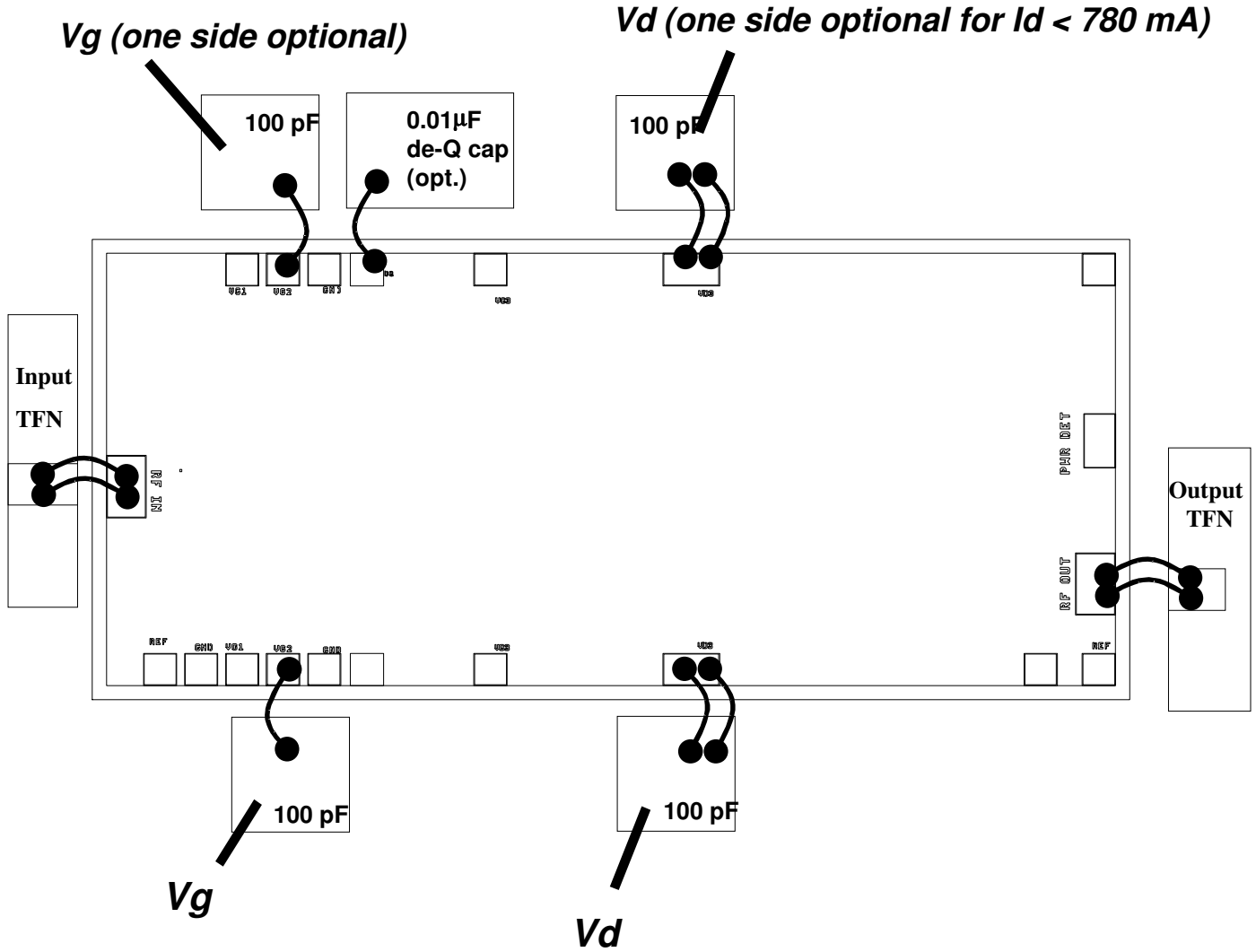

**Notes:**

1. Connection to power det, ref diode not shown.
2. 0.1μF cap on gate, drain lines not shown but required.
3. For high power operation, gate voltage is recommended from both sides.
4. Drain voltage is required from both sides for  $I_d > 780$  mA.

*GaAs MMIC devices are susceptible to damage from Electrostatic Discharge. Proper precautions should be observed during handling, assembly and test.*



**TGA4502 built-in power detector**

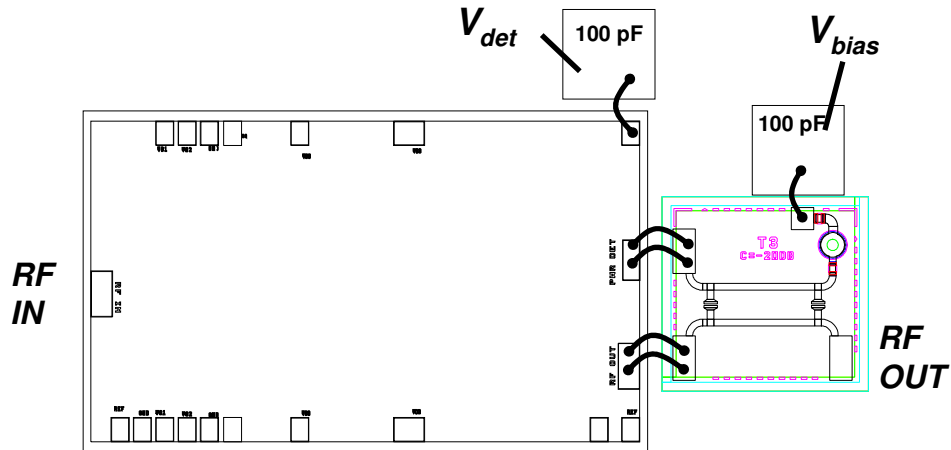

**TGA4502 with external test coupler  
(amplifier bias connections not shown)**

**On-chip diode functions as envelope detector  
External coupler and DC bias required**

TGA4502 measured detector voltage offset vs output power  
with 20dB coupler:  $V_b=0.8V$ ,  $f = 20GHz$ , Coupler loss is  
uncalibrated, 10KΩ load

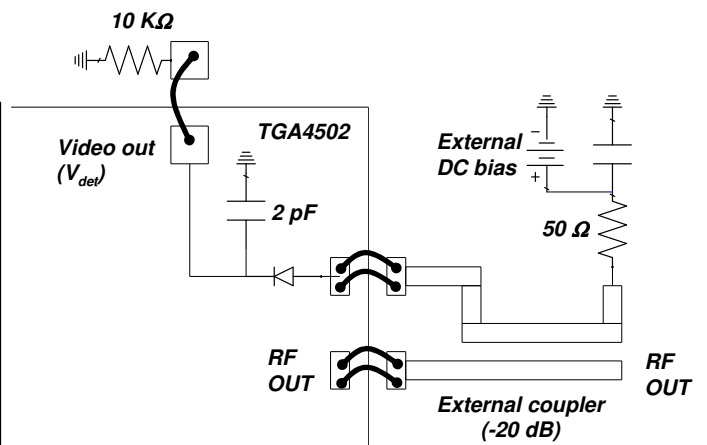
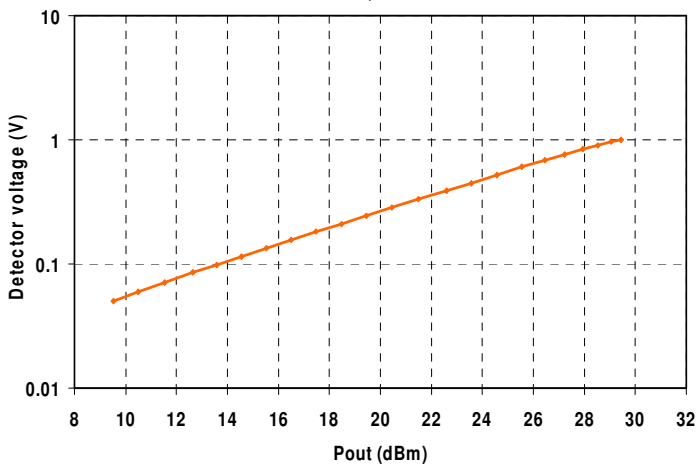

**Mechanical Drawing**

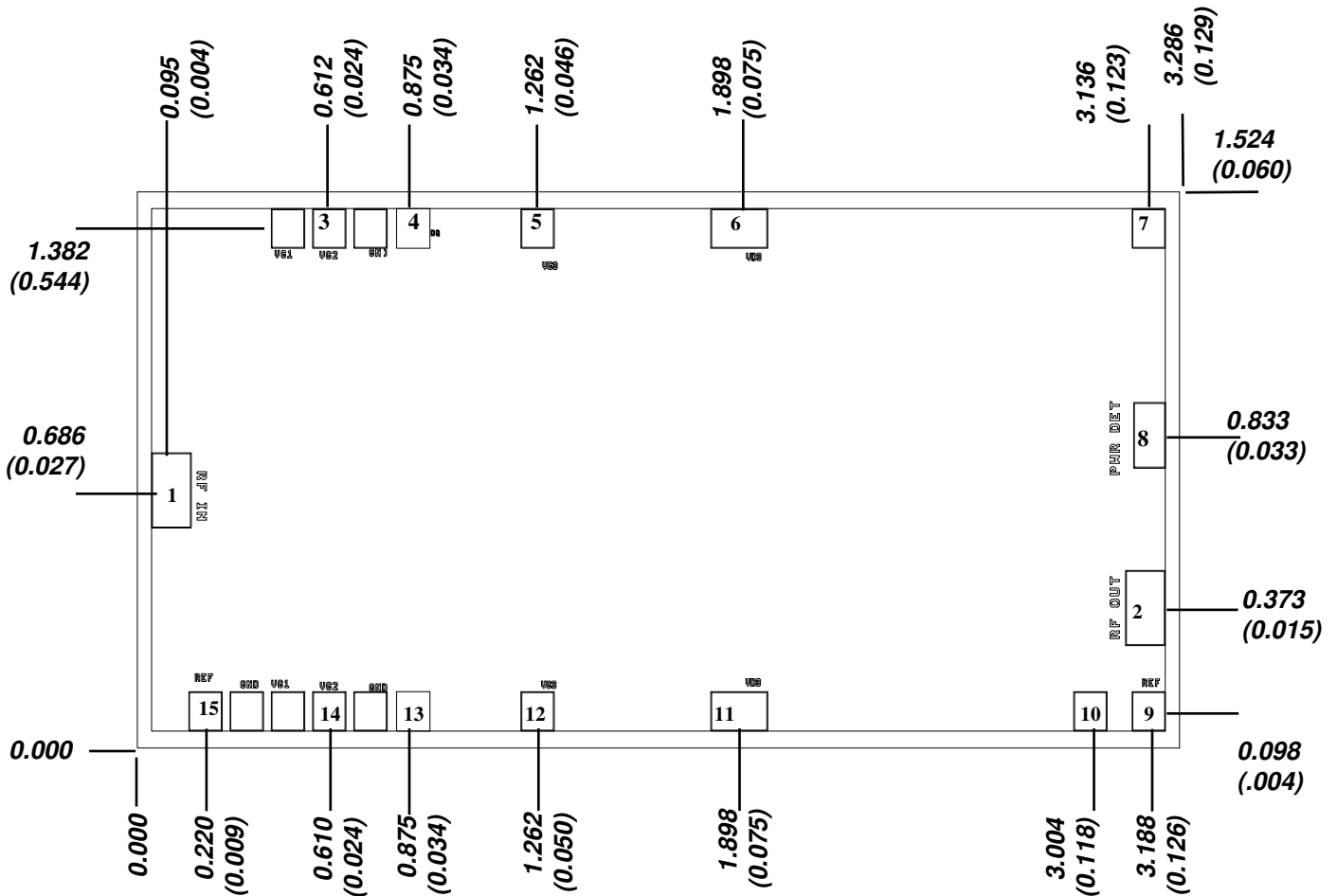

Units: Millimeters (inches)  
 Thickness: 0.100 (0.004) (reference only)  
 Chip edge to bond pad dimensions are shown to center of bond pad  
 Chip size tolerance +/- 0.051 (0.002)  
 GND IS BACKSIDE OF MMIC

Bond pad #1	(RF Input)	0.200 x 0.100 (0.008 x 0.004)	Bond pad #9	REF2	0.100 x 0.100 (0.004 x 0.004)
Bond pad #2	(RF Output)	0.200 x 0.100 (0.008 x 0.004)	Bond pad #10	REF1	0.100 x 0.100 (0.004 x 0.004)
Bond pad #3	VG2	0.100 x 0.100 (0.004 x 0.004)	Bond pad #11	VD3	0.180 x 0.100 (0.007 x 0.004)
Bond pad #4	DQ	0.100 x 0.100 (0.004 x 0.004)	Bond pad #12	VG3	0.100 x 0.100 (0.004 x 0.004)
Bond pad #5	VG3	0.100 x 0.100 (0.004 x 0.004)	Bond pad #13	DQ	0.100 x 0.100 (0.004 x 0.004)
Bond pad #6	VD3	0.180 x 0.100 (0.007 x 0.004)	Bond pad #14	VG2	0.100 x 0.100 (0.004 x 0.004)
Bond pad #7	DET OUT	0.100 x 0.100 (0.004 x 0.004)	Bond pad #15	REF3	0.100 x 0.100 (0.004 x 0.004)
Bond pad #8	PWR DET	0.175 x 0.100 (0.007 x 0.004)			

**GaAs MMIC devices are susceptible to damage from Electrostatic Discharge. Proper precautions should be observed during handling, assembly and test.**

### Assembly Process Notes

Reflow process assembly notes:

- Use AuSn (80/20) solder with limited exposure to temperatures at or above 300 °C (for 30 sec max).
- An alloy station or conveyor furnace with reducing atmosphere should be used.
- No fluxes should be utilized.
- Coefficient of thermal expansion matching is critical for long-term reliability.
- Devices must be stored in a dry nitrogen atmosphere.

Component placement and adhesive attachment assembly notes:

- Vacuum pencils and/or vacuum collets are the preferred method of pick up.
- Air bridges must be avoided during placement.
- The force impact is critical during auto placement.
- Organic attachment can be used in low-power applications.
- Curing should be done in a convection oven; proper exhaust is a safety concern.
- Microwave or radiant curing should not be used because of differential heating.
- Coefficient of thermal expansion matching is critical.

Interconnect process assembly notes:

- Thermosonic ball bonding is the preferred interconnect technique.
- Force, time, and ultrasonics are critical parameters.
- Aluminum wire should not be used.
- Discrete FET devices with small pad sizes should be bonded with 0.0007-inch wire.
- Maximum stage temperature is 200 °C.

### Ordering Information

Part	Package Style
TGA4502	GaAs MMIC Die

***GaAs MMIC devices are susceptible to damage from Electrostatic Discharge. Proper precautions should be observed during handling, assembly and test.***