

# Ka Band Low Noise Amplifier

# TGA4507

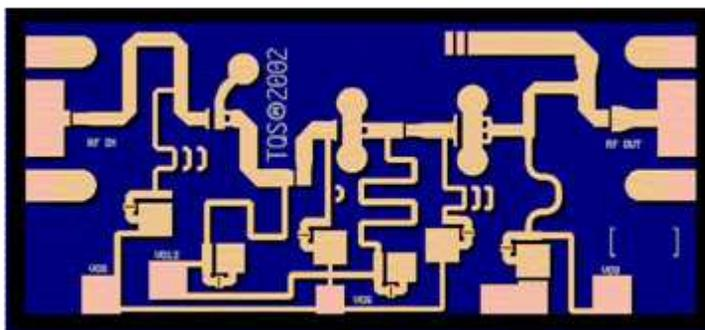

## Key Features

- Typical Frequency Range: 28 - 36 GHz
- 2.3 dB Nominal Noise Figure
- 22 dB Nominal Gain
- 12 dBm Nominal P1dB
- Bias 3.0 V, 60 mA
- 0.15 um 3MI pHEMT Technology
- Chip Dimensions 1.86 x 0.85 x 0.1 mm  
(0.073 x 0.033 x 0.004 in)

## Primary Applications

- Point-to-Point Radio
- Point-to-MultiPoint Radio
- Ka Band VSAT

## Preliminary Measured Data

Bias Conditions:  $V_d = 3.0\text{ V}$ ,  $I_d = 60\text{ mA}$

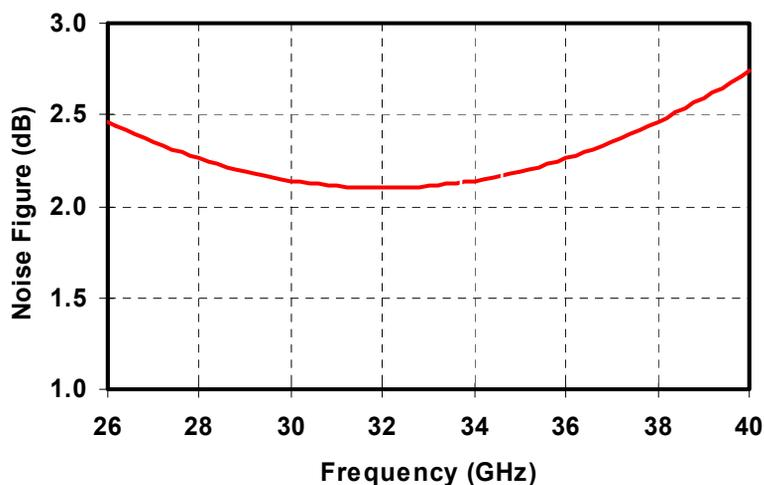
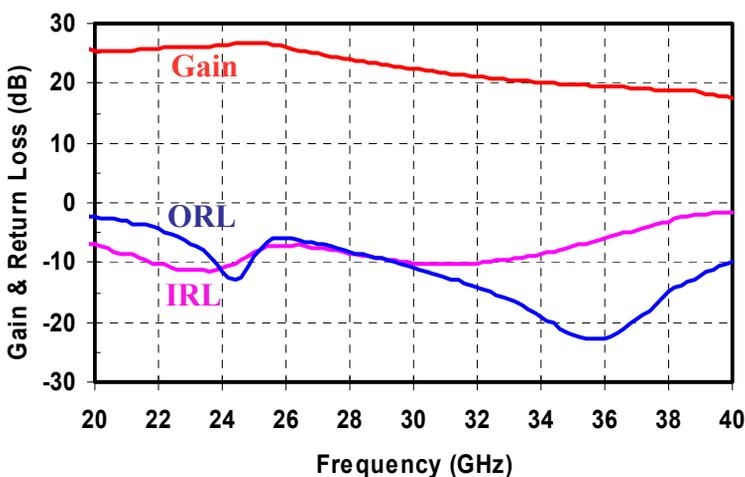

Note: Datasheet is subject to change without notice.

**TABLE I  
MAXIMUM RATINGS <sup>1/</sup>**

SYMBOL	PARAMETER	VALUE	NOTES
V <sub>d</sub>	Drain Voltage	5 V	<u>2/</u>
V <sub>g</sub>	Gate Voltage Range	-1 TO +0.5 V	
I <sub>d</sub>	Drain Current	280 mA	<u>2/ 3/</u>
I <sub>g</sub>	Gate Current	6 mA	<u>3/</u>
P <sub>IN</sub>	Input Continuous Wave Power	12 dBm	
P <sub>D</sub>	Power Dissipation	0.35 W	<u>2/ 4/</u>
T <sub>CH</sub>	Operating Channel Temperature	150 °C	<u>5/ 6/</u>
T <sub>M</sub>	Mounting Temperature (30 Seconds)	320 °C	
T <sub>STG</sub>	Storage Temperature	-65 to 150 °C	

- <sup>1/</sup> These ratings represent the maximum operable values for this device.
- <sup>2/</sup> Combinations of supply voltage, supply current, input power, and output power shall not exceed P<sub>D</sub>.
- <sup>3/</sup> Total current for the entire MMIC.
- <sup>4/</sup> When operated at this bias condition with a base plate temperature of TBD, the median life is reduced from TBD to TBD hrs.
- <sup>5/</sup> Junction operating temperature will directly affect the device median time to failure (MTTF). For maximum life, it is recommended that junction temperatures be maintained at the lowest possible levels.
- <sup>6/</sup> These ratings apply to each individual FET.

**THERMAL INFORMATION**

Parameter	Test Condition	T <sub>CH</sub> (°C)	R <sub>θJC</sub> (°C/W)	MTTF (HRS)
R <sub>θJC</sub> Thermal Resistance (channel to backside of carrier)	V <sub>d</sub> = 3 V, I <sub>D</sub> = 60 mA	94	132	>1E6

Note: Assumes eutectic attach using 1.5 mil 80/20 AuSn mounted to a 20 mil CuMo Carrier at 70°C baseplate temperature. Worst case condition with no RF applied, 100% of DC power is dissipated.

**TABLE II**  
**DC PROBE TESTS**  
(Ta = 25 °C, Nominal)

SYMBOL	PARAMETER	MIN.	TYP.	MAX.	UNITS
$V_{BVD3}$	Breakdown Voltage Gate-Source			-5	V
$V_{P1,2,3}$	Pinch-off Voltage		-0.4		V

Q1 is 100 um FET, Q2 is 200 um FET, Q3 is 300 um FET.

**TABLE III**  
**ELECTRICAL CHARACTERISTICS**  
(Ta = 25 °C Nominal)

PARAMETER	TYPICAL	UNITS
Drain Voltage, Vd	3.0	V
Drain Current, Id	60	mA
Gate Voltage, Vg	-0.5 to 0	V
Small Signal Gain, S21	22	dB
Input Return Loss, S11	8	dB
Output Return Loss, S22	8	dB
Noise Figure, NF	2.3	dB
Output Power @ 1 dB Compression Gain, P1dB	12	dBm

### Preliminary Measured Data

Bias Conditions:  $V_d = 3.0\text{ V}$ ,  $I_d = 60\text{ mA}$

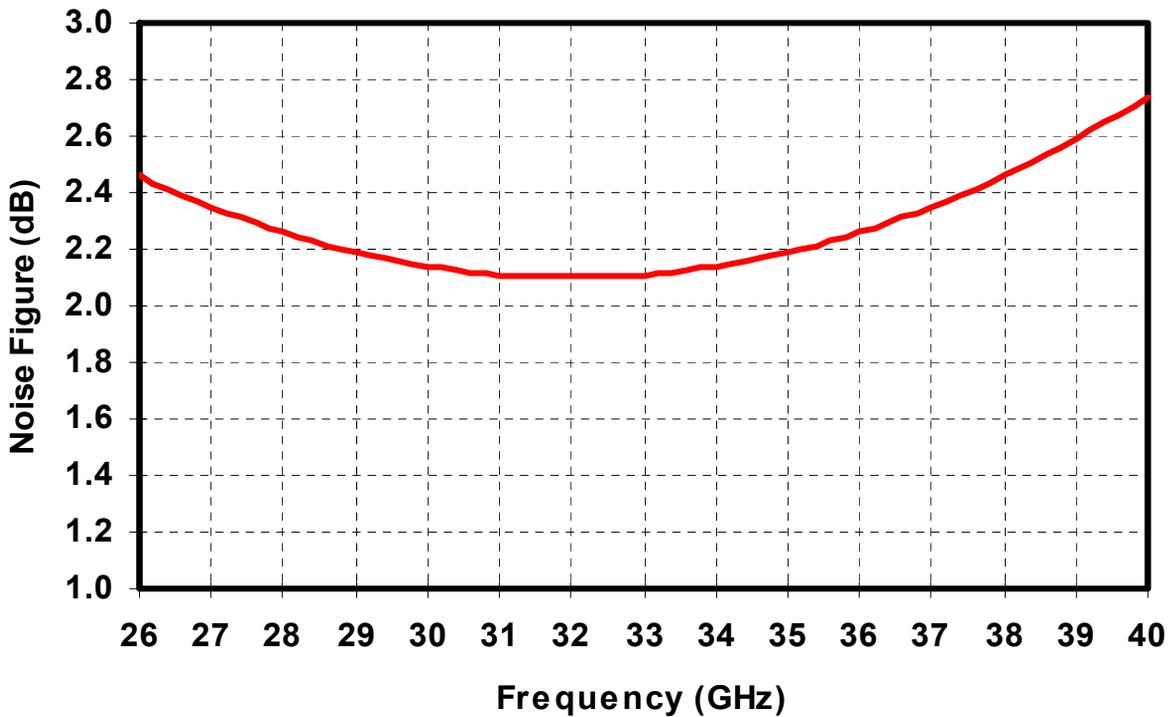
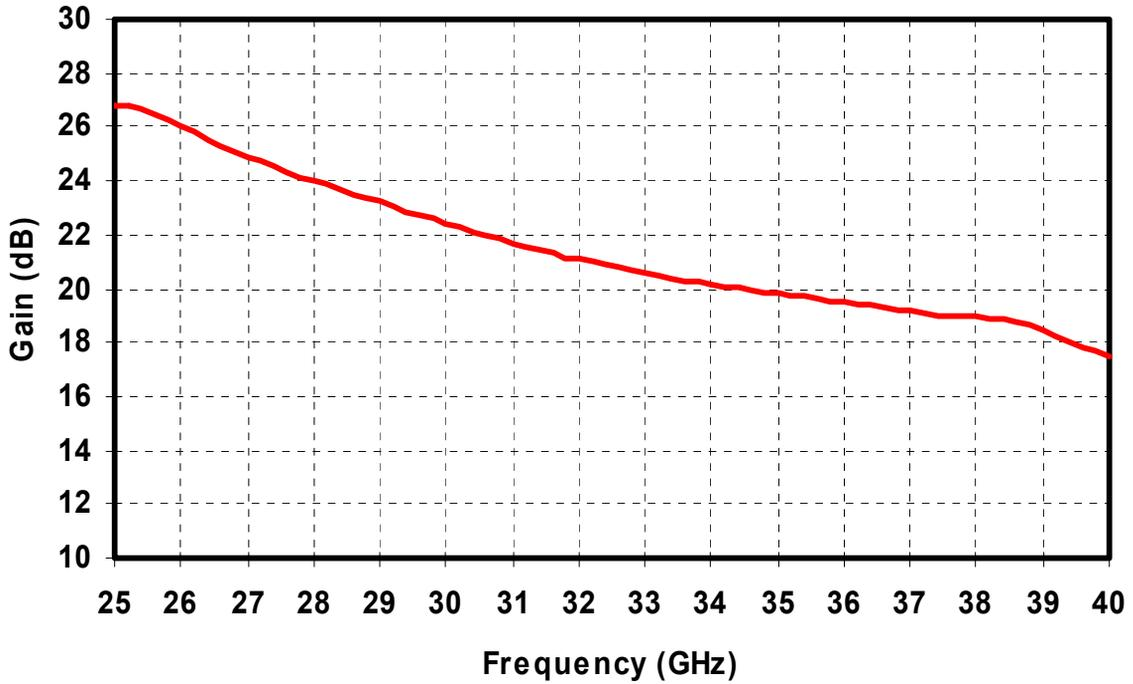

### Preliminary Measured Data

Bias Conditions:  $V_d = 3.0\text{ V}$ ,  $I_d = 60\text{ mA}$

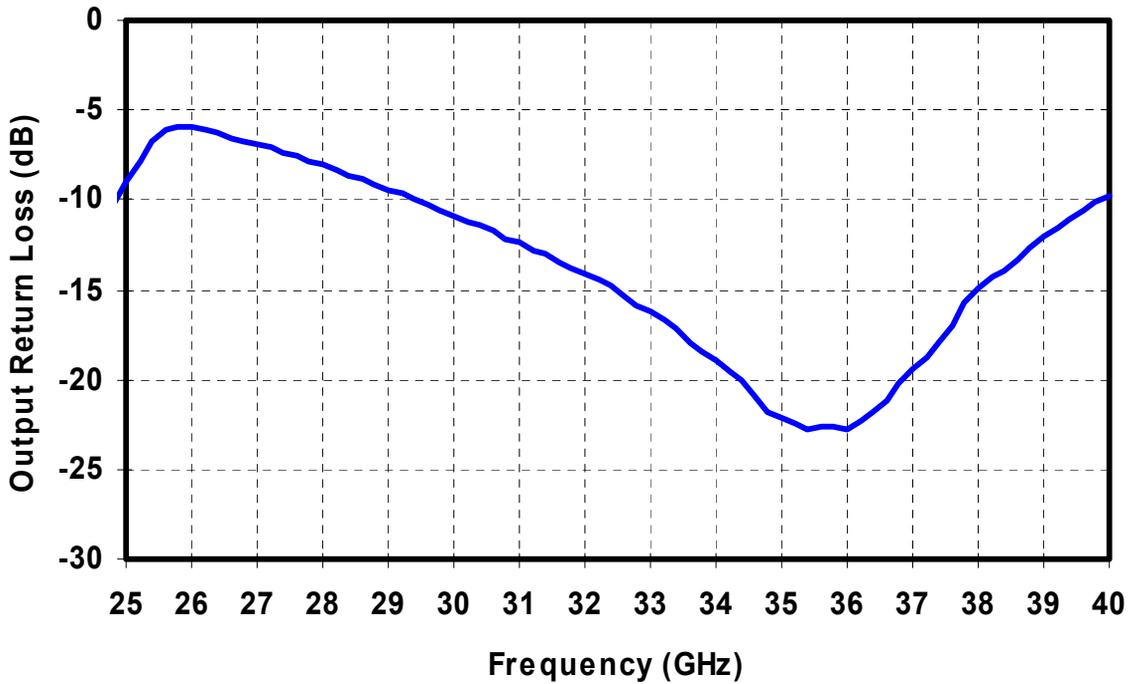
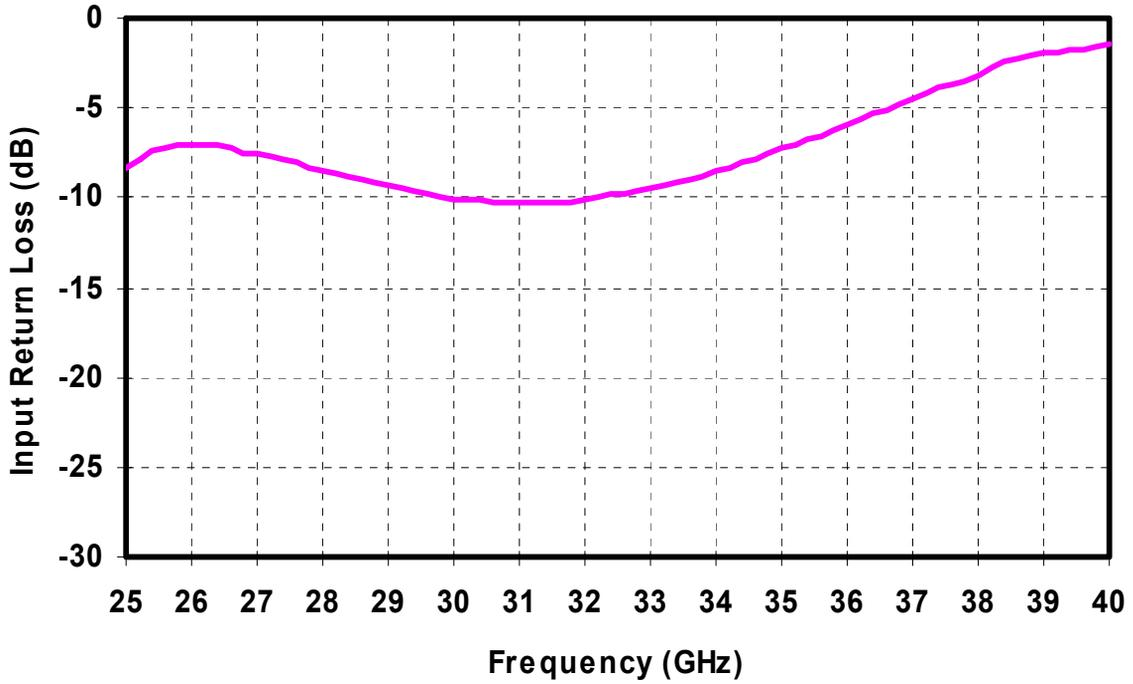

**Preliminary Measured Data**

Bias Conditions:  $V_d = 3.0\text{ V}$ ,  $I_d = 60\text{ mA}$ , Freq @ 30 GHz

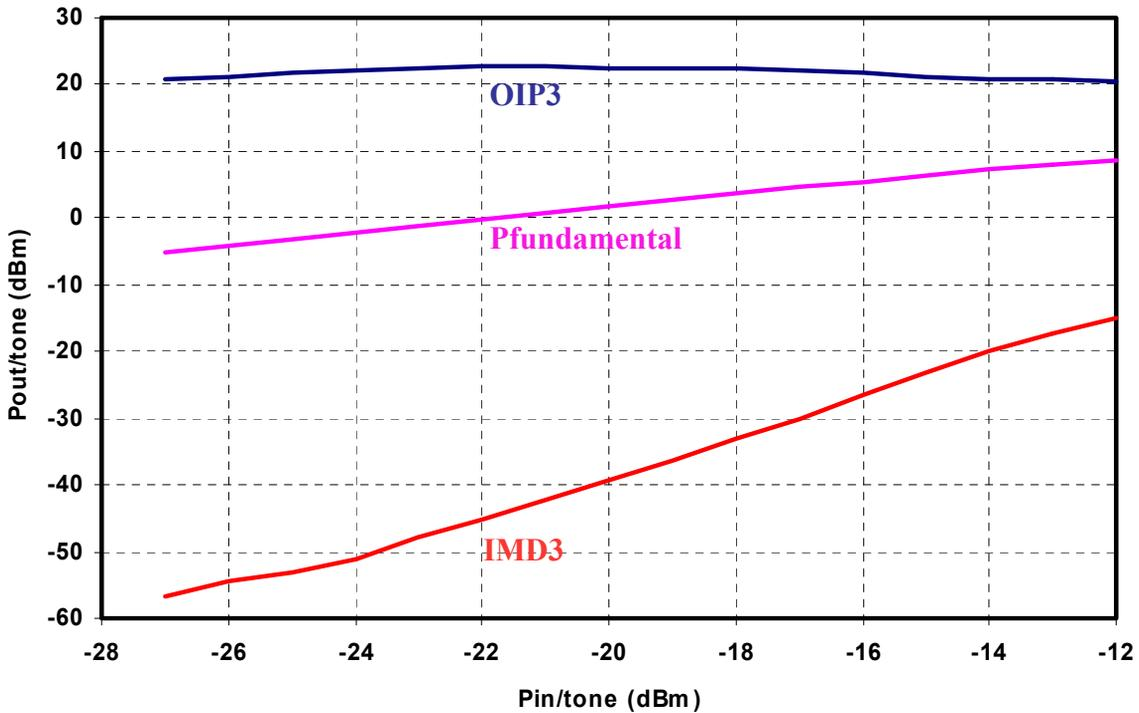
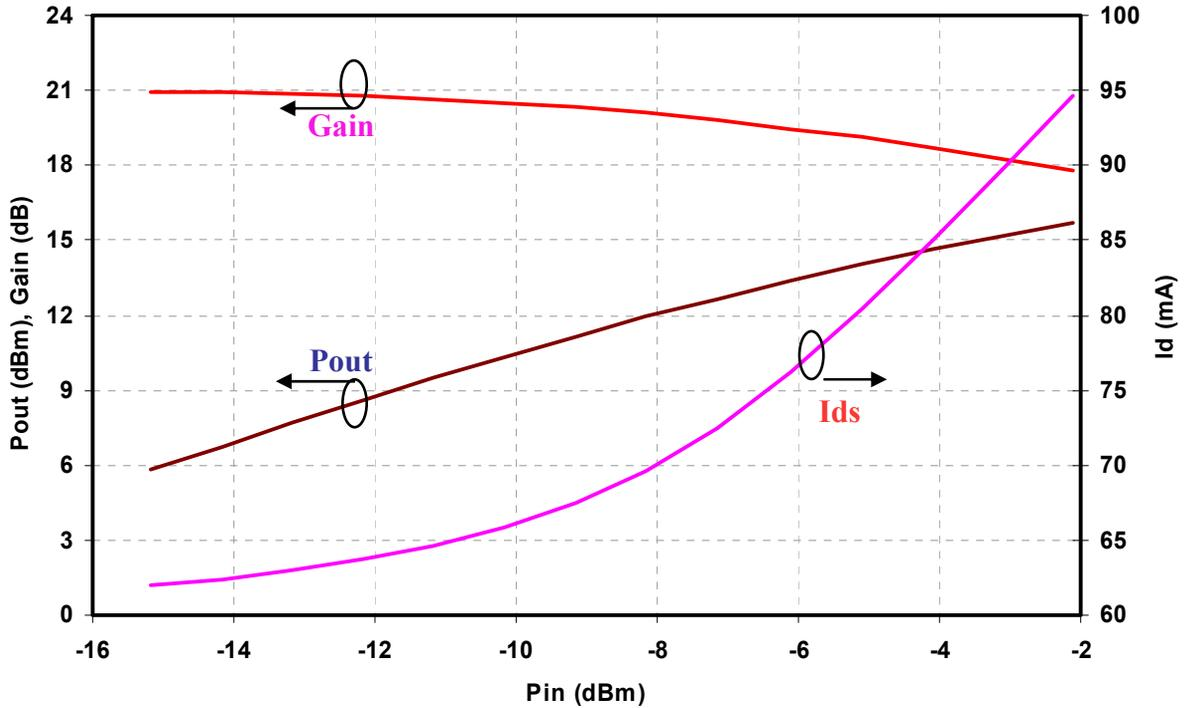



## Chip Assembly Diagram

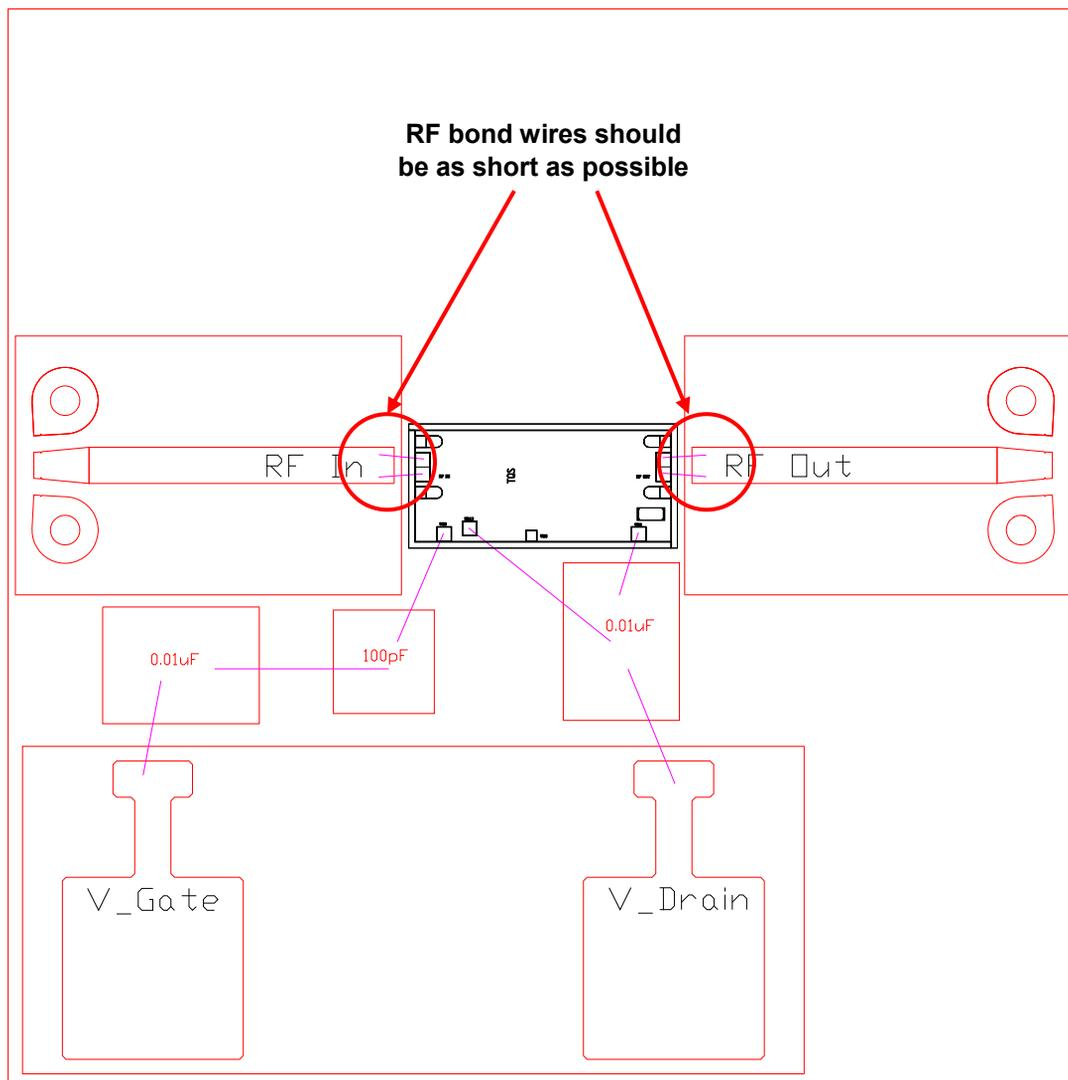

**GaAs MMIC devices are susceptible to damage from Electrostatic Discharge. Proper precautions should be observed during handling, assembly and test.**

## **Assembly Process Notes**

Reflow process assembly notes:

- Use AuSn (80/20) solder with limited exposure to temperatures at or above 300°C (30 seconds max).
- An alloy station or conveyor furnace with reducing atmosphere should be used.
- No fluxes should be utilized.
- Coefficient of thermal expansion matching is critical for long-term reliability.
- Devices must be stored in a dry nitrogen atmosphere.

Component placement and adhesive attachment assembly notes:

- Vacuum pencils and/or vacuum collets are the preferred method of pick up.
- Air bridges must be avoided during placement.
- The force impact is critical during auto placement.
- Organic attachment can be used in low-power applications.
- Curing should be done in a convection oven; proper exhaust is a safety concern.
- Microwave or radiant curing should not be used because of differential heating.
- Coefficient of thermal expansion matching is critical.

Interconnect process assembly notes:

- Thermosonic ball bonding is the preferred interconnect technique.
- Force, time, and ultrasonics are critical parameters.
- Aluminum wire should not be used.
- Maximum stage temperature is 200°C.

***GaAs MMIC devices are susceptible to damage from Electrostatic Discharge. Proper precautions should be observed during handling, assembly and test.***