

10.7Gb/s Modulator Driver Amplifier

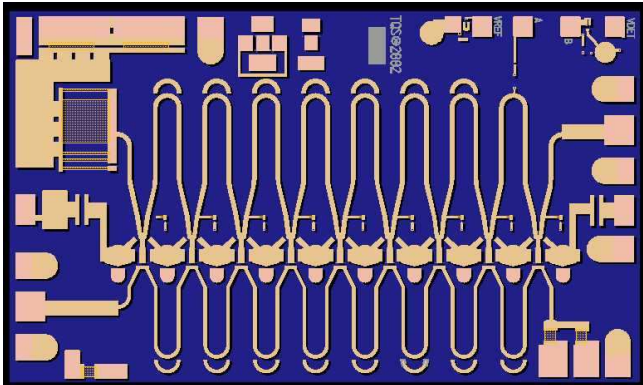

Key Features and Performance

- Single-ended Input / Output
- Small Signal Gain 19dB
- Small Signal Bandwidth 10GHz
- Wide Drive Range (3V to 11V)
- 25ps Edge Rates (20/80)
- Power Dissipation 2.25Watts
- Die Size: 3.3 x 2 x 0.1 mm

Description

The TriQuint TGA4807 is part of a series of optical driver amplifiers suitable for a variety of driver applications.

The TGA4807 is a medium power wideband AGC amplifier MMIC die that typically provides 19dB small signal gain with 19dB AGC range. RF ports are DC coupled enabling the user to customize system corner frequencies.

The TGA4807 is an excellent choice for applications requiring high drive levels. The TGA4807 has demonstrated capability to amplify a 2V input signal to 11Vpp saturated.

The TGA4807 requires off-chip decoupling, a DC block and a bias tee. The TGA4807 is available in die form.

Lead-free and RoHS compliant

Primary Applications

- Mach-Zehnder Modulator Driver for Metro and Long Haul.

Measured Performance

TGA4807 Fixtured Data
 $V_d(R_{fout})=7V$, $I_d=250mA$, ($P_{dc}=1.75W$)
 $V_{out}=11V_{pp}$, $V_{in} = 2V_{pp}$
 Scale: 2V/div, 15ps/div

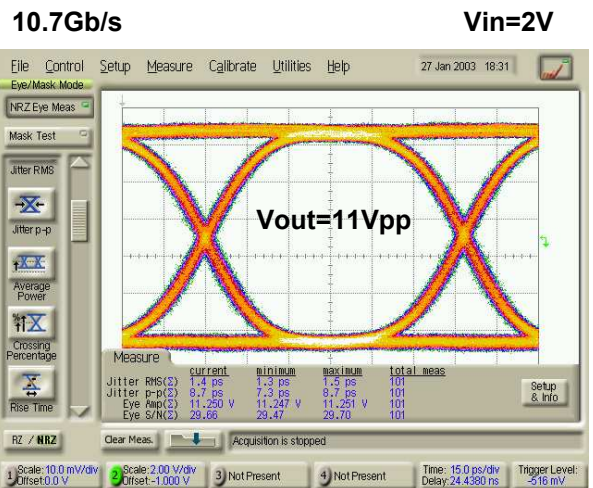

MAXIMUM RATINGS

SYMBOL	PARAMETER <u>6/</u>	VALUE	NOTES
V _d	POSITIVE SUPPLY VOLTAGE Drain Voltage at RF output	7 V	
I _d	POSITIVE SUPPLY CURRENT Drain Current	285 mA	<u>1/</u>
P _d	POWER DISSIPATION	2.2 W	<u>2/</u>
V _g I _g	NEGATIVE GATE Voltage Gate Current	0 V to -3 V 5 mA	
V _{ctrl} I _{ctrl}	CONTROL GATE Voltage Gate Current	V _d /2 to -3 V 5 mA	<u>3/</u>
P _{IN}	RF INPUT Sinusoidal Continuous Wave Power	23 dBm	
T _{CH}	OPERATING CHANNEL TEMPERATURE	200 °C	<u>4/ 5/</u>
	MOUNTING TEMPERATURE (30 SECONDS)	320 °C	
T _{STG}	STORAGE TEMPERATURE	-65 to 150 °C	

Notes:

- 1/ Assure the combination of V_d and I_d does not exceed maximum power dissipation rating.
- 2/ When operated at this bias condition with a base plate temperature of 70 °C, the median life is 3.4E6 hours.
- 3/ Assure V_{ctrl} never exceeds V_d during bias on and off sequences, and normal operation.
- 4/ These ratings apply to each individual FET.
- 5/ Junction operating temperature will directly affect the device median time to failure (T_m). For maximum life, it is recommended that junction temperatures be maintained at the lowest possible levels.
- 6/ These ratings represent the maximum operable values for the device.

THERMAL INFORMATION

Parameter	Test Condition	P _{diss} (W)	T _{Base} (°C)	T _{CH} (°C)	θ _{JC} (°C/W)	T _m (HRS)
θ _{JC} Thermal Resistance (channel to backside of carrier)	VD(RFout)=7V Id=250mA	1.75	70	122	30	1.2E7

Notes:

1. Assumes worst case power dissipation condition where no RF is applied at the input (no power is dissipated in the load).
2. Thermal transfer is conducted thru the bottom of the TGA4807 into the mounting carrier. Design the mounting interface to assure adequate thermal transfer to the base plate.

Median Lifetime (Tm) vs. Channel Temperature

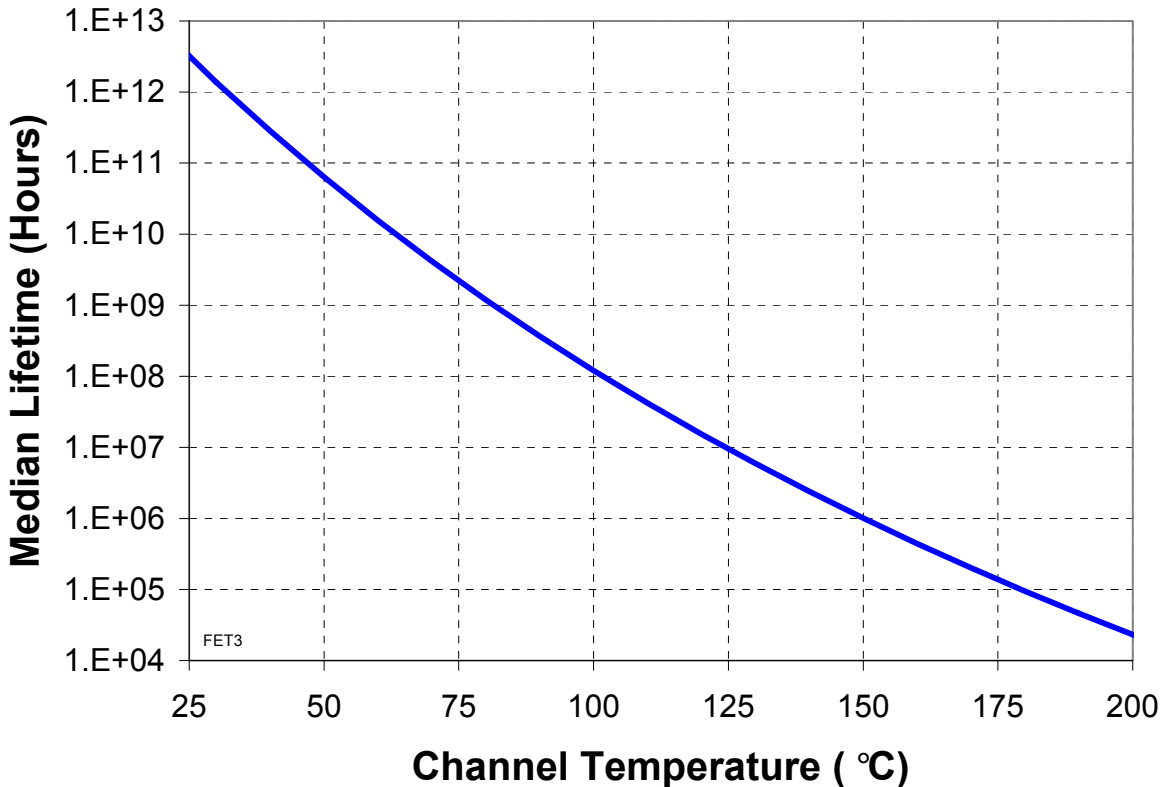

DC PROBE TEST
(TA = 25 °C, nominal)

NOTES	SYMBOL	LIMITS		UNITS
		MIN	MAX	
<u>1/</u> , <u>2/</u>	$ V_{BVGS} $	13		V
<u>1/</u> , <u>2/</u>	$ V_{BVGD} $	13		V

Notes:

1/ Verified at die level on-wafer probe.

2/ V_{BVGS} and V_{BVDS} are negative.

Definitions:

V_{BVGS} : Breakdown voltage, Gate to Source

V_{BVGD} : Breakdown voltage, Gate to Drain

RF SPECIFICATIONS (T_A = 25°C Nominal)

NOTE	TEST	MEASUREMENT CONDITIONS	VALUE			UNITS
			MIN	TYP	MAX	
	SMALL SIGNAL BW			10		GHz
<u>1/</u> , <u>2/</u>	SMALL-SIGNAL GAIN MAGNITUDE	2 GHz 4 GHz 6 GHz 10 GHz 14 GHz	18 17 16 15 12			dB
<u>1/</u> , <u>2/</u>	SMALL SIGNAL AGC RANGE	2, 4, 6, 10, and 14GHz		20		dB
<u>1/</u> , <u>2/</u>	INPUT RETURN LOSS MAGNITUDE	2, 4, 6, 10, and 14GHz		10		dB
<u>1/</u> , <u>2/</u>	OUTPUT RETURN LOSS MAGNITUDE	2, 4, 6, 10, and 14GHz		12		dB
<u>3/</u> , <u>4/</u>	SATURATED OUTPUT POWER	2, 4, 6, 10, and 14GHz	25			dBm
<u>3/</u> , <u>4/</u>	EYE AMPLITUDE	Vd(Rfout) = 7V Vd(Rfout) = 6V Vd(Rfout) = 5V Vd(Rfout) = 4V	11.0 10.0 9.0 8.0			Vpp
<u>3/</u> , <u>5/</u>	ADDITIVE JITTER			5		ps
<u>3/</u>	RISE TIME			25		ps

Notes:

1/ Verified at package level RF probe.

2/ Bias: V⁺ = 7 V, adjust Vg1 to achieve Id = 250 mA, Vctrl = +1 V

3/ Verified by design, TGA4807 assembled onto a demonstration board shown on page 9 then tested using the application circuit and bias procedure detailed on pages 7 and 8.

4/ Vin = 2 V, Data Rate = 12.5 Gb/s, Vctrl and Vg are adjusted for maximum output.

5/ Computed using RSS Method where Jpp_additive = SQRT(Jpp_out² - Jpp_in²)

Typical Small Signal S-Parameters

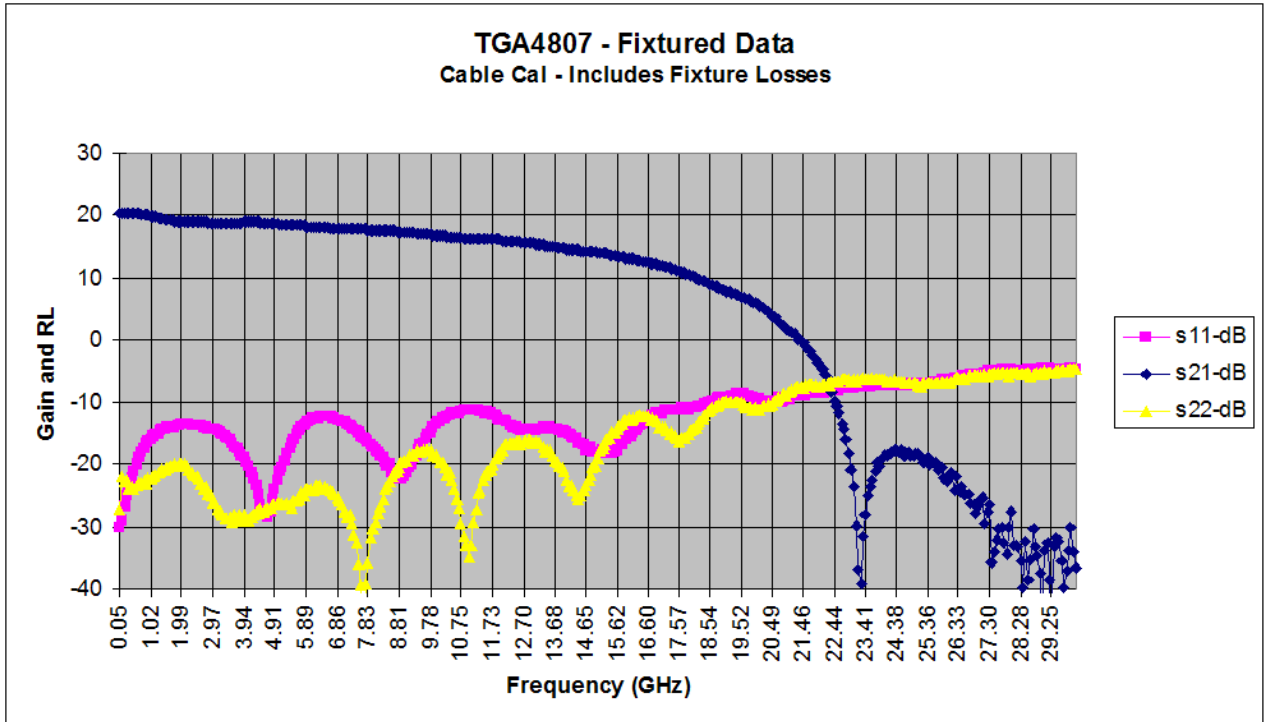

TGA4807 Application Circuit

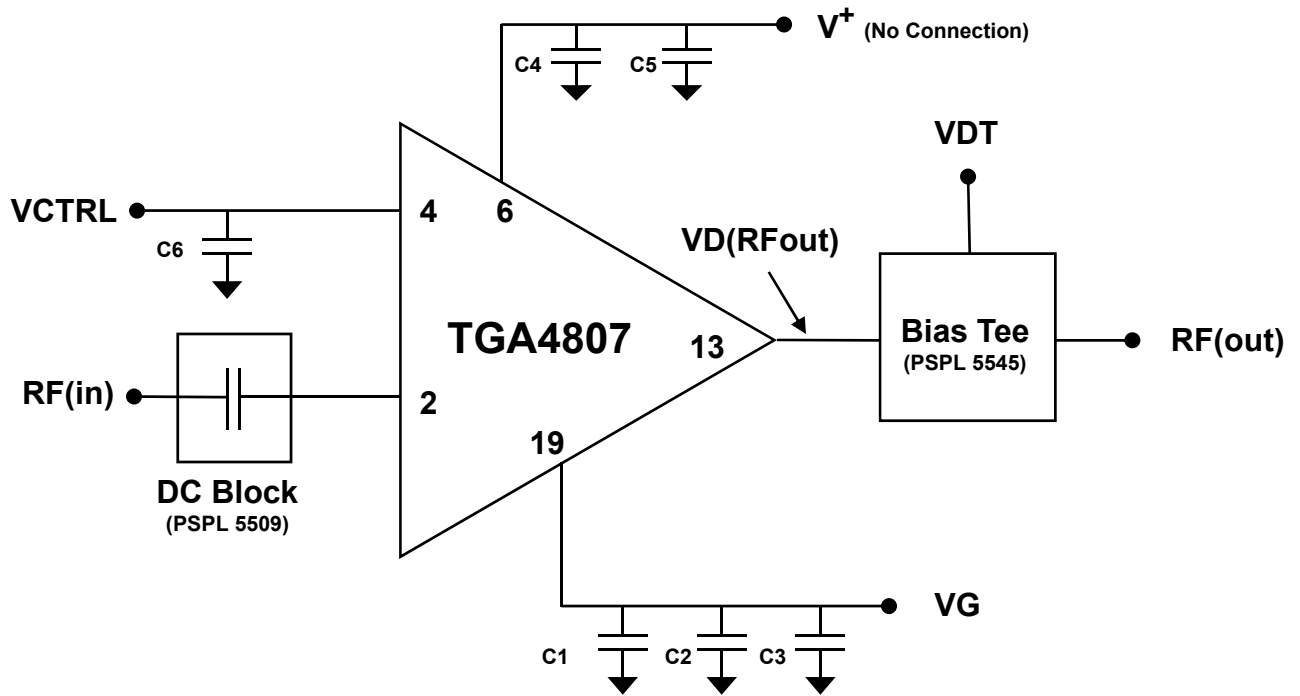

Notes:

Recommended Components are detailed on page 9.

Bias Procedure for 11V Output

Bias ON

1. Disable the RF source (PPG)
2. Set $V_{dT}=0V$ $V_{ctrl}=0V$ and $V_g=0V$
3. Set $V_g=-1.5V$
4. Increase V_{dT} to 8V observing I_d .
 - Assure $I_d=0mA$
5. Set $V_{ctrl}=+1.2V$
 - I_d should still be 0mA
6. Make V_g more positive until **$I_{dd}=250mA$** .
 - Typical value for **V_g is $-0.2V$**
7. Measure V^+ , adjust V_{dT} such that V^+ is 7V.
 - This will set $V_d(RF_{out})$ to approximately 7V.
 - I_{dd} will increase slightly
8. Adjust V_g such that $I_{dd}=250mA$.
9. Enable the RF source (PPG)
 - Set $V_{in}=2V$
10. Output Swing Adjust: Adjust V_{ctrl} slightly positive to increase output swing or adjust V_{ctrl} slightly negative to decrease the output swing.
 - Typical value for **V_{ctrl} is $+1.2V$** for $V_o=11V$.
11. Crossover Adjust: Adjust V_g slightly positive to push the crossover down or adjust V_g slightly negative to push the crossover up.
 - Typical value for **V_g is $-0.57V$** to center crossover with $V_o=11V$.

Bias OFF

1. Disable the output of the PPG
2. Set $V_{ctrl}=0V$
3. Set $V_{dT}=0V$
4. Set $V_g=0V$

Notes:

1. Assure V_{ctrl} never exceeds V_d during Bias ON and Bias OFF sequences and during normal operation.

Recommended Assembly Diagram

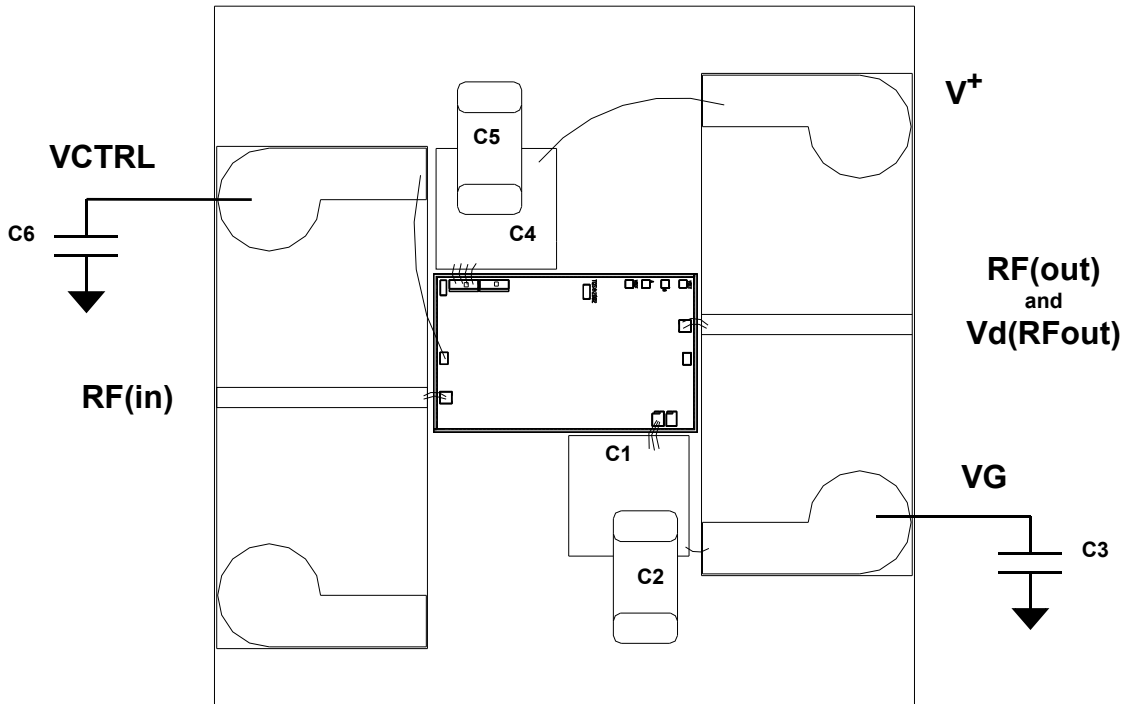

Recommended Components:

DESIGNATOR	DESCRIPTION	MANUFACTURER	PART NUMBER
C1, C4	1500pF Capacitor SLC	Presidio	SL5050X7R1522H5
C2, C5	0.1uF Capacitor MLC Ceramic	AVX	0603YC104KAT
C3	10uF Capacitor MLC Ceramic	AVX	0603YC102KAT
C6	0.01 uF Capacitor MLC	AVX	0603YC103KAT

GaAs MMIC devices are susceptible to damage from Electrostatic Discharge. Proper precautions should be observed during handling, assembly and test.

TGA4807 Detector Application Circuit

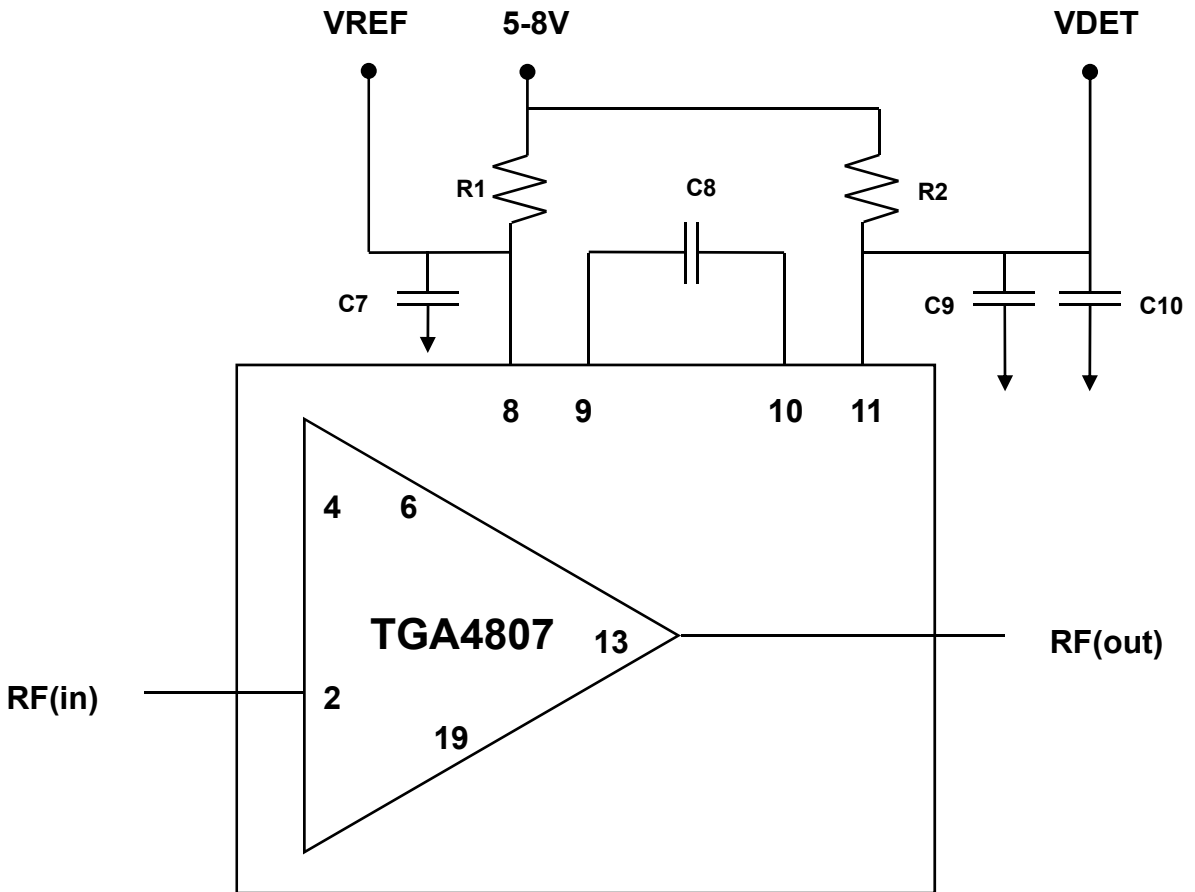

Recommended Components:

DESIGNATOR	DESCRIPTION	MANUFACTURER	PART NUMBER
R1, R2	40K ohm Resistor Chip Silicon	MSI	MSBC 2ST-40001F-E
C7, C8, C9	100pF Capacitor SLC Ceramic	AVX	GB015810KA6
C10	.01uF Capacitor MLC Ceramic	AVX	VL303X7R103M16VG5

Assembly Process Notes

Assembly Notes:

Reflow Attachment:

- Use AuSn (80/20) solder with limited exposure to temperatures at or above 300°C
- Use alloy station or conveyor furnace with reducing atmosphere
- No fluxes should be utilized
- Coefficient of thermal expansion matching is critical for long-term reliability
- Storage in dry nitrogen atmosphere

Adhesive Attachment:

- Organic attachment can be used in low-power applications
- Curing should be done in a convection oven; proper exhaust is a safety concern
- Microwave or radiant curing should not be used because of differential heating
- Coefficient of thermal expansion matching is critical

Component Pickup and Placement:

- Vacuum pencil and/or vacuum collet preferred method of pick up
- Avoidance of air bridges during placement
- Force impact critical during auto placement

Interconnect:

- Thermosonic ball bonding is the preferred interconnect technique
- Force, time, and ultrasonics are critical parameters
- Aluminum wire should not be used
- Discrete FET devices with small pad sizes should be bonded with 0.0007-inch wire
- Maximum stage temperature: 200°C

TGA4807 Mechanical Drawing

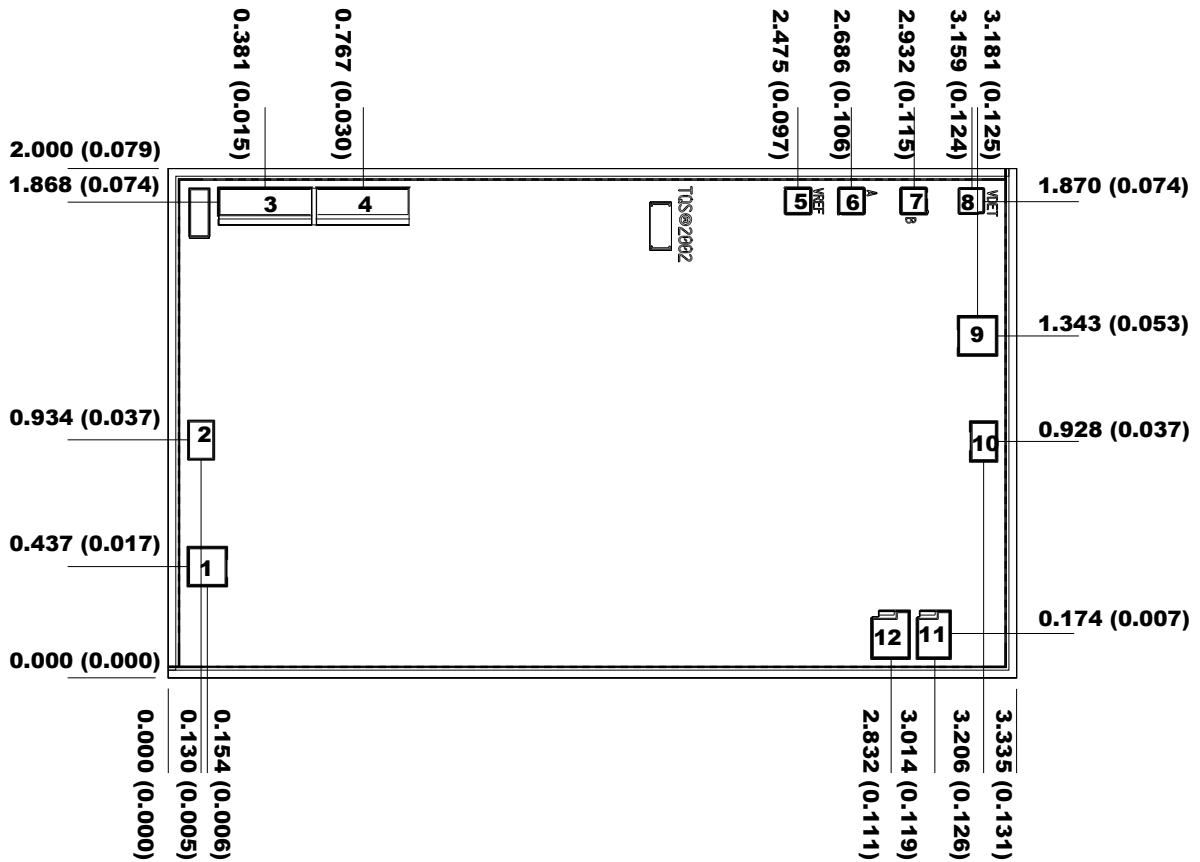

Units: millimeters (inches)

Thickness: 0.100 (0.004)

Chip edge to bond pad dimensions are shown to center of bond pad

Chip size tolerance: +/- 0.051 (0.002)

RF GND IS BACKSIDE OF MMIC

Bond pad #1	(RF In)	0.155 x 0.155 (0.006 x 0.006)
Bond pad #2	(Vctrl)	0.106 x 0.157 (0.004 x 0.006)
Bond pad #3	(V+)	0.368 x 0.109 (0.014 x 0.004)
Bond pad #4	(V+ aux)	0.368 x 0.109 (0.014 x 0.004)
Bond pad #5	(Vref)	0.095 x 0.095 (0.004 x 0.004)
Bond pad #6	(A)	0.095 x 0.095 (0.004 x 0.004)
Bond pad #7	(B)	0.095 x 0.095 (0.004 x 0.004)
Bond pad #8	(V det)	0.095 x 0.095 (0.004 x 0.004)
Bond pad #9	(RF Out)	0.155 x 0.155 (0.006 x 0.006)
Bond pad #10	(Vctrl aux)	0.106 x 0.157 (0.004 x 0.006)
Bond pad #11	(Vg aux)	0.155 x 0.155 (0.006 x 0.006)
Bond pad #12	(Vg)	0.155 x 0.155 (0.006 x 0.006)