

30 - 40 GHz 180° Phase Shifter

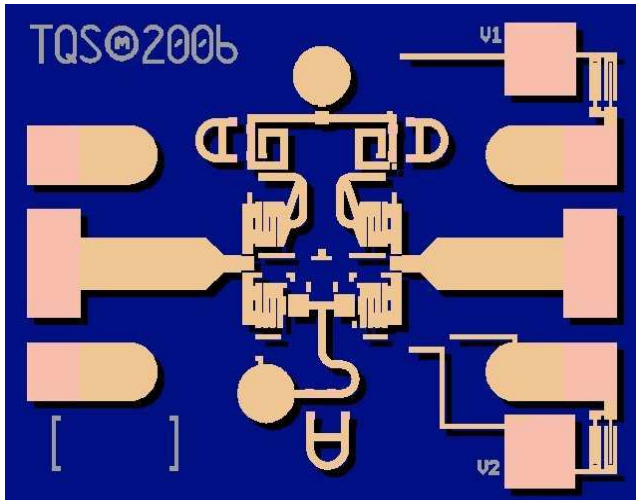

Key Features and Performance

- Frequency Range: 30-40 GHz
- 3.5 dB Nominal Insertion Loss
- 10 deg Phase Error @ 35 GHz
- 0.1 dB Amplitude Error @ 35 GHz
- Positive Control Voltage
- 0.25µm 3MI pHEMT Technology
- Chip dimensions:
0.93 x 0.74 x 0.10 mm
(0.037 x 0.029 x 0.004 inches)

Primary Applications

- Military Radar
- Transmit / Receive

Product Description

The TriQuint TGP2104 is a 180° digital phase shifter MMIC design using TriQuint’s proven 0.25 µm Three Metal Interconnect (3MI) pHEMT process. The TGP2104 will support a variety of Ka-Band phased array applications including military radar.

This design utilizes a compact topology that achieves a 0.69 mm² die area and high performance.

The TGP2104 provides a 180° digital phase shift function with a nominal 3.5 dB insertion loss and maximum 15° phase shift error over a bandwidth of 30-40 GHz.

The TGP2104 requires no off-chip components and operates with a 5V control voltage. Each device is RF tested on-wafer to ensure performance compliance. The device is available in chip form.

Lead-Free and RoHS compliant

Measured Performance

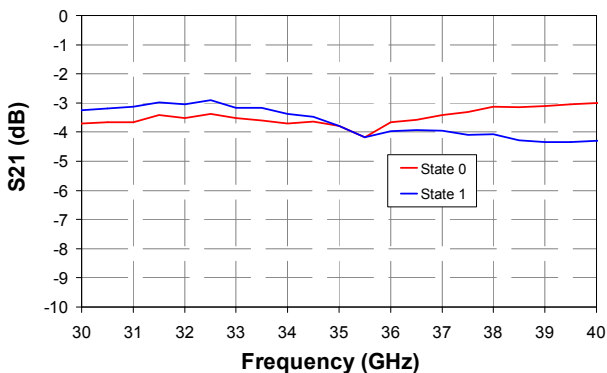
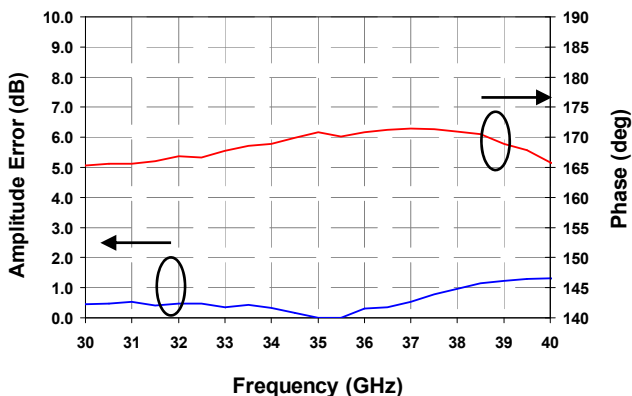

Datasheet subject to change without notice

**TABLE I
MAXIMUM RATINGS**

Symbol	Parameter	Value	Notes
V_1, V_2	Control Voltage	8 V	<u>1/</u> <u>2/</u>
I_C	Control Supply Current	1 mA	<u>1/</u> <u>2/</u>
P_{IN}	Input Continuous Wave Power	20 dBm	<u>1/</u> <u>2/</u>
P_D	Power Dissipation	0.392 W	<u>1/</u> <u>2/</u>
T_{CH}	Operating Channel Temperature	200 °C	<u>3/</u>
	Mounting Temperature (30 Seconds)	320 °C	
T_{STG}	Storage Temperature	-65 to 150 °C	

- 1/ These ratings represent the maximum operable values for this device
- 2/ Combinations of supply voltage, supply current, input power, and output power shall not exceed P_D
- 3/ Junction operating temperature will directly affect the device median time to failure (T_m). For maximum life, it is recommended that junction temperatures be maintained at the lowest possible levels.

TABLE II
RF CHARACTERIZATION TABLE
 (T_A = 25°C, Nominal)
 (V₁=V₂ = 5V)

Parameter	Test Conditions	Typ	Units
Insertion Loss	30 - 40 GHz	3.5	dB
Max Amplitude Error	30 - 40 GHz	1	dB
Max Phase Shift Error	30 - 40 GHz	15	deg
Input Return Loss	30 - 40 GHz	12	dB
Output Return Loss	30 - 40 GHz	12	dB

Note: The RF Characteristics of typical devices are determined by fixtured measurements.

State Table

State	V1	V2	Phase shift
0	5 V	0 V	Reference
1	5 V	5 V	180°

TABLE III
Thermal Information

Parameter	Test Conditions	Tch (°C)	θ_{JC} (°C/W)	Tm (hrs)
θ_{JC} Thermal Resistance (channel to backside of die)	$V_1 = V_2 = 5\text{ V}$ $I_2 = 10\text{ }\mu\text{A}$ $P_{diss} = 50\text{ }\mu\text{W}$ $T_{baseplate} = 70\text{ C}$	70	204	>1 E 9

Median Lifetime (Tm) vs. Channel Temperature

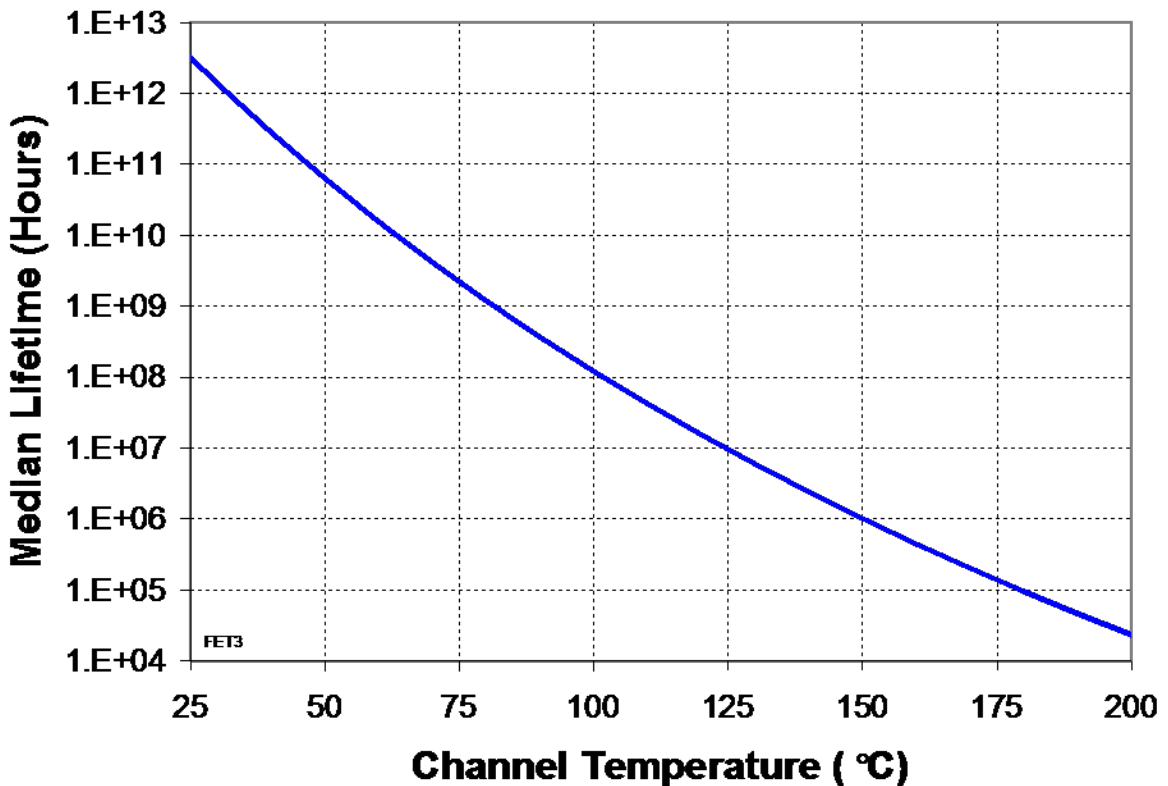

Measured Data

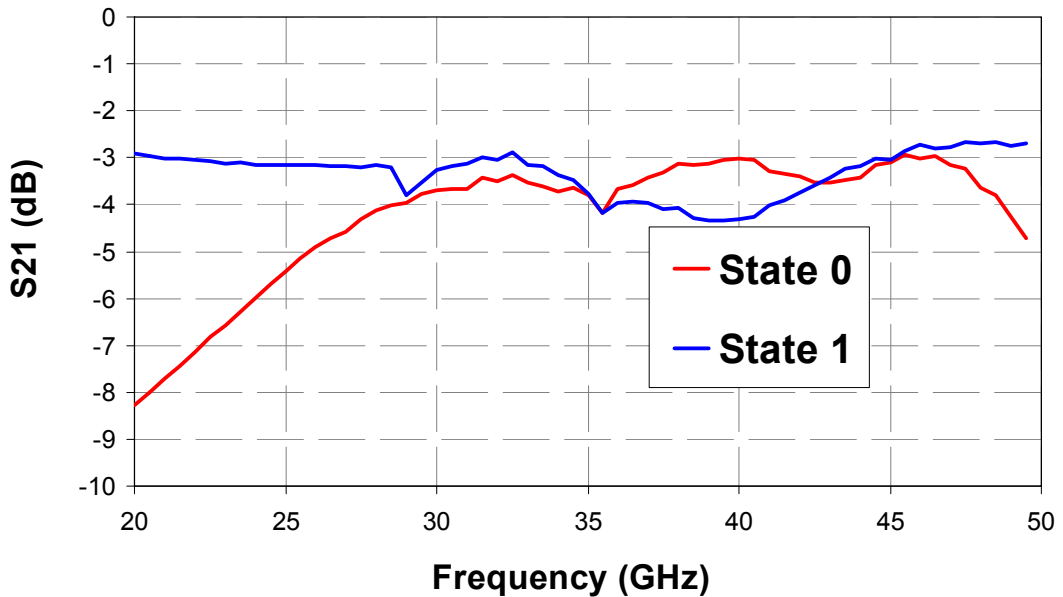
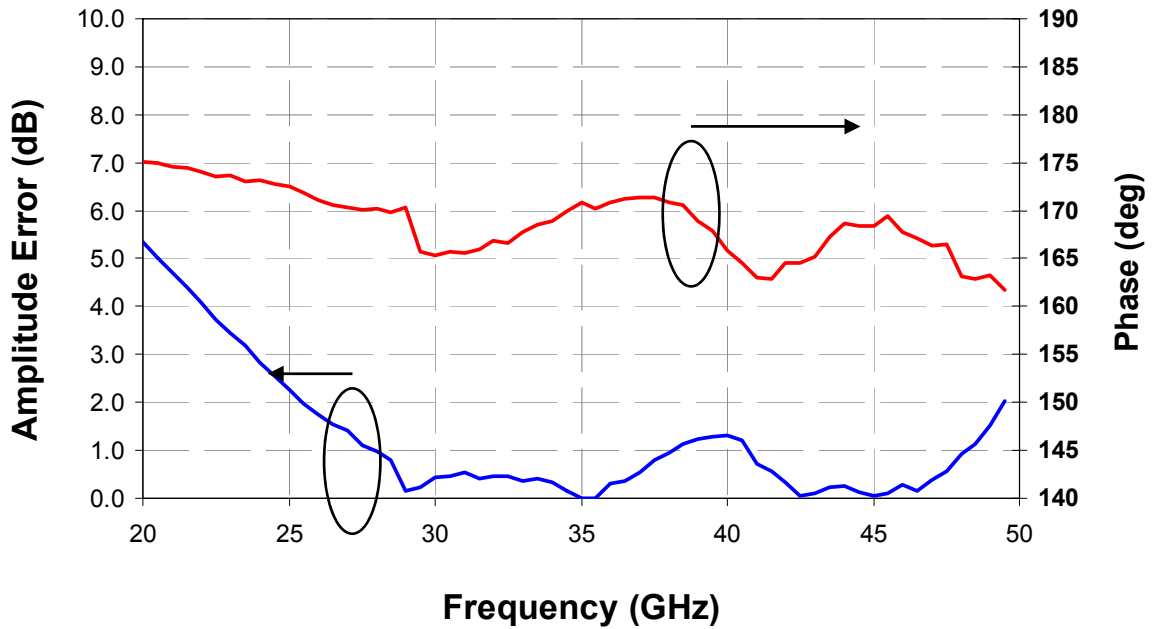

Measured Data

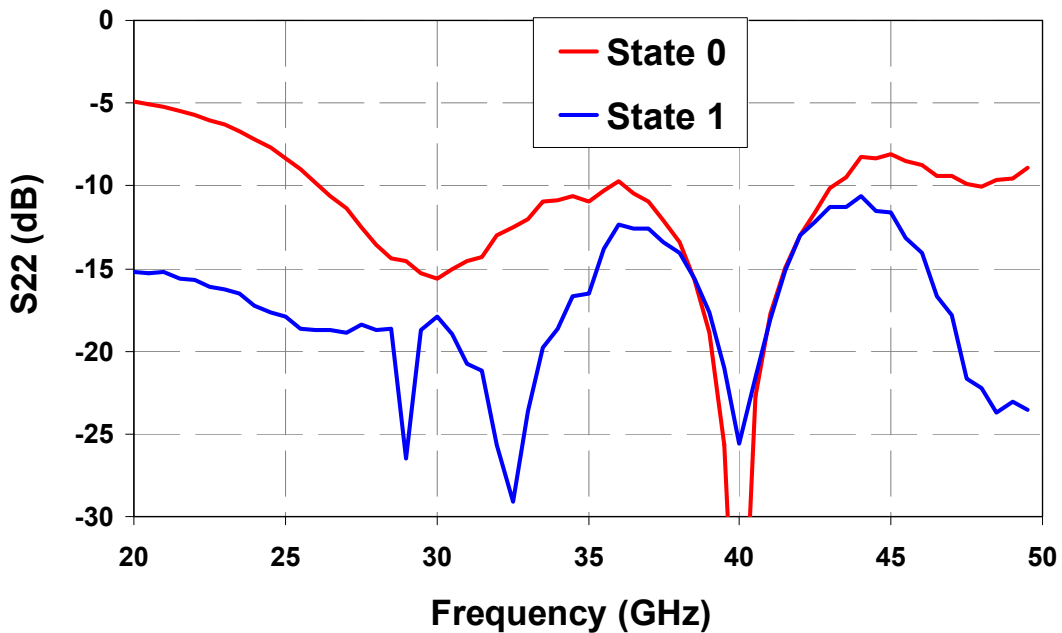
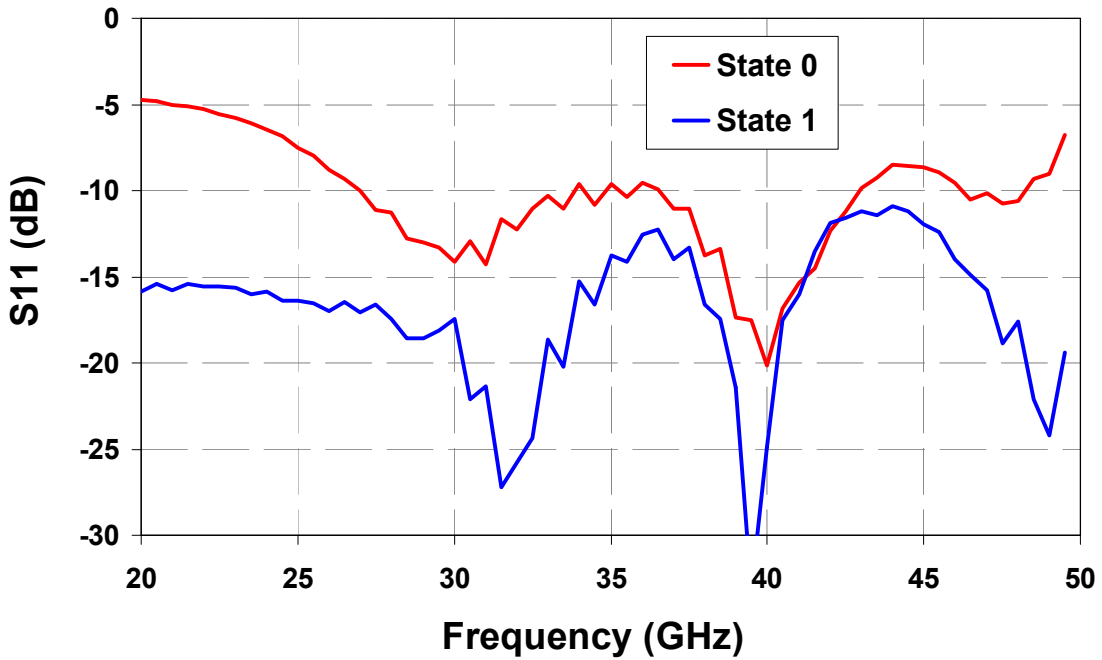

Mechanical Drawing

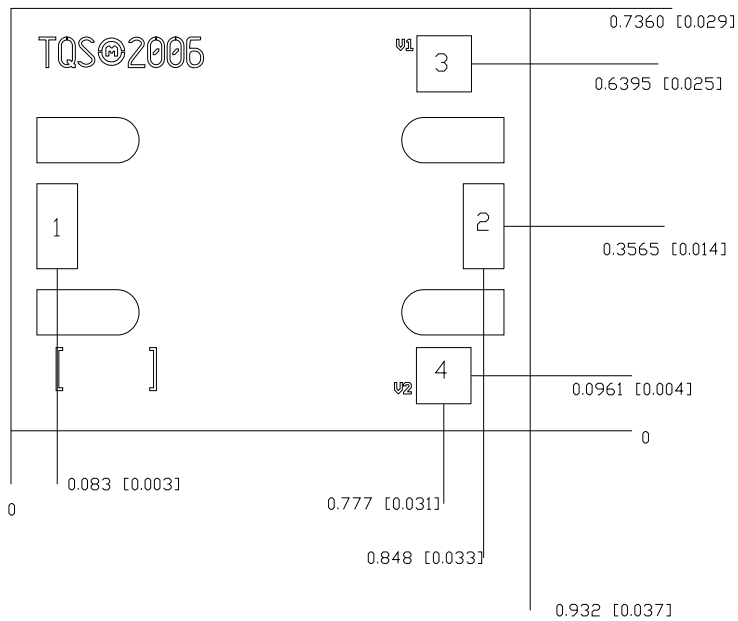

Units: millimeters (inches)

Thickness: 0.102 (0.004) (reference only)

Chip edge to bond pad dimensions are shown to center of Bond pads.

Chip size tolerance: ± 0.051 (0.002)

RF Ground through Backside

Bond Pad #1 (RF Input)	0.076 x 0.150	(0.003 x 0.006)
Bond Pad #1 (RF Output)	0.076 x 0.150	(0.003 x 0.006)
Bond Pad #3 (V1)	0.100 x 0.100	(0.004 x 0.004)
Bond Pad #4 (V2)	0.100 x 0.100	(0.004 x 0.004)

Chip Assembly & Bonding Diagram

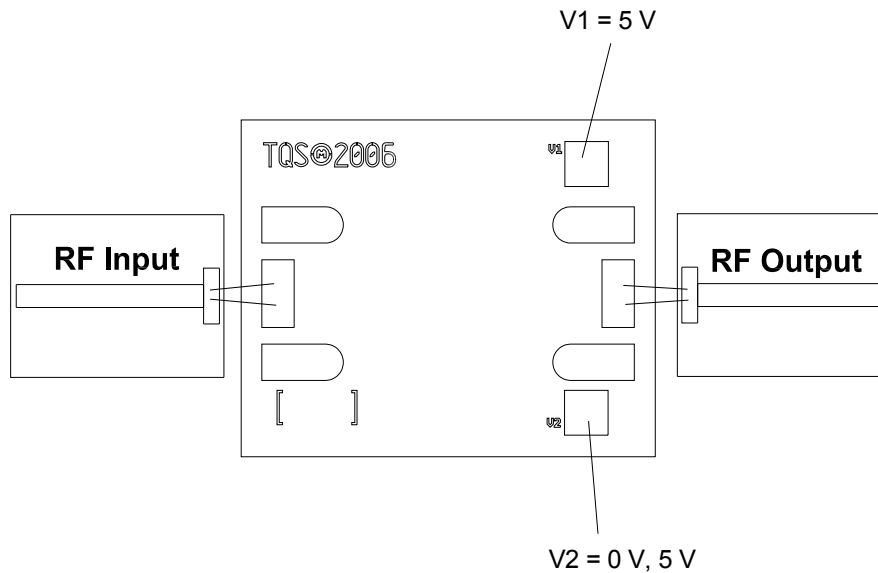

- RF Input and Output should have two 1 mil bond wires
- Input and Output Flares are 0.010" x 0.025" on 0.010" alumina substrate

GaAs MMIC devices are susceptible to damage from Electrostatic Discharge. Proper precautions should be observed during handling, assembly and test.

Assembly Process Notes

Reflow process assembly notes:

- Use AuSn (80/20) solder with limited exposure to temperatures at or above 300°C. (30 seconds maximum)
- An alloy station or conveyor furnace with reducing atmosphere should be used.
- No fluxes should be utilized.
- Coefficient of thermal expansion matching is critical for long-term reliability.
- Devices must be stored in a dry nitrogen atmosphere.

Component placement and adhesive attachment assembly notes:

- Vacuum pencils and/or vacuum collets are the preferred method of pick up.
- Air bridges must be avoided during placement.
- The force impact is critical during auto placement.
- Organic attachment can be used in low-power applications.
- Curing should be done in a convection oven; proper exhaust is a safety concern.
- Microwave or radiant curing should not be used because of differential heating.
- Coefficient of thermal expansion matching is critical.

Interconnect process assembly notes:

- Thermosonic ball bonding is the preferred interconnect technique.
- Force, time, and ultrasonics are critical parameters.
- Aluminum wire should not be used.
- Maximum stage temperature is 200°C.

GaAs MMIC devices are susceptible to damage from Electrostatic Discharge. Proper precautions should be observed during handling, assembly and test.