

Data Sheet

Features

- For WLAN applications
- Usable bandwidth of 17 MHz
- High attenuation
- Balanced or Single-ended operation
- Ceramic Surface Mount Package (SMP)
- Hermetic
- RoHS compliant (2002/95/EC), Pb-free 

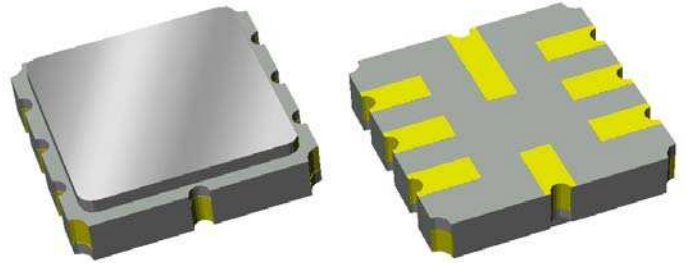

Package

Surface Mount 5.00 x 5.00 x 1.32 mm

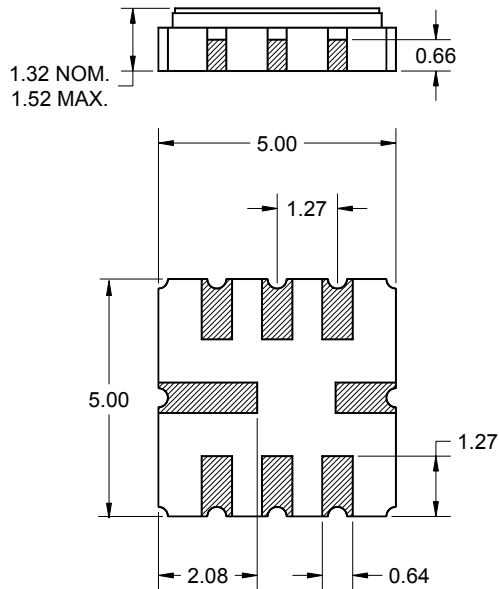

Pin Configuration

Bottom View

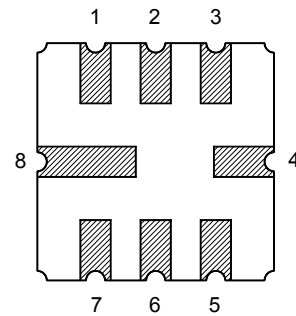

Pin No.	Description
2	Input return
3	Input
6	Output return
7	Output
1,4,5,8	Case Ground

Dimensions shown are nominal in millimeters
 All tolerances are ± 0.15 mm except overall
 length and width $\pm 0.15/\pm 0.10$ mm

Body: Al_2O_3 ceramic
 Lid: Kovar, Ni plated
 Terminations: Au plating 0.5 - 1.0 μ m,
 over a 2 - 6 μ m Ni plating

Data Sheet

Electrical Specifications ⁽¹⁾

Operating Temperature Range: ⁽²⁾ -10 to +80 °C

Parameter ⁽³⁾	Minimum	Typical	Maximum	Unit
Center Frequency, f_0	-	374	-	MHz
Minimum Insertion Loss	-	8.5	10.5	dB
3 dB Bandwidth	17	20.5	-	MHz
Relative Attenuation ⁽⁴⁾				
309 - 352 MHz	40	50	-	dB
352 - 357.5 MHz	35	50	-	dB
390.5 - 392 MHz	35	45	-	dB
392 - 396 MHz	35	40	-	dB
396 - 439 MHz	38	42	-	dB
439 - 454 MHz	40	45	-	dB
Passband Variation	-	0.5	1.0	dB
Group Delay Variation	-	40	100	nsec
Triple Transit Suppression	30	40	-	dB
Optimal Source Impedance: ⁽⁵⁾	-	50	-	Ω
Optimal Load Impedance: ⁽⁵⁾	-	50	-	Ω

Notes:

1. All specifications are based on the test circuit shown below
2. In production, devices will be tested at room temperature to a guardbanded specification to ensure electrical compliance over temperature
3. Electrical margin has been built into the design to account for the variations due to temperature drift and manufacturing tolerances
4. Relative to minimum insertion loss
5. Sawtek's production specifications reflect the typical performance in a 50 ohm single-ended system. This filter can be used in both single-ended and/or differential modes at each port. In addition, similar performance can be achieved in source and load impedances ranging from 50 to 1000.

Test Circuit:

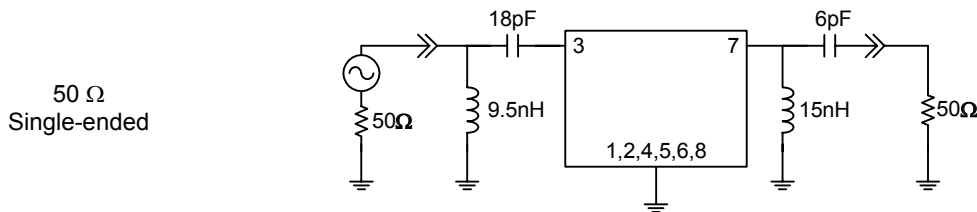

Data Sheet

Typical Performance (at +25°C)

Frequency Response

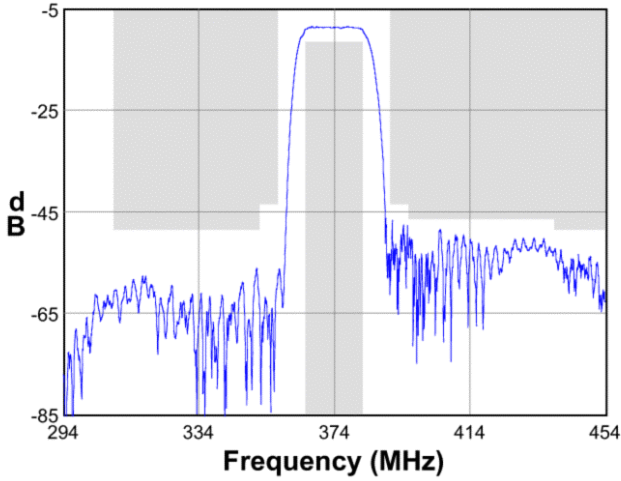

Passband Response

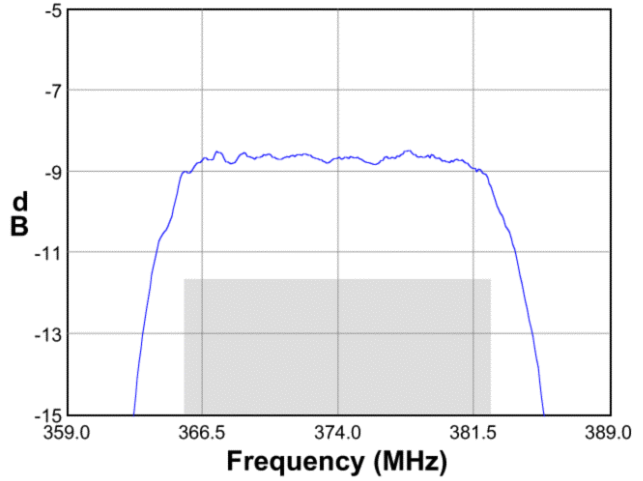

Wideband Response

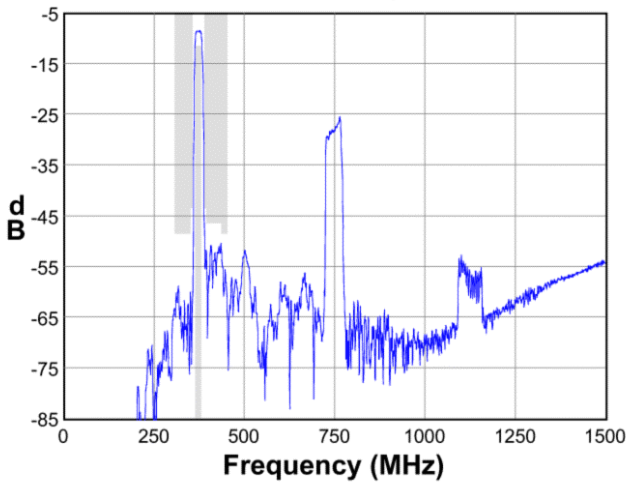

Group Delay Variation

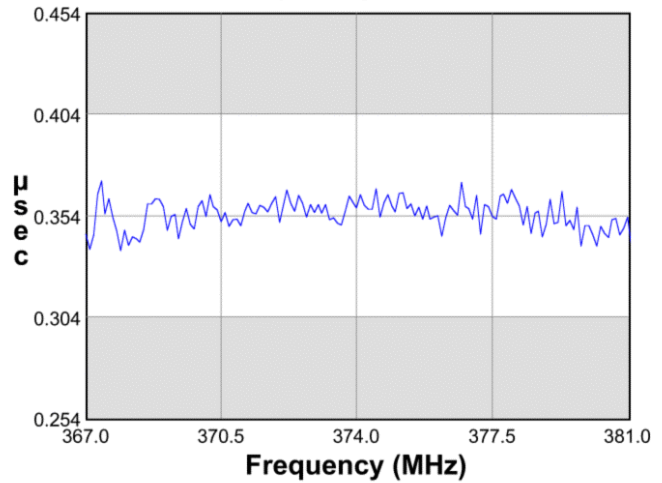

Input Smith Chart

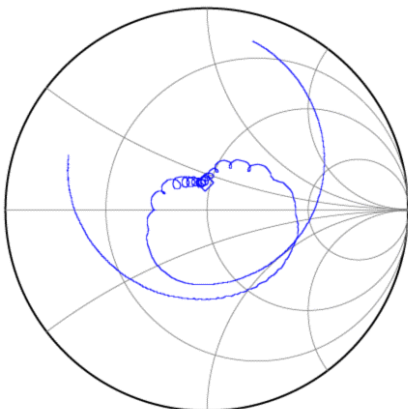

Output Smith Chart

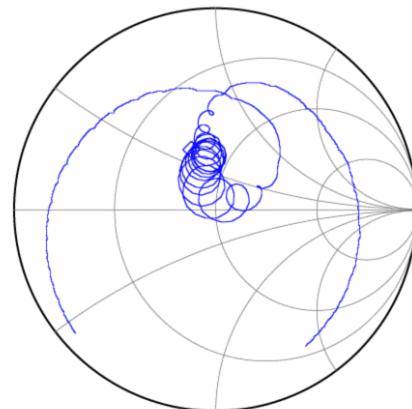

Data Sheet

Matching Schematics

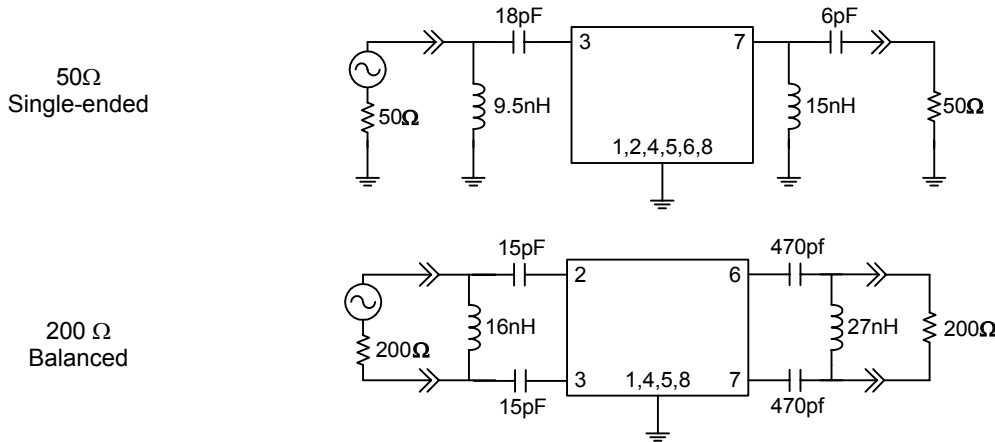

Marking

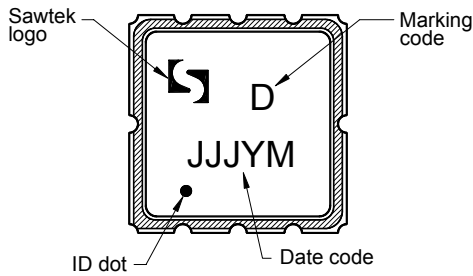

The date code consists of: JJJ = Julian day,
Y = last digit of year, M = manufacturing site code

PCB Footprint

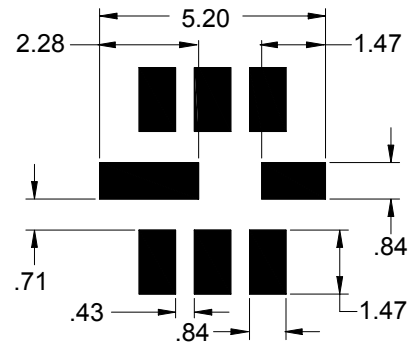

This footprint represents a recommendation only
Dimensions shown are nominal in millimeters

Tape and Reel

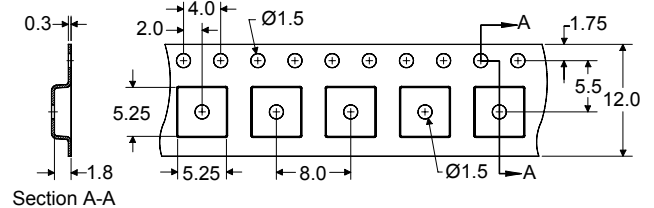
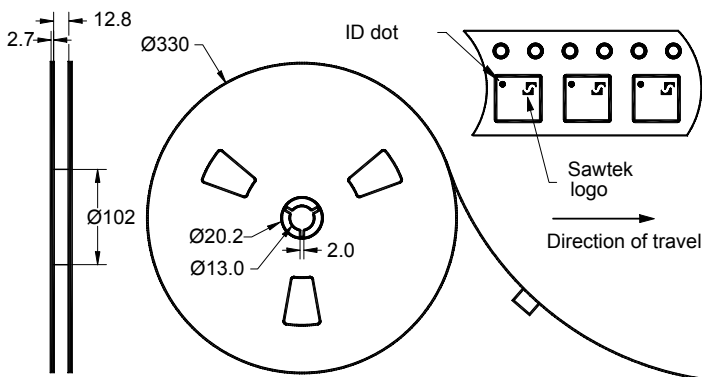

Dimensions shown are nominal in millimeters
Packaging quantity: 4000 units/reel

Data Sheet

Maximum Ratings

Parameter	Symbol	Minimum	Maximum	Unit
Operating Temperature Range	T	-10	+80	°C
Storage Temperature Range	T _{stg}	-40	+85	°C

Important Notes

Warnings

- Electrostatic Sensitive Device (ESD) 
- Avoid ultrasonic exposure

RoHS Compliance

- This product complies with EU directive 2002/95/EC (RoHS) 

Solderability

- Compatible with JEDEC J-STD-020C **Pb**-free process, **260°C** peak reflow temperature ([see soldering profile](#))

Links to Additional Technical Information

[PCB Layout Tips](#)

[Qualification Flowchart](#)

[Soldering Profile](#)

[S-Parameters](#)

[RoHS Information](#)

[Other Technical Information](#)

Sawtek's liability is limited only to the Surface Acoustic Wave (SAW) component(s) described in this data sheet. Sawtek does not accept any liability for applications, processes, circuits or assemblies, which are implemented using any Sawtek component described in this data sheet.

Contact Information



PO Box 609501
 Orlando, FL 32860-9501
 USA

Phone: +1 (407) 886-8860
 Fax: +1 (407) 886-7061
 Email: custservice@sawtek.com
 Web: www.sawtek.com

Or contact one of our worldwide
 Network of [sales offices](#),
[representatives or distributors](#)