

Data Sheet

Features

- For GPS applications
- Usable bandwidth 2.4 MHz
- Low loss
- No impedance matching required for operation at 50 Ω
- Single-ended operation
- Ceramic Surface Mount Package (SMP)
- Hermetic
- RoHS compliant (2002/95/EC), Pb-free 

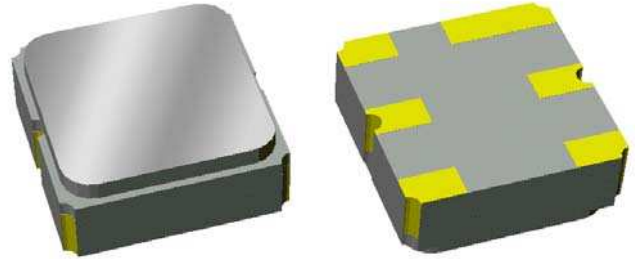

Package

Surface Mount 3.00 x 3.00 x 1.22 mm

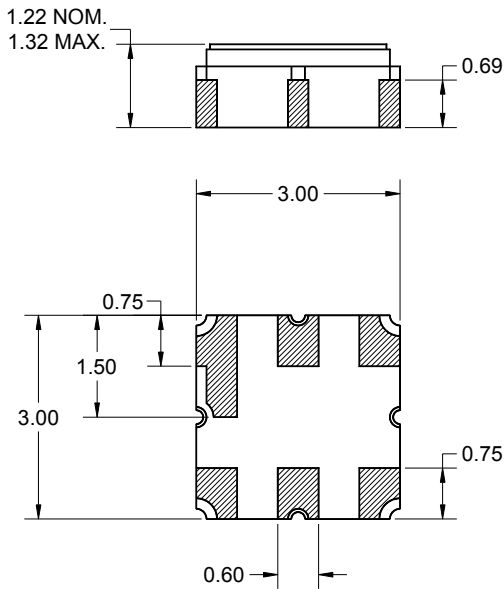

Pin Configuration

Bottom View

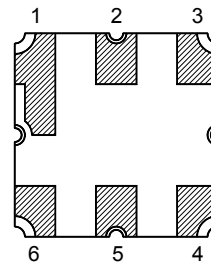

Pin No.	Description
2,5	Input/Output
1,3,4,6	Case ground

Dimensions shown are nominal in millimeters
 All tolerances are ±0.15mm except overall
 length and width ±0.10mm

Body: Al_2O_3 ceramic
 Lid: Kovar, Ni plated
 Terminations: Au plating 0.5 - 1.0μm,
 over a 2 - 6μm Ni plating

Data Sheet

Electrical Specifications ⁽¹⁾

Operating Temperature Range: ⁽²⁾ -40 to +85 °C

Parameter ⁽³⁾	Minimum	Typical	Maximum	Unit
Center Frequency	-	1575.42	-	MHz
Maximum Insertion Loss 1574.22 - 1576.62 MHz	-	1.3	1.8	dB
Passband Ripple 1574.22 - 1576.62 MHz	-	0.3	1	dB p-p
Absolute Attenuation				
10 - 1450 MHz	40	42	-	dB
1450 - 1500 MHz	30	45	-	dB
1625 - 1640 MHz	30	58	-	dB
1640 - 2000 MHz	45	49	-	dB
2000 - 3000 MHz	30	35	-	dB
Input/Output VSWR 1574.22 - 1576.62 MHz	-	1.2:1	2:1	dB
Source Impedance: ⁽⁴⁾	-	50	-	Ω
Load Impedance: ⁽⁴⁾	-	50	-	Ω

Notes:

1. All specifications are based on the test circuit shown below
2. In production, devices will be tested at room temperature to a guardbanded specification to ensure electrical compliance over temperature
3. Electrical margin has been built into the design to account for the variations due to temperature drift and manufacturing tolerances
4. This is the optimum impedance in order to achieve the performance shown

Test Circuit:

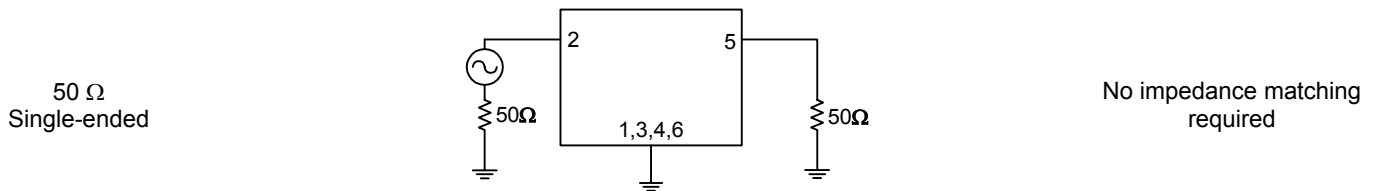

Data Sheet

Typical Performance (at +25°C)

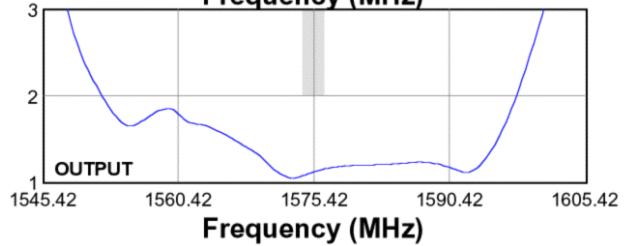
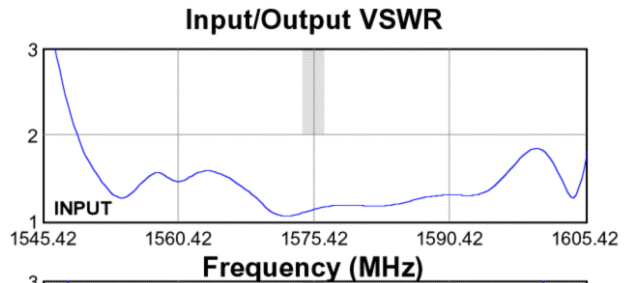
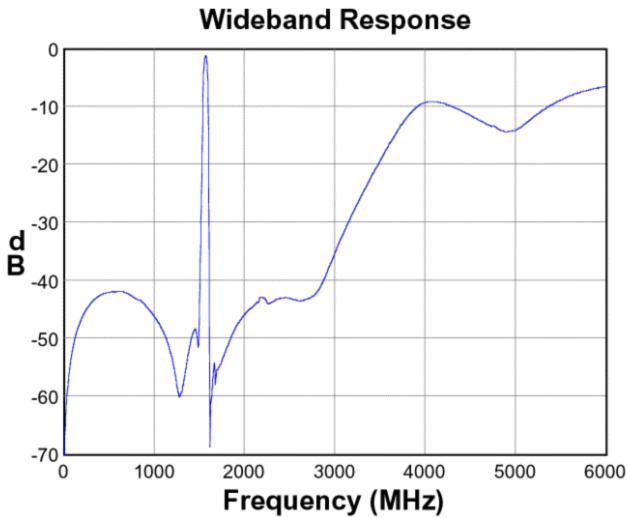
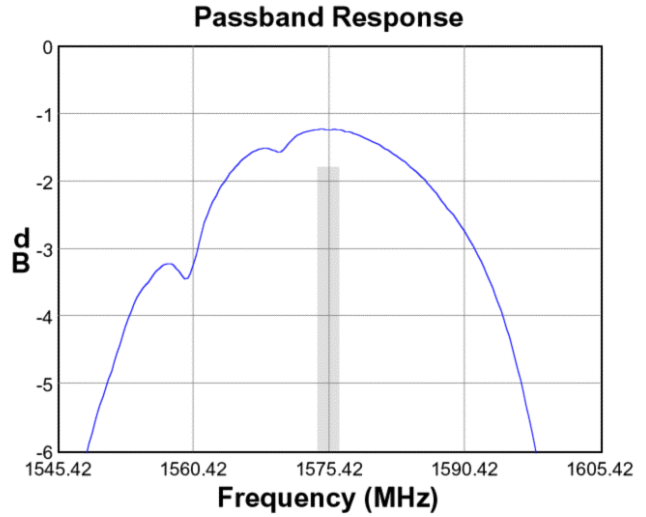
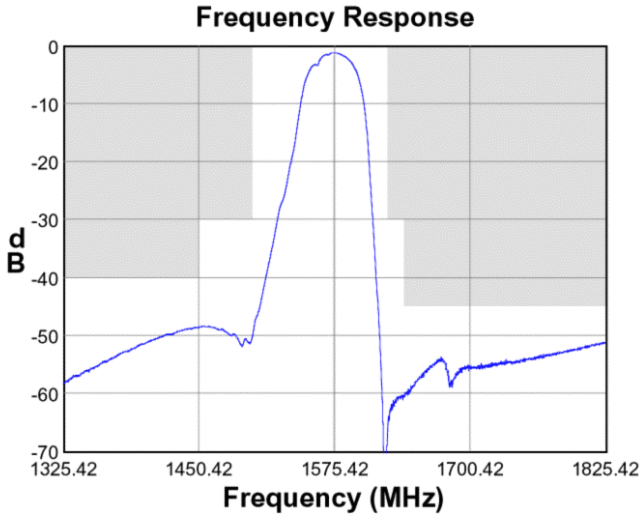

Input Smith Chart

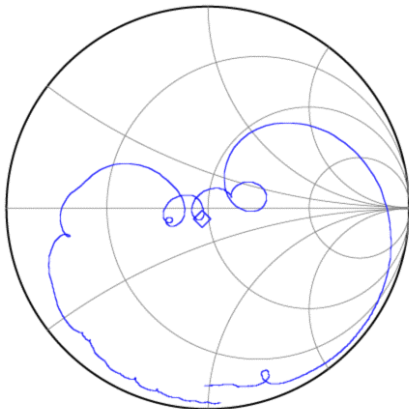

Output Smith Chart

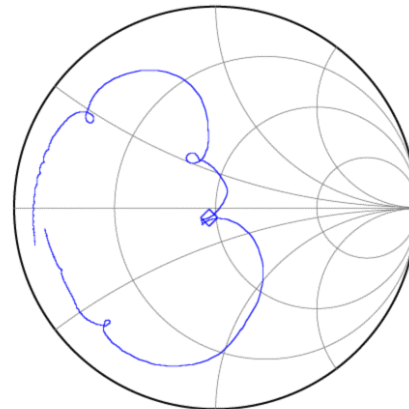

Data Sheet

Matching Schematics

50 Ω
Single-ended

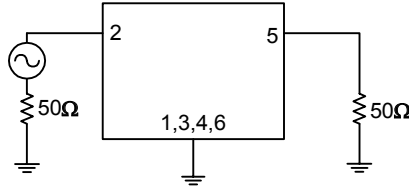

No impedance matching required

Marking PCB Footprint

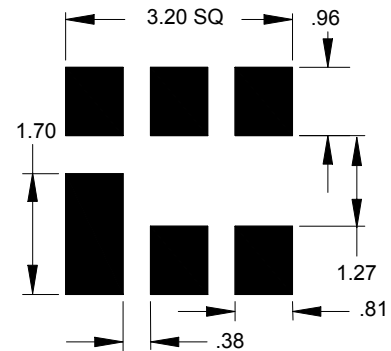
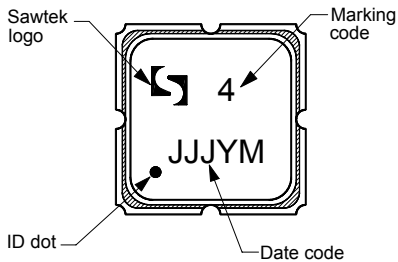

The date code consists of: JJJ = Julian day,
Y = last digit of year, M = manufacturing site code

This footprint represents a recommendation only
Dimensions shown are nominal in millimeters

Tape and Reel

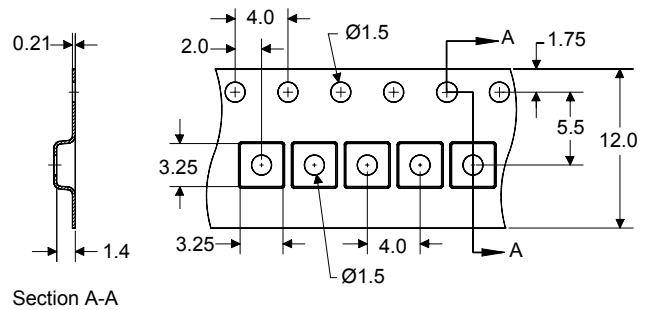
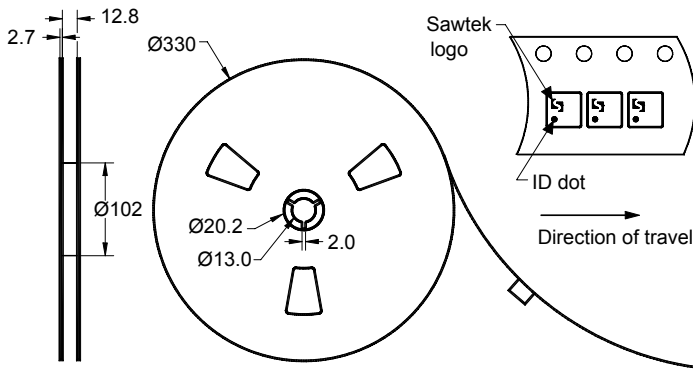

Dimensions shown are nominal in millimeters
Packaging quantity: 5000 units/reel

Data Sheet

Maximum Ratings

Parameter	Symbol	Minimum	Maximum	Unit
Operating Temperature Range	T	-40	+85	°C
Storage Temperature Range	T _{stg}	-40	+85	°C
RF Power	P _{in}	-	+10	dBm

Important Notes

Warnings

- Electrostatic Sensitive Device (ESD) 
- Avoid ultrasonic exposure

RoHS Compliance

- This product complies with EU directive 2002/95/EC (RoHS) 

Solderability

- Compatible with JEDEC J-STD-020C **Pb**-free process, **260°C** peak reflow temperature ([see soldering profile](#))

Links to Additional Technical Information

[PCB Layout Tips](#)

[Qualification Flowchart](#)

[Soldering Profile](#)

[S-Parameters](#)

[RoHS Information](#)

[Other Technical Information](#)

Sawtek's liability is limited only to the Surface Acoustic Wave (SAW) component(s) described in this data sheet. Sawtek does not accept any liability for applications, processes, circuits or assemblies, which are implemented using any Sawtek component described in this data sheet.

Contact Information



PO Box 609501
Orlando, FL 32860-9501
USA

Phone: +1 (407) 886-8860
Fax: +1 (407) 886-7061
Email: custservice@sawtek.com
Web: www.sawtek.com

Or contact one of our worldwide
Network of [sales offices](#),
[representatives or distributors](#)