

# Preliminary Data Sheet

## Features

- For IF applications
- Typical 3 dB bandwidth of 0.75 MHz
- High attenuation
- Single-ended operation
- Ceramic Surface Mount Package (SMP)
- Replaces Sawtek P/N 851902 (BW 3dB = 0.75MHz)
- Hermetic
- RoHS compliant (2002/95/EC), Pb-free 

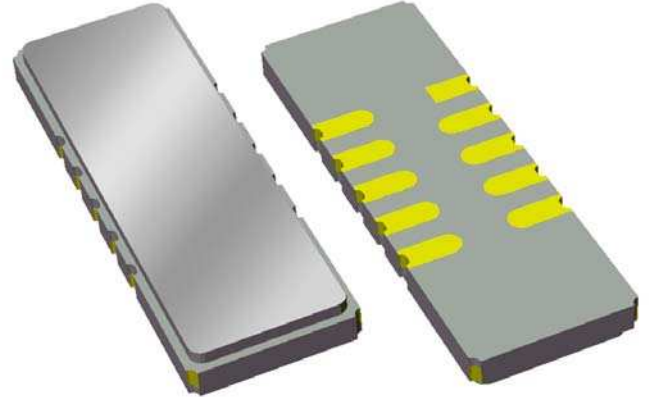

## Package

Surface Mount 19.00 x 6.50 x 1.75 mm

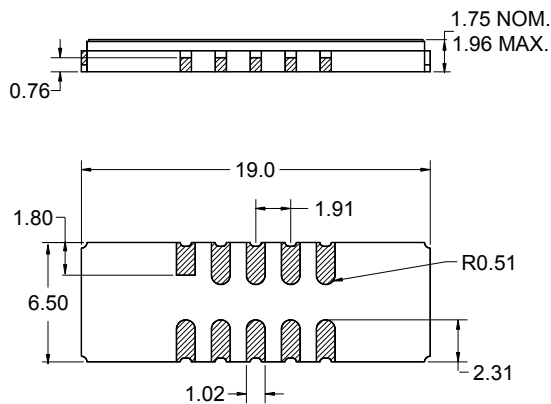

## Pin Configuration

Bottom View

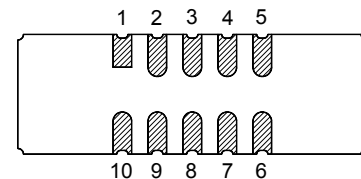

Pin No.	Description
5	RF output
10	RF input
1,6	Ground
2,3,4	Case ground
7,8,9	Case ground

Dimensions shown are nominal in millimeters  
All tolerances are  $\pm 0.15$ mm except overall  
length and width  $+0.15$ mm/ $-0.10$ mm

Body:  $Al_2O_3$  ceramic  
Lid: Kovar, Ni plated  
Terminations: Au plating 0.5 - 1.0 $\mu$ m,  
over a 2 - 6 $\mu$ m Ni plating

# Preliminary Data Sheet

## Electrical Specifications <sup>(1)</sup>

Operating Temperature Range: <sup>(2)</sup> 0 to +70 °C

Parameter <sup>(3)</sup>	Minimum	Typical	Maximum	Unit
<b>Center Frequency</b>	-	140	-	MHz
<b>Minimum Insertion Loss</b>	-	20.8	23	dB
<b>Lower 1 dB Bandedge</b> <sup>(4)</sup>	-	139.722	139.805	MHz
<b>Upper 1 dB Bandedge</b>	140.195	140.264	-	MHz
<b>Lower 3 dB Bandedge</b> <sup>(4)</sup>	-	139.606	139.676	MHz
<b>Upper 3 dB Bandedge</b>	140.324	140.376	-	MHz
<b>Lower 40 dB Bandedge</b> <sup>(4)</sup>	139.035	139.123	-	MHz
<b>Upper 40 dB Bandedge</b>	-	140.912	140.965	MHz
<b>Amplitude Variation</b> 139.805 - 140.195 MHz	-	0.44	1	dB p-p
<b>Phase Linearity</b> 139.805 - 140.195 MHz	-	0.95	4	deg p-p
<b>Group Delay Variation</b> 139.805 - 140.195 MHz	-	62	240	ns p-p
<b>Relative Attenuation</b> <sup>(4)</sup>				
15 - 138.5 MHz	50	59.6	-	dB
141.5 - 155 MHz	43	54.5	-	dB
155 - 219 MHz	48	59.3	-	dB
219 - 239 MHz	-	13.8	-	dB
239 - 248 MHz	48	62.6	-	dB
248 - 268 MHz	-	14.0	-	dB
268 - 350 MHz	50	66.0	-	dB
<b>Terminating Source Impedance</b> <sup>(5)</sup>	-	50	-	Ω
<b>Terminating Load Impedance</b> <sup>(5)</sup>	-	50	-	Ω

### Notes:

- All specifications are based on the test circuit shown below
- In production, devices will be tested at room temperature to a guardbanded specification to ensure electrical compliance over temperature
- Electrical margin has been built into the design to account for the variations due to temperature and manufacturing tolerances
- All attenuation measurements are measured relative to minimum insertion loss
- This is the optimum impedance in order to achieve the performance shown

### Test Circuit:

Actual matching values may vary due to PCB layout and parasitics

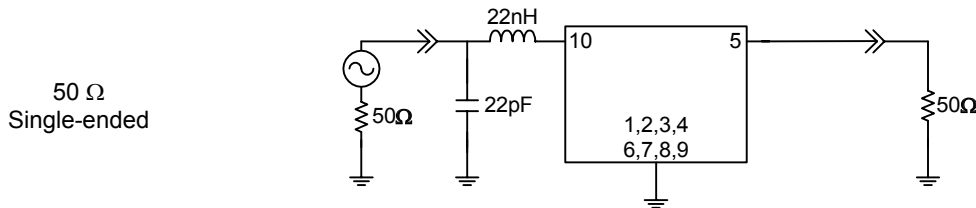

**Preliminary Data Sheet**

**Typical Performance (at +25°C)**

**Frequency Response**

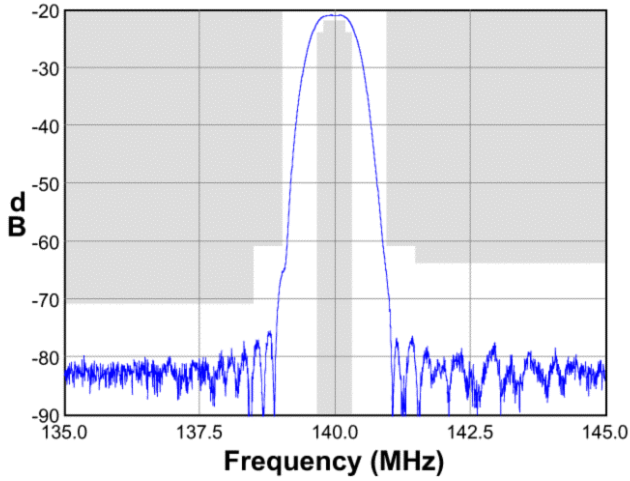

**Passband Response**

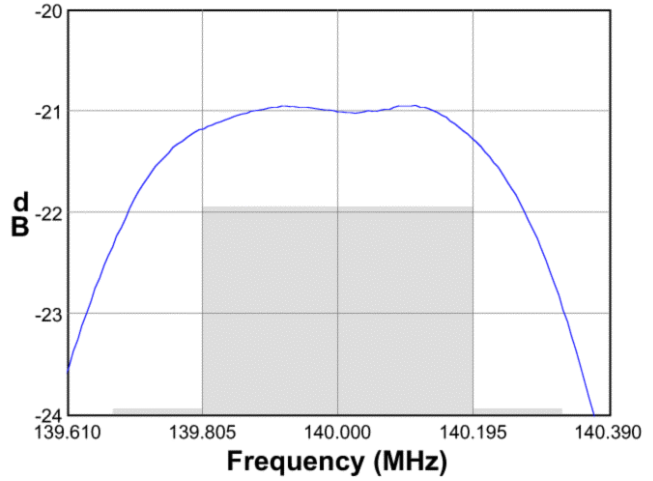

**Wideband Response**

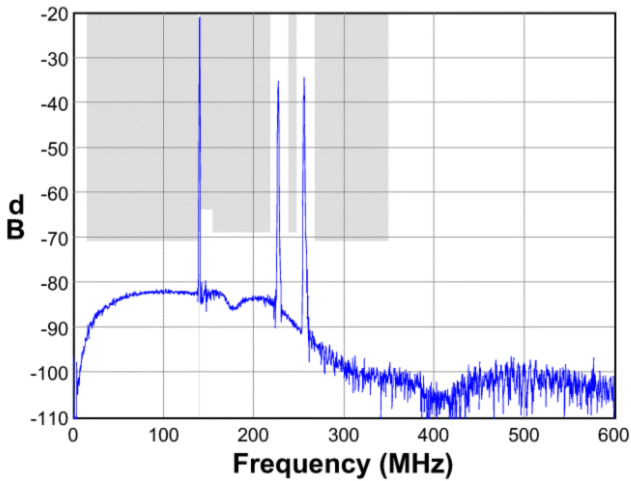

**Phase Linearity**

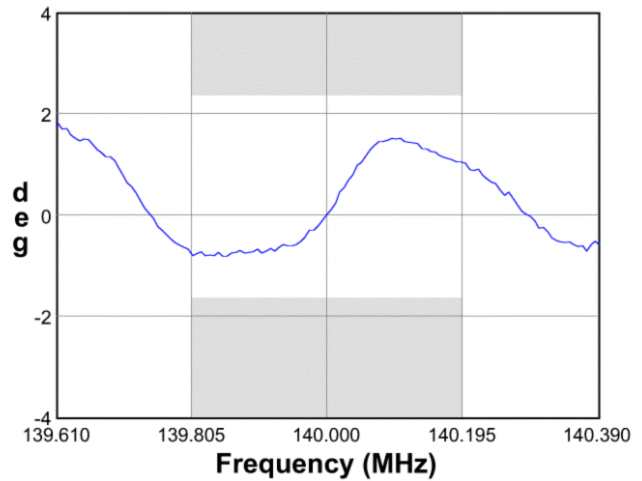

**Input Smith Chart**

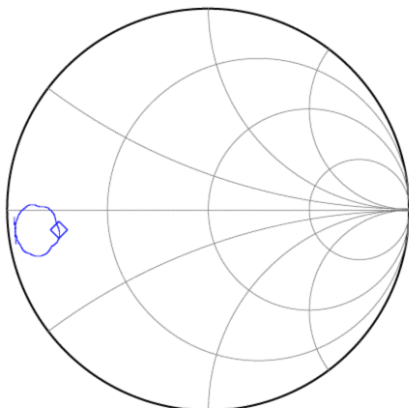

**Output Smith Chart**

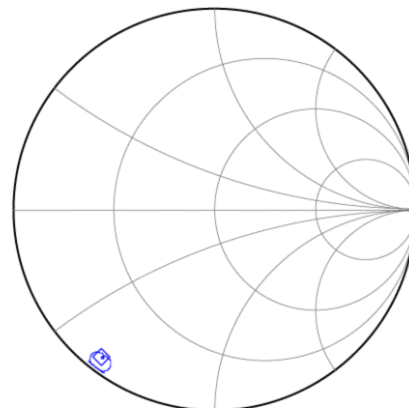

**Preliminary Data Sheet**

**Matching Schematics**

Actual matching values may vary due to PCB layout and parasitics

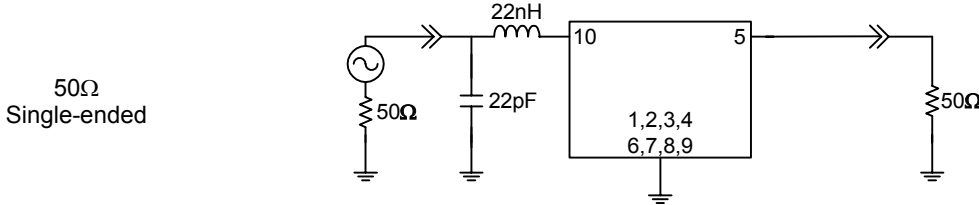

**Marking**

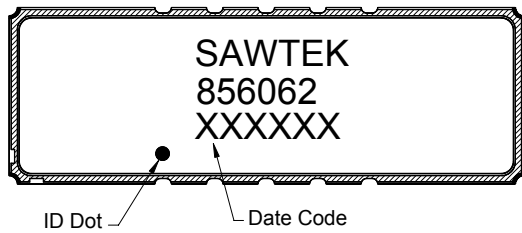

The date code consists of: day of the current year (Julian, 3 digits), last digit of the year (1 digit) and hour (2 digits)

**PCB Footprint**

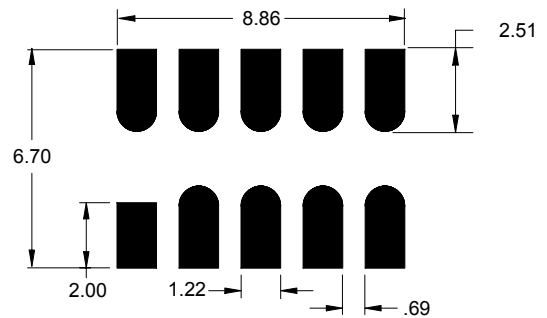

This footprint represents a recommendation only  
Dimensions shown are nominal in millimeters

**Tape and Reel**

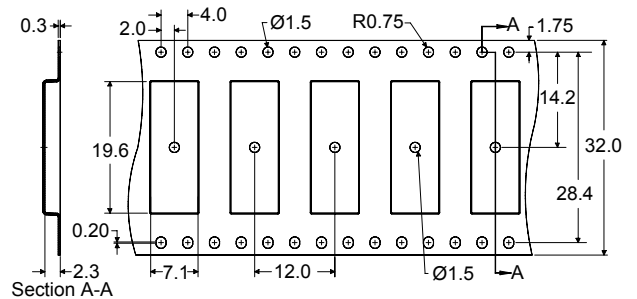
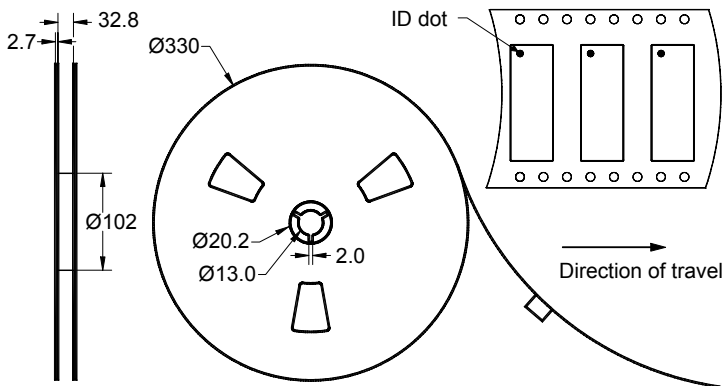

Dimensions shown are nominal in millimeters  
Packaging quantity: 2000 units/reel

# Preliminary Data Sheet

## Maximum Ratings

Parameter	Symbol	Minimum	Maximum	Unit
Operating Temperature Range	T	0	+70	°C
Storage Temperature Range	T <sub>stg</sub>	-40	+85	°C

## Important Notes

### Warnings

- Electrostatic Sensitive Device (ESD) 
- Avoid ultrasonic exposure

### RoHS Compliance

- This product complies with EU directive 2002/95/EC (RoHS) 

### Solderability

- Compatible with JEDEC J-STD-020C **Pb**-free process, **260°C** peak reflow temperature ([see soldering profile](#))

## Links to Additional Technical Information

[PCB Layout Tips](#)

[Qualification Flowchart](#)

[Soldering Profile](#)

[S-Parameters](#)

[RoHS Information](#)

[Other Technical Information](#)

Sawtek's liability is limited only to the Surface Acoustic Wave (SAW) component(s) described in this data sheet. Sawtek does not accept any liability for applications, processes, circuits or assemblies, which are implemented using any Sawtek component described in this data sheet.

## Contact Information



PO Box 609501  
 Orlando, FL 32860-9501  
 USA

Phone: +1 (407) 886-8860  
 Fax: +1 (407) 886-7061  
 Email: [custservice@sawtek.com](mailto:custservice@sawtek.com)  
 Web: [www.sawtek.com](http://www.sawtek.com)

Or contact one of our worldwide  
 Network of [sales offices](#),  
[representatives or distributors](#)