

Preliminary Data Sheet

Features

- For cable headend IF applications
- Usable bandwidth 6.0 MHz
- High attenuation
- Single-ended operation
- Ceramic Surface Mount Package (SMP)
- Hermetic
- RoHS compliant (2002/95/EC), Pb-free 

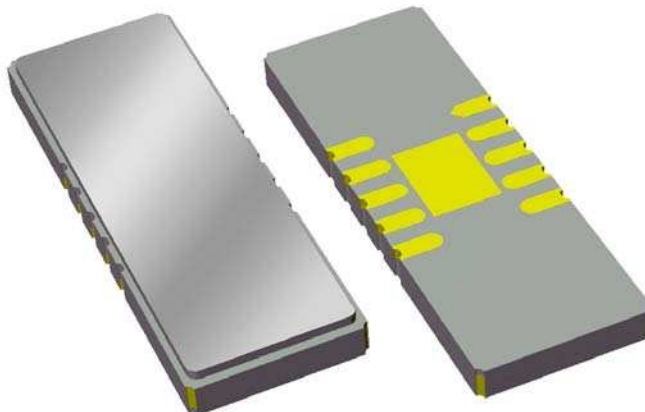

Package

Surface Mount 24.6 x 9.00 x 2.31 mm

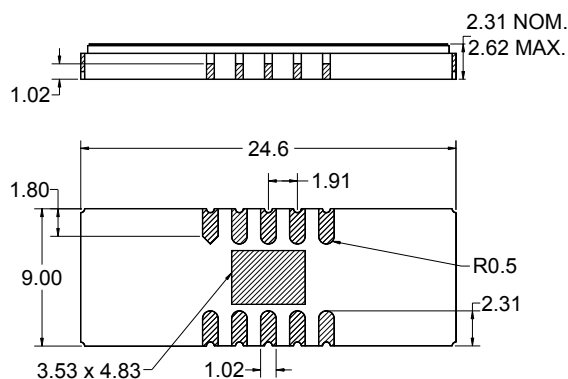

Pin Configuration

Bottom View

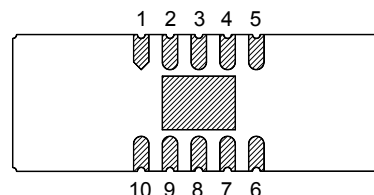

Pin No.	Description
1	Input return
5	Output
6	Output return
10	Input
2,3,4	Case Ground
7,8,9	Case Ground

Dimensions shown are nominal in millimeters
 All tolerances are ± 0.15 mm except overall
 length ± 0.20 mm and width $+0.13/-0.20$ mm

Body: Al_2O_3 ceramic
 Lid: Kovar, Ni plated
 Terminations: Au plating 0.5 - 1.0 μ m,
 over a 2 - 6 μ m Ni plating

Preliminary Data Sheet

Electrical Specifications ⁽¹⁾

Operating Temperature: ⁽²⁾ +25 °C

Parameter ⁽³⁾	Minimum	Typical	Maximum	Unit
Center Frequency	-	44.0	-	MHz
Minimum Insertion Loss	-	20.8	22.0	dB
Lower 3 dB Bandedge ⁽⁴⁾	-	40.95	41.0	MHz
Upper 3 dB Bandedge	47.0	47.07	-	MHz
Lower 38 dB Bandedge ⁽⁴⁾	40.0	40.35	-	MHz
Upper 38 dB Bandedge	-	47.75	48	MHz
Passband Variation 41.5 - 46.5 MHz	-	0.63	0.75	dB
Phase Linearity 41.9 - 46.1 MHz	-	3.35	4.25	deg
Group Delay Variation 41.9 - 46.1 MHz	-	80	100	μsec
Stopband Attenuation ⁽⁴⁾				
24 - 40 MHz	38	45	-	dB
48 - 84 MHz	38	45	-	dB
Source Impedance ⁽⁵⁾	-	50	-	Ω
Load Impedance ⁽⁵⁾	-	50	-	Ω

Notes:

1. All specifications are based on the test circuit shown below
2. This specification is valid for room temperature only
3. Electrical margin has been built into the design to account for the variations due to manufacturing tolerances
4. All attenuation measurements are measured relative to minimum insertion loss
5. This is the optimum impedance in order to achieve the performance shown

Test Circuit:

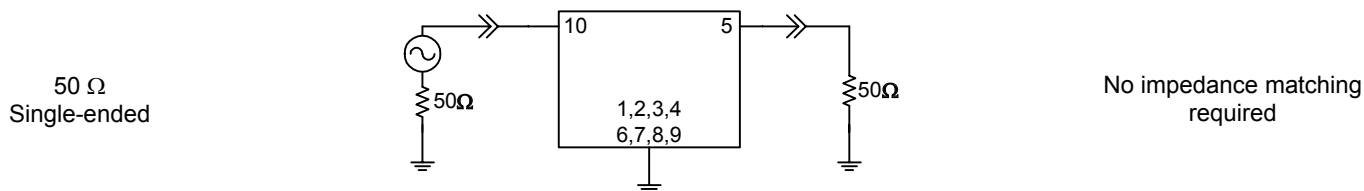

Preliminary Data Sheet

Typical Performance (at +25°C)

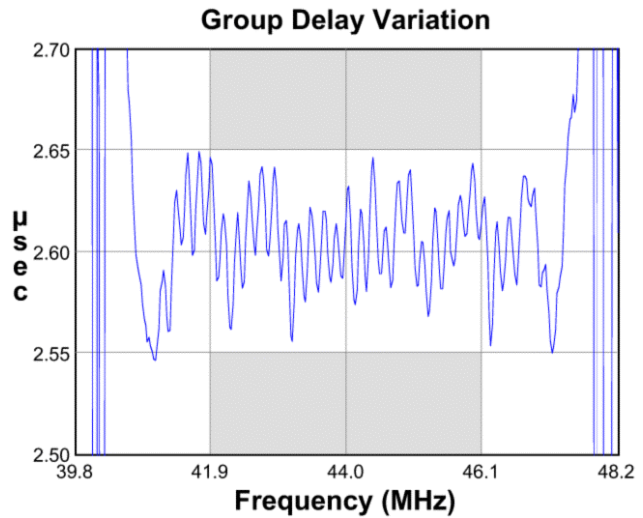
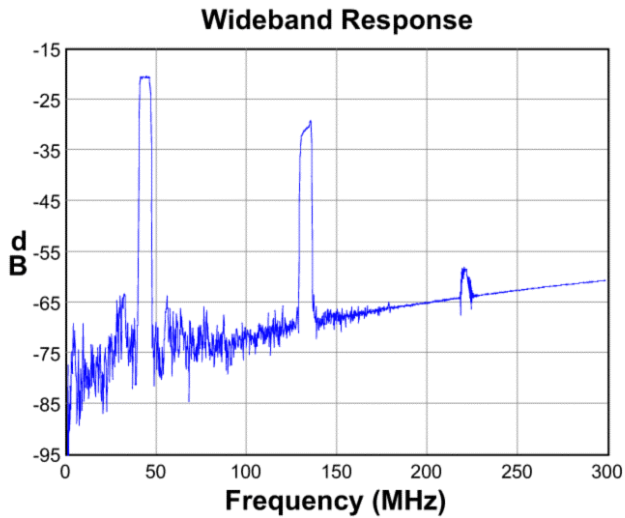
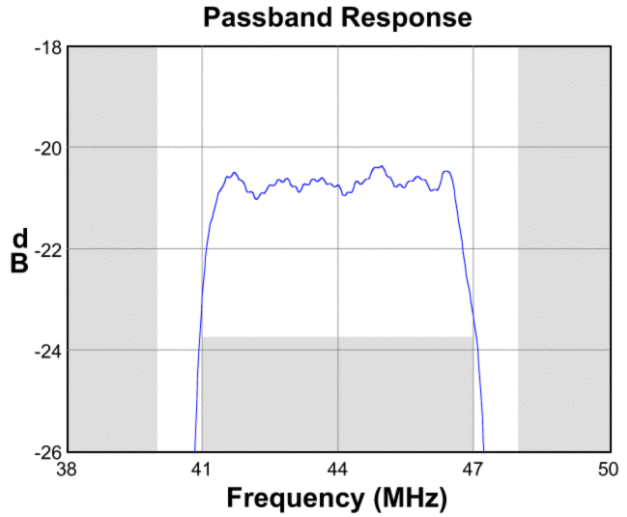
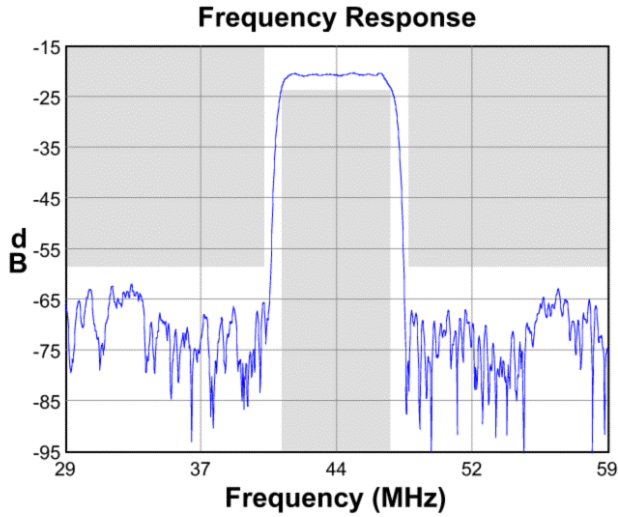

Input Smith Chart

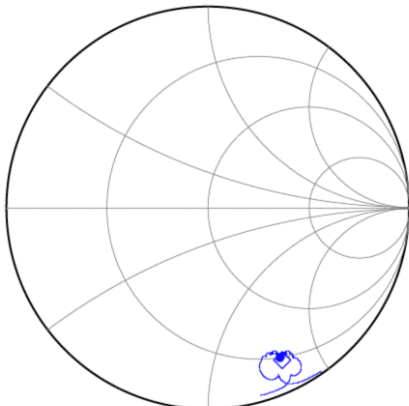

Output Smith Chart

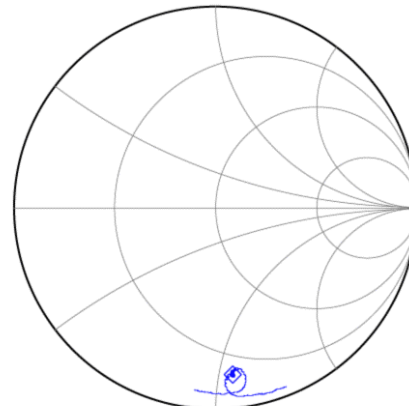

Preliminary Data Sheet

Matching Schematics

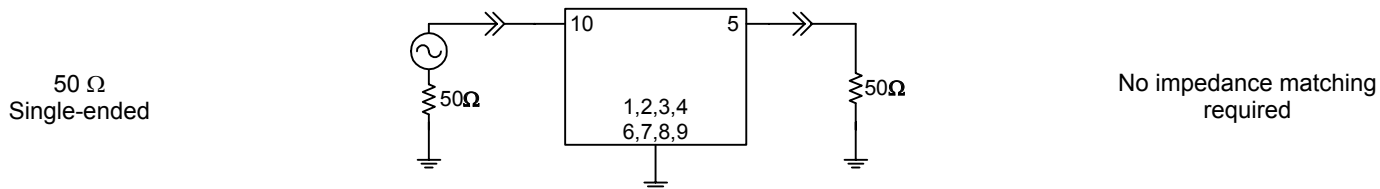

Marking

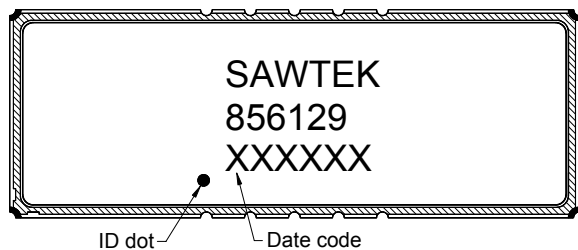

Date code is the day of the current year in Julian format, last digit of the year, and hour of the day

PCB Footprint

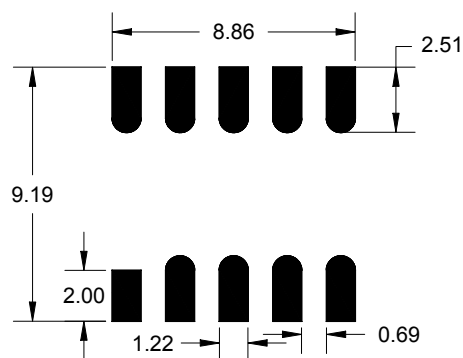

This footprint represents a recommendation only
Dimensions shown are nominal in millimeters

Tape and Reel

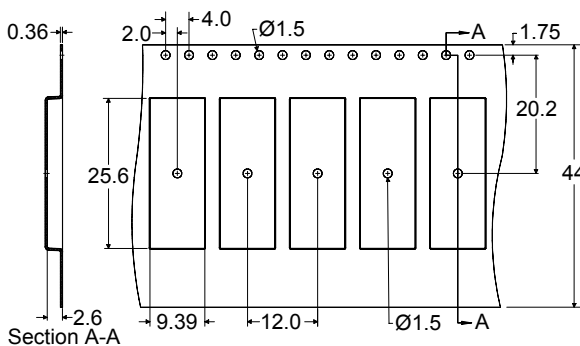
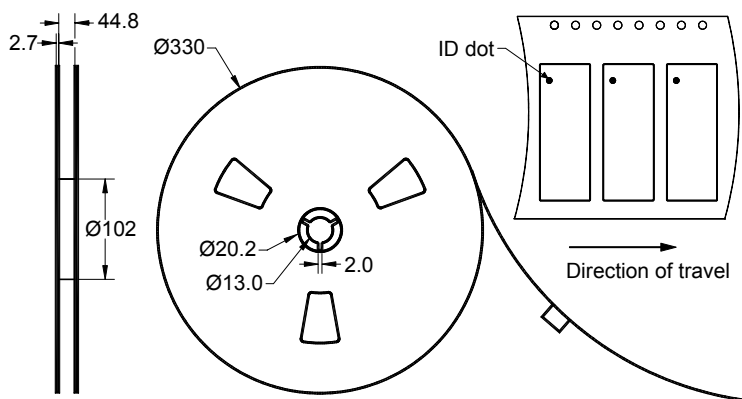

Dimensions shown are nominal in millimeters
Packaging quantity: 1000 units/reel

Preliminary Data Sheet

Maximum Ratings

Parameter	Symbol	Minimum	Typical	Maximum	Unit
Operating Temperature Range	T	-	25	-	°C
Storage Temperature Range	T _{stg}	-40	-	+85	°C

Important Notes

Warnings

- Electrostatic Sensitive Device (ESD) 
- Avoid ultrasonic exposure

RoHS Compliance

- This product complies with EU directive 2002/95/EC (RoHS) 

Solderability

- Compatible with JEDEC J-STD-020C **Pb**-free process, **260°C** peak reflow temperature ([see soldering profile](#))

Links to Additional Technical Information

[PCB Layout Tips](#)
[Qualification Flowchart](#)
[Soldering Profile](#)
[S-Parameters](#)
[RoHS Information](#)
[Other Technical Information](#)

Sawtek's liability is limited only to the Surface Acoustic Wave (SAW) component(s) described in this data sheet. Sawtek does not accept any liability for applications, processes, circuits or assemblies, which are implemented using any Sawtek component described in this data sheet.

Contact Information



PO Box 609501
Orlando, FL 32860-9501
USA

Phone: +1 (407) 886-8860
Fax: +1 (407) 886-7061
Email: custservice@sawtek.com
Web: www.sawtek.com

Or contact one of our worldwide
Network of [sales offices](#),
[representatives or distributors](#)