

# Data Sheet

## Features

- For Wireless LAN applications
- Usable bandwidth of 18 MHz
- High Attenuation
- Single-ended operation
- Ceramic Surface Mount Package (SMP)
- Hermetic
- RoHS compliant (2002/95/EC), Pb-free 

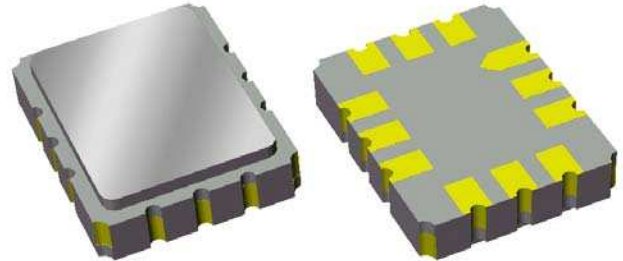

## Package

Surface Mount 7.01 x 5.51 x 1.63 mm

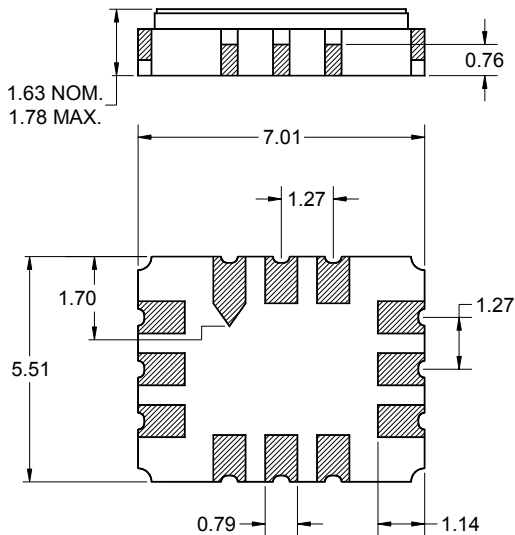

Dimensions shown are nominal in millimeters  
 All tolerances are  $\pm 0.15$ mm except overall  
 length and width  $\pm 0.13$ mm

Body:  $Al_2O_3$  ceramic  
 Lid: Kovar, Ni plated  
 Terminations: Au plating 0.5 - 1.0 $\mu$ m,  
 over a 2 - 6 $\mu$ m Ni plating

## Pin Configuration

Bottom View

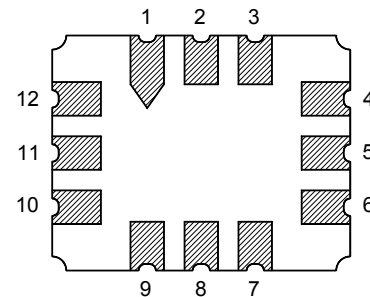

Pin No.	Description
4	Output
10	Input
1,2,3,5,6	Case Ground
7,8,9,11,12	Case Ground

# Data Sheet

## Electrical Specifications <sup>(1)</sup>

Operating Temperature Range: <sup>(2)</sup> -40 to +85 °C

Parameter <sup>(3)</sup>	Minimum	Typical	Maximum	Unit
Center Frequency <sup>(4)</sup>	969.20	970.060	970.80	MHz
Insertion Loss at f <sub>0</sub>	-	24.7	27	dB
Lower 3 dB Bandedge <sup>(5)</sup>	-	959.2	961	MHz
Upper 3 dB Bandedge	979	980.7	-	MHz
Lower 35 dB Bandedge <sup>(5)</sup>	954	955.9	-	MHz
Upper 35 dB Bandedge	-	984.3	986	MHz
Passband Ripple (over 3 dB bandwidth)	-	0.58	1.0	dB p-p
Passband Ripple (over any 300 kHz bandwidth)	-	0.15	0.3	dB p-p
Passband Amplitude Tilt	-	0.2	1.5	dB
Phase Ripple (over 3 dB bandwidth)	-	3	8.0	deg
Phase Ripple (over any 300 kHz bandwidth)	-	0.5	2.0	deg
Group Delay	-	0.5	0.6	µsec
Group Delay Variation (over 3 dB bandwidth)	-	25	100	nsec
Relative Attenuation <sup>(5)</sup>				
10 - 945 MHz	35	40	-	dB
995 - 1400 MHz	35	40	-	dB
Adjacent Channel Rejection (Integrated Power) <sup>(5)</sup>				
941.6 - 958.4 MHz	15	20	-	dB
981.6 - 998.4 MHz	15	20	-	dB
Source Impedance <sup>(6)</sup>	-	50	-	Ω
Load Impedance <sup>(6)</sup>	-	50	-	Ω

### Notes:

1. All specifications are based on the test circuit shown below
2. In production, devices will be tested at room temperature to a guardbanded specification to ensure electrical compliance over temperature
3. Electrical margin has been built into the design to account for the variations due to temperature drift and manufacturing tolerances
4. Evaluated as the mean of the 3dB frequencies relative to minimum insertion loss
5. Referenced to Minimum Insertion Loss
6. This is the optimum impedance in order to achieve the performance shown

### Test Circuit:

Actual matching values may vary due to PCB layout and parasitics

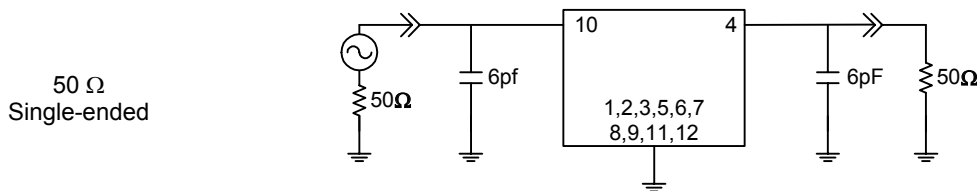

**Data Sheet**

**Typical Performance (at +25°C)**

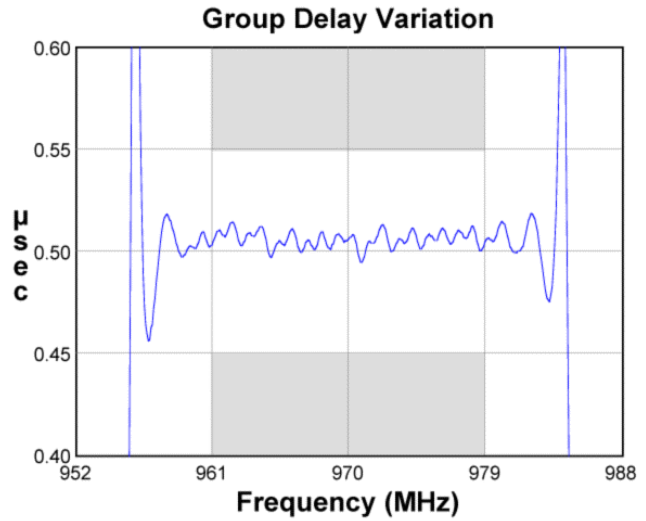
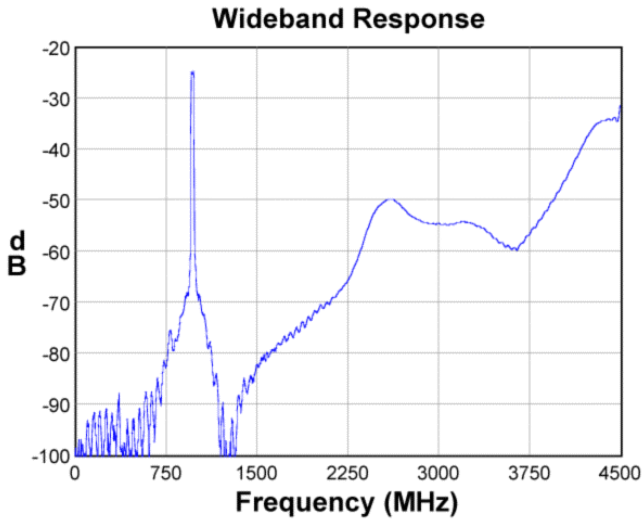
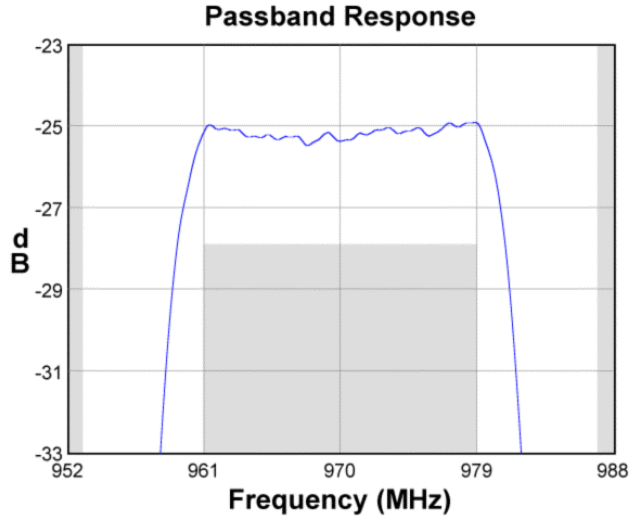
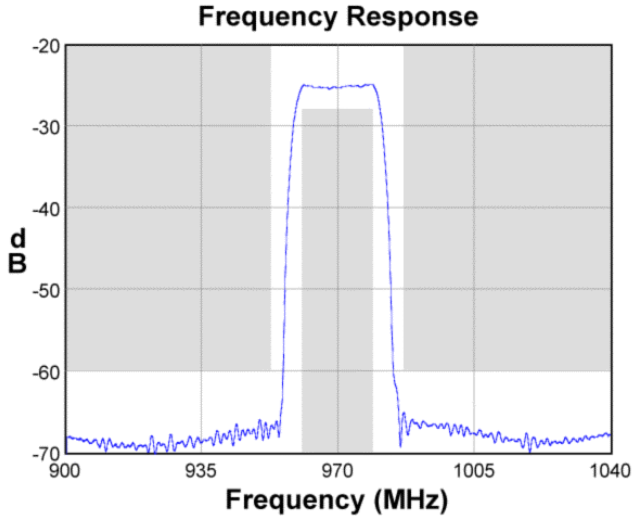

**Input Smith Chart**

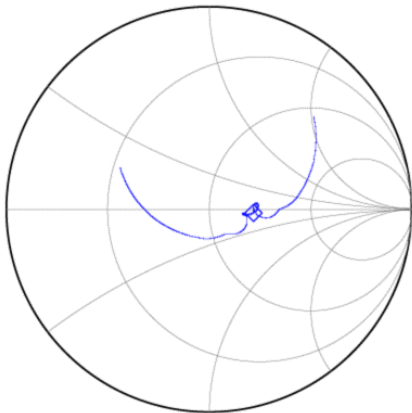

**Output Smith Chart**

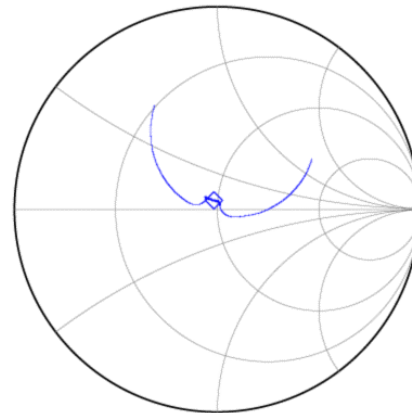

**Data Sheet**

**Matching Schematics**

Actual matching values may vary due to PCB layout and parasitics

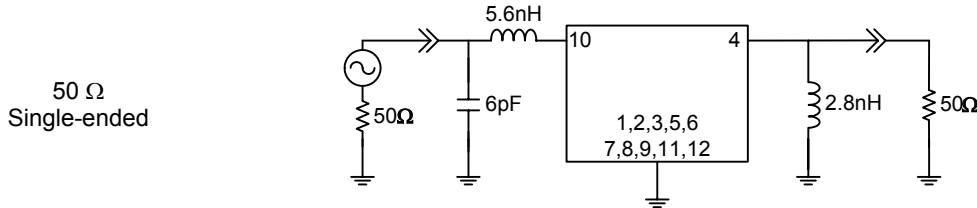

**Marking**

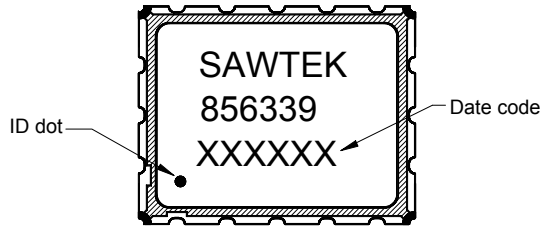

The date code consists of: day of the current year (Julian, 3 digits), last digit of the year (1 digit) and hour (2 digits)

**PCB Footprint**

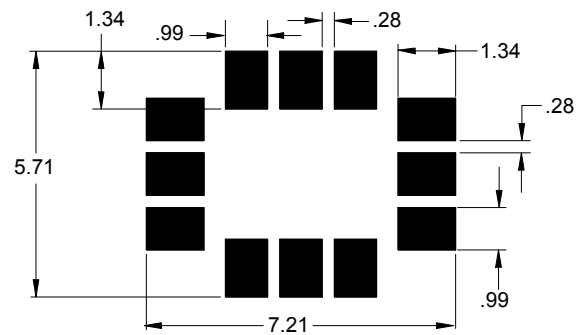

This footprint represents a recommendation only  
Dimensions shown are nominal in millimeters

**Tape and Reel**

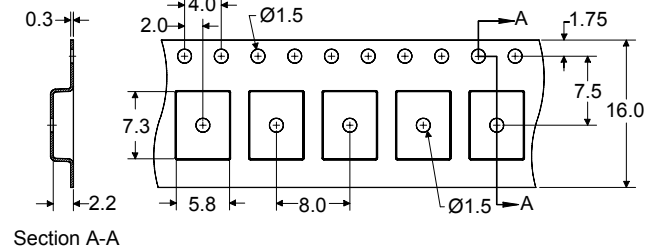
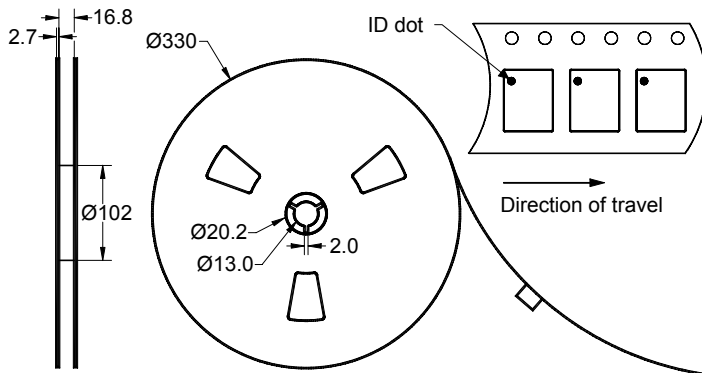

Dimensions shown are nominal in millimeters  
Packaging quantity: 3000 units/reel

# Data Sheet

## Maximum Ratings

Parameter	Symbol	Minimum	Maximum	Unit
Operating Temperature Range	T	-40	+85	°C
Storage Temperature Range	T <sub>stg</sub>	-55	+85	°C

## Important Notes

### Warnings

- Electrostatic Sensitive Device (ESD) 
- Avoid ultrasonic exposure

### RoHS Compliance

- This product complies with EU directive 2002/95/EC (RoHS) 

### Solderability

- Compatible with JEDEC J-STD-020C **Pb**-free process, **260°C** peak reflow temperature ([see soldering profile](#))

## Links to Additional Technical Information

[PCB Layout Tips](#)
[Qualification Flowchart](#)
[Soldering Profile](#)
[S-Parameters](#)
[RoHS information](#)
[Other Technical Information](#)

Sawtek's liability is limited only to the Surface Acoustic Wave (SAW) component(s) described in this data sheet. Sawtek does not accept any liability for applications, processes, circuits or assemblies, which are implemented using any Sawtek component described in this data sheet.

## Contact Information



PO Box 609501  
Orlando, FL 32860-9501  
USA

Phone: +1 (407) 886-8860  
Fax: +1 (407) 886-7061  
Email: [custservice@sawtek.com](mailto:custservice@sawtek.com)  
Web: [www.sawtek.com](http://www.sawtek.com)

Or contact one of our worldwide  
Network of [sales offices](#),  
[representatives or distributors](#)