

Features

- For GPS applications
- Usable bandwidth of 20 MHz
- Typical 3 dB bandwidth of 35 MHz
- Low loss
- High attenuation
- Single-ended operation
- No impedance matching required for operation at 50Ω
- Chip Scale Package (CSP)
- Hermetic
- **RoHS** compliant (2002/95/EC), **Pb-free** 

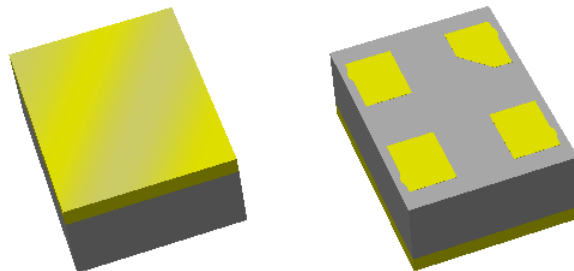

Package

Surface Mount 2.00 x 1.50 x 0.76 mm

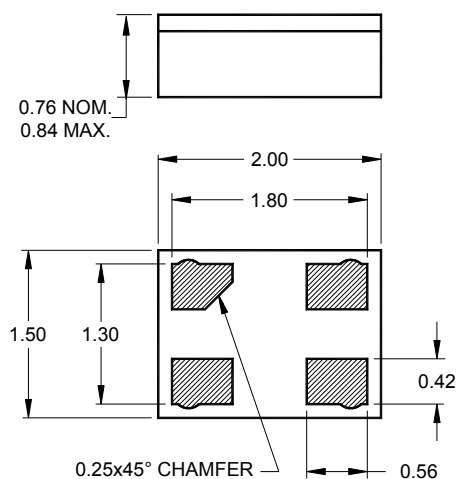

Dimensions shown are nominal in millimeters
All tolerances are ±0.10mm

Body: Al_2O_3 ceramic
Lid: Kovar or Alloy 42, Au over Ni plated
Terminations: Au plating 0.5 - 1.0μm,
over a 2 - 6μm Ni plating

Pin Configuration

Bottom View

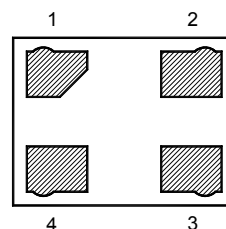

Pin No.	Description
1	Input
3	Output
2,4	Case ground

Electrical Specifications ⁽¹⁾

Operating Temperature Range: ⁽²⁾ -40 to +85 °C

Parameter ⁽³⁾	Minimum	Typical	Maximum	Unit
Center Frequency	-	1176	-	MHz
Maximum Insertion Loss 1166 - 1186 MHz	-	2.4	3.0	dB
Amplitude Ripple 1166 - 1186 MHz	-	0.21	1	dB p-p
Absolute Attenuation 10 - 1036 MHz	35	44	-	dB
1036 - 1126 MHz	20	33	-	dB
1226 - 1316 MHz	20	33	-	dB
1316 - 1500 MHz	35	40	-	dB
1500 - 3000 MHz	30	35	-	dB
Group Delay Variation 1166 - 1186 MHz	-	10	50	ns
Input/Output Return Loss 1166 - 1186 MHz	10	14	-	dB
Input Power	-	-	10	dBm
Source Impedance: ⁽⁴⁾	-	50	-	Ω
Load Impedance: ⁽⁴⁾	-	50	-	Ω

Notes:

1. All specifications are based on the test circuit shown below
2. In production, devices will be tested at room temperature to a guardbanded specification to ensure electrical compliance over temperature
3. Electrical margin has been built into the design to account for the variations due to temperature drift and manufacturing tolerances
4. This is the optimum impedance in order to achieve the performance shown

Test Circuit:

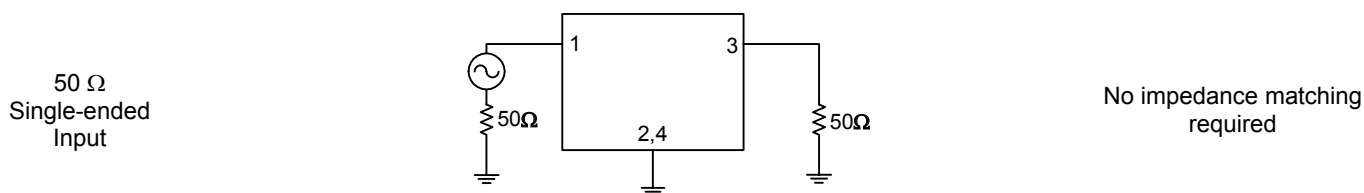

Typical Performance (at +25°C)

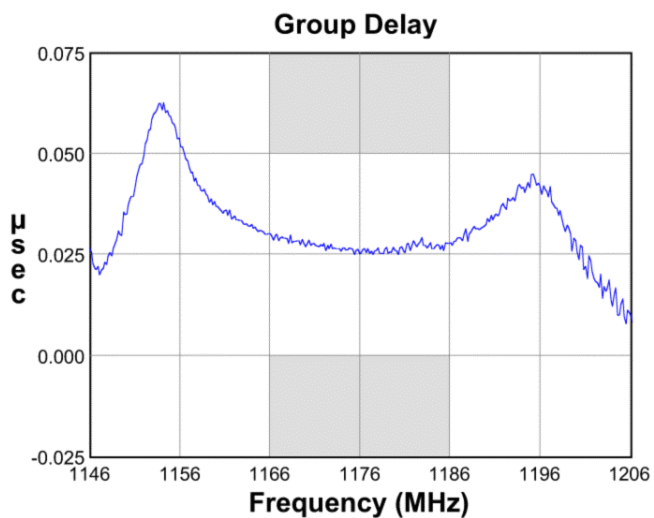
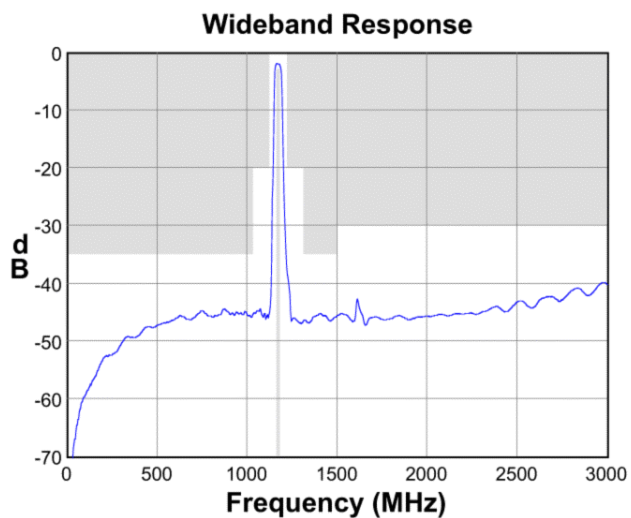
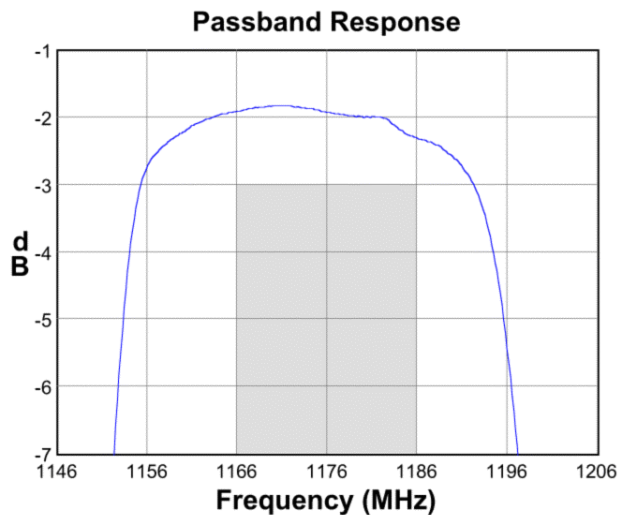
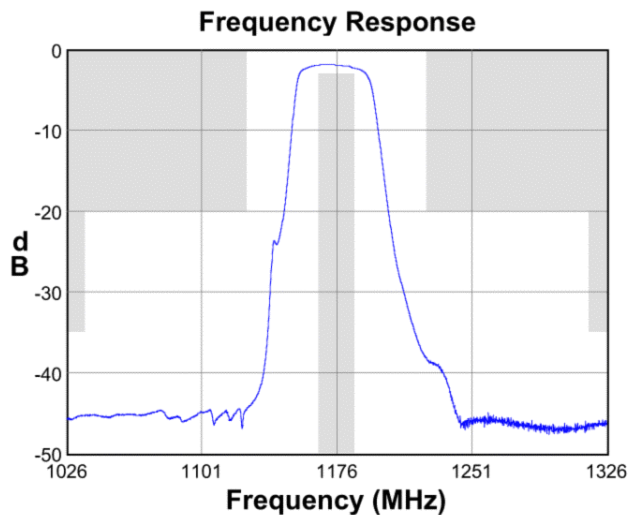

Input Smith Chart

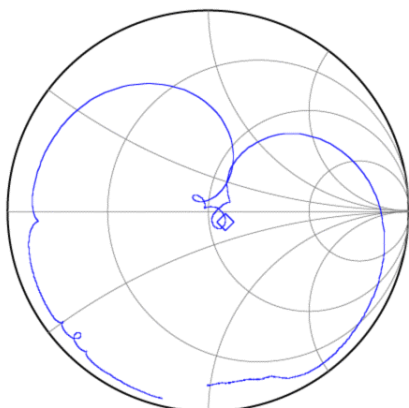

Output Smith Chart

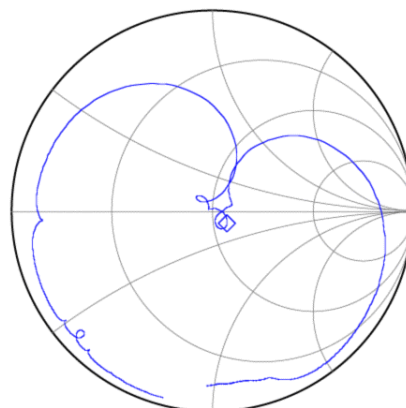

Matching Schematics

50 Ω
Single-ended

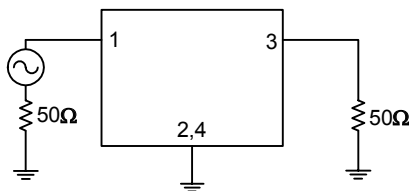

No impedance matching required

Marking

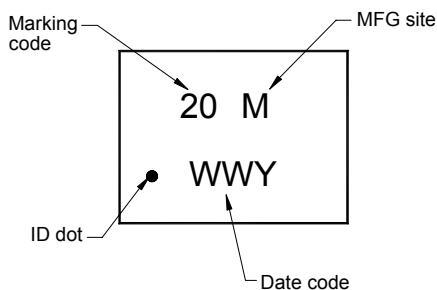

The date code consists of: WW = 2 digit week,
Y = last digit of year, M = manufacturing site code

PCB Footprint

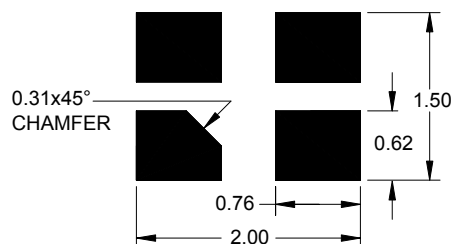

This footprint represents a recommendation only
Dimensions shown are nominal in millimeters

Tape and Reel

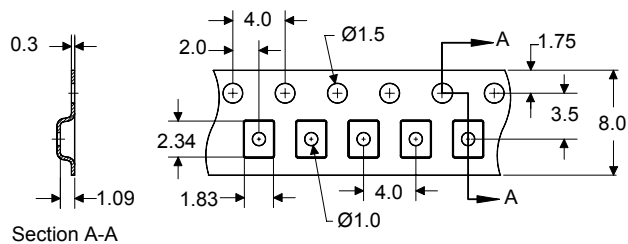
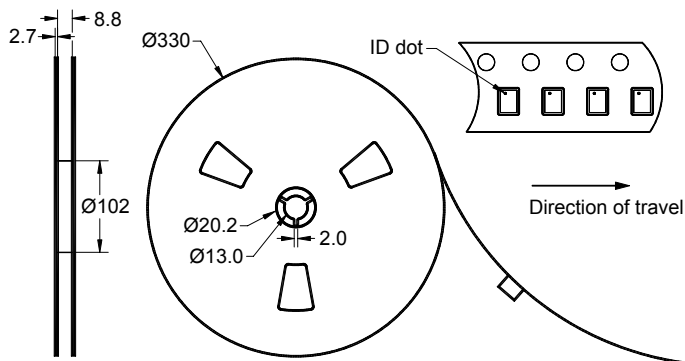

Dimensions shown are nominal in millimeters
Packaging quantity: 10000 units/reel

Data Sheet

Maximum Ratings

Parameter	Symbol	Minimum	Maximum	Unit
Operating Temperature Range	T	-40	+85	°C
Storage Temperature Range	T _{stg}	-40	+85	°C

Warnings

- Electrostatic Sensitive Device (ESD) 
- Avoid ultrasonic exposure

Material Content

- Does not contain lead (Pb) or other RoHS restricted materials

Links to Additional Technical Information

[PCB Layout Tips](#)

[Qualification Flowchart](#)

[Soldering Profile](#)

[S-Parameters](#)

[RoHS Information](#)

[Other Technical Information](#)

TriQuint's liability is limited only to the Surface Acoustic Wave (SAW) component(s) described in this data sheet. TriQuint does not accept any liability for applications, processes, circuits or assemblies which are implemented using any TriQuint component described in this data sheet.

Contact Information

TriQuint 
SEMICONDUCTOR

PO Box 609501
Orlando, FL 32860-9501
USA

Phone: +1 (407) 886-8860
Fax: +1 (407) 886-7061
Email: info-product@tqs.com
Web: www.triquint.com

Or contact one of our worldwide
Network of [sales offices](#),
[Representatives or distributors](#)