

Preliminary Data Sheet

Features

- For GSM/EDGE applications
- Usable bandwidth 400 MHz
- High attenuation
- Single-ended and differential operation
- Ceramic Surface Mount Package (SMP)
- Hermetic
- **RoHS** compliant (2002/95/EC), **Pb-free** 

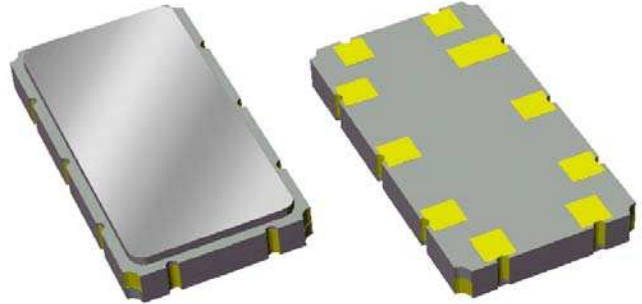

Package

Surface Mount 9.10 x 4.80 x 1.24 mm

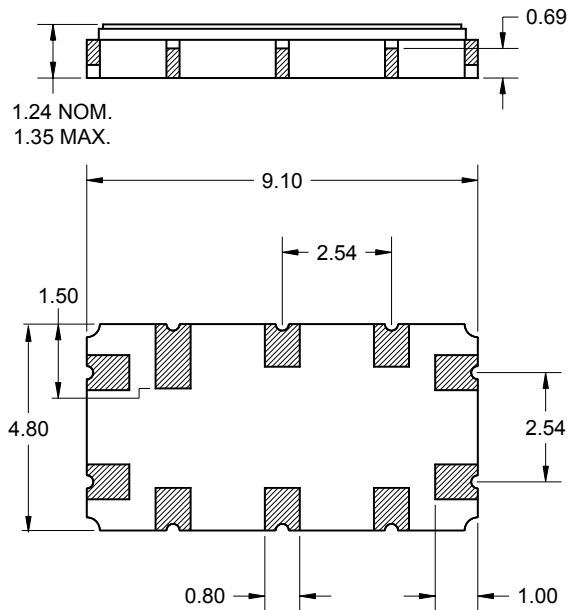

Dimensions shown are nominal in millimeters
All tolerances are ± 0.15 mm except overall
length and width $+0.10$ mm/ -0.10 mm

Body: Al_2O_3 ceramic
Lid: Kovar, Ni plated
Terminations: Au plating 0.5 - 1.0 μ m,
over a 2 - 6 μ m Ni plating

Pin Configuration

Bottom View

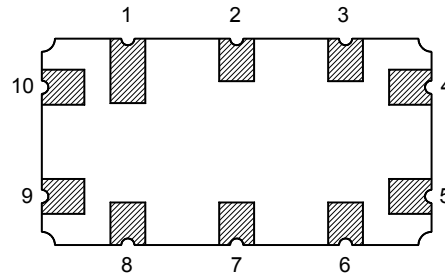

Pin No.	Description
5	Output
4	Output Return
10	Input
9	Input Return
1,2,3,6,7,8	Case Ground

Preliminary Data Sheet

Electrical Specifications ⁽¹⁾

Operating Temperature Range: ⁽²⁾ -10 to +85 °C

Parameter ⁽³⁾	Minimum	Typical	Maximum	Unit
Center Frequency	-	208	-	MHz
Insertion Loss at Fo	4	5.88	7	dB
1 dB Lower Frequency	-	207.63	207.8	MHz
1 dB Upper Frequency	208.2	208.32	-	MHz
8 dB Lower Frequency	207.4	207.45	-	MHz
8 dB Upper Frequency	-	208.50	208.6	MHz
20 dB Lower Frequency	206.8	207.01	-	MHz
20 dB Upper Frequency	-	208.95	209.2	MHz
Amplitude Variation 207.8 - 208.2 MHz	-	0.32	1	dB p-p
Group Delay Variation 207.8 - 208.2 MHz	-	135	300	nsec
Absolute Delay 207.8 - 208.2 MHz	0.775	0.875	0.975	µsec
Absolute Attenuation 10 - 195 MHz	55	62	-	dB
195.0 - 198.5 MHz	43	60	-	dB
198.5 - 202.0 MHz	40	53	-	dB
202.0 - 204.6 MHz	34	45	-	dB
204.6 - 206.2 MHz	25	37	-	dB
206.2 - 206.8 MHz	20	36	-	dB
209.2 - 209.8 MHz	20	36	-	dB
209.8 - 211.4 MHz	25	37	-	dB
211.4 - 214.0 MHz	34	43	-	dB
214.0 - 217.5 MHz	40	53	-	dB
217.5 - 221.0 MHz	43	58	-	dB
221.0 - 450.0 MHz	55	58	-	dB
Input/Output VSWR 207.8 - 208.2 MHz	-	1.53	2.3	-
Source Impedance ⁽⁴⁾	-	50	-	Ω
Load Impedance ⁽⁴⁾	-	50	-	Ω

Notes:

1. All specifications are based on the test circuit on page 4
2. In production, devices will be tested at room temperature to a guardbanded specification to ensure electrical compliance over temperature
3. Electrical margin has been built into the design to account for the variations due to temperature drift and manufacturing tolerances
4. This is the optimum impedance in order to achieve the performance shown

Preliminary Data Sheet

Typical Performance (at +25°C)

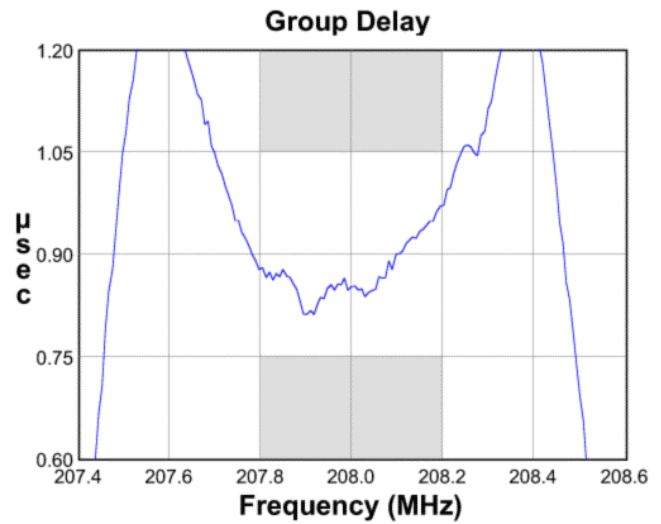
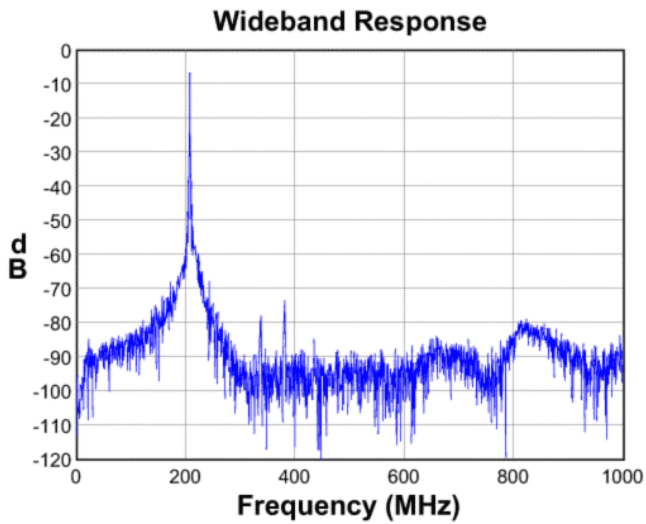
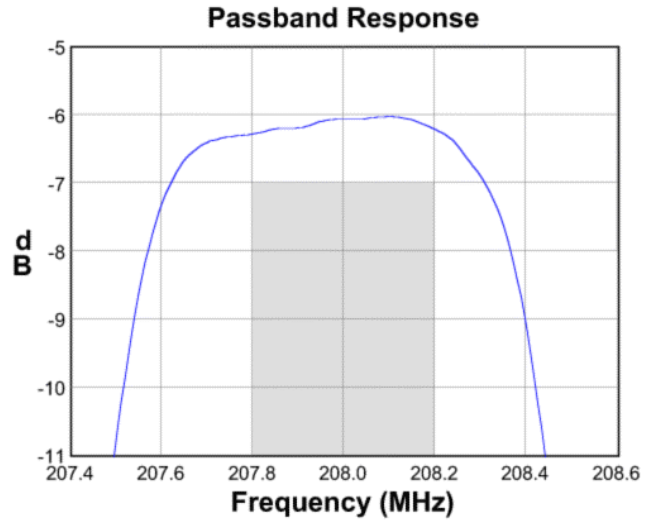
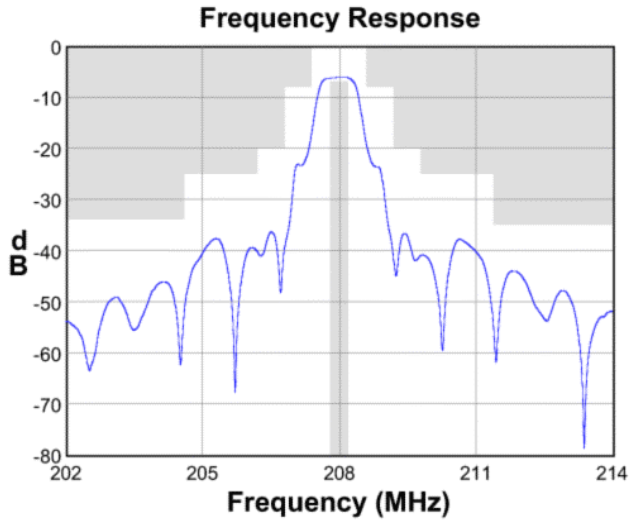

Input Smith Chart

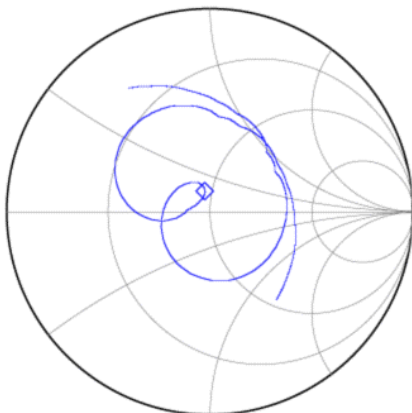

Output Smith Chart

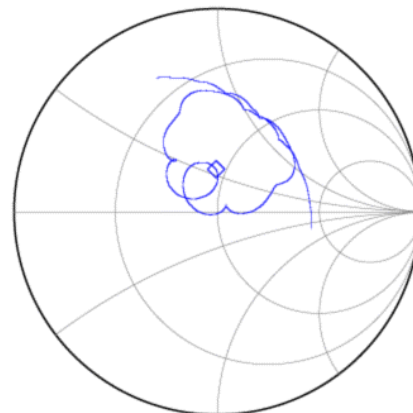

Preliminary Data Sheet

Matching Schematics

Actual matching values may vary due to PCB layout and parasitics

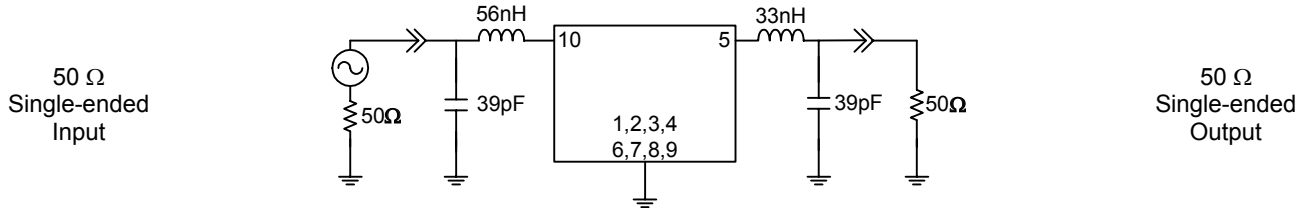

Marking

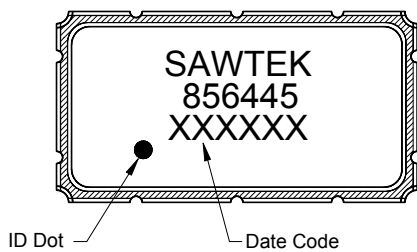

The date code consists of: day of the current year (Julian, 3 digits), last digit of the year (1 digit) and hour (2 digits)

PCB Footprint

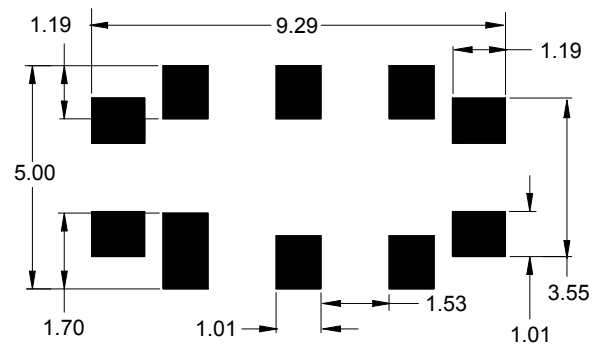

This footprint represents a recommendation only
Dimensions shown are nominal in millimeters

Tape and Reel

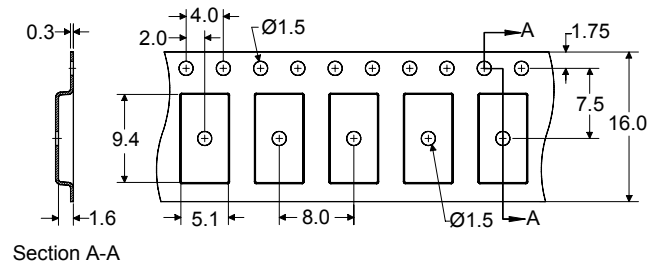
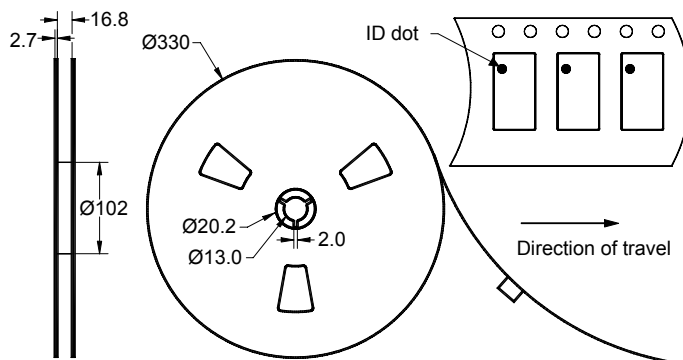

Dimensions shown are nominal in millimeters
Packaging quantity: 4000 units/reel

Preliminary Data Sheet

Maximum Ratings

Parameter	Symbol	Minimum	Maximum	Unit
Operating Temperature Range	T	-10	+85	°C
Storage Temperature Range	T _{stg}	-40	+85	°C
Input Power	P _{in}	-	10	dBm

Important Notes

Warnings

- Electrostatic Sensitive Device (ESD) 
- Avoid ultrasonic exposure

RoHS Compliance

- This product complies with EU directive 2002/95/EC (RoHS) 

Solderability

- Compatible with JEDEC J-STD-020C **Pb**-free process, **260°C** peak reflow temperature ([see soldering profile](#))

Links to Additional Technical Information

[PCB Layout Tips](#)

[Qualification Flowchart](#)

[Soldering Profile](#)

[S-Parameters](#)

[RoHS information](#)

[Other Technical Information](#)

Sawtek's liability is limited only to the Surface Acoustic Wave (SAW) component(s) described in this data sheet. Sawtek does not accept any liability for applications, processes, circuits or assemblies, which are implemented using any Sawtek component described in this data sheet.

Contact Information



PO Box 609501
 Orlando, FL 32860-9501
 USA

Phone: +1 (407) 886-8860
 Fax: +1 (407) 886-7061
 Email: custservice@sawtek.com
 Web: www.sawtek.com

Or contact one of our worldwide
 Network of [sales offices](#),
[representatives or distributors](#)