

Preliminary Data Sheet

Features

- For AMPS, CDMA and TDMA repeater and booster applications
- Usable bandwidth 25 MHz
- High attenuation
- No impedance matching required for operation at 50 Ω
- Single-ended operation
- Ceramic Surface Mount Package (SMP)
- Hermetic
- RoHS compliant (2002/95/EC), Pb-free 

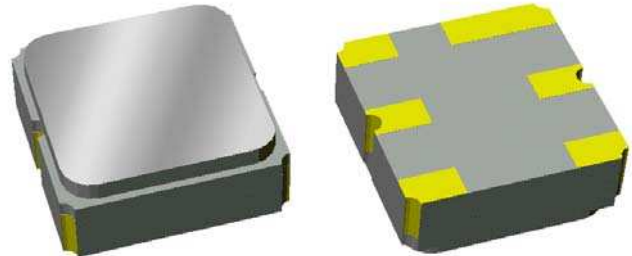

Package

Surface Mount 3.00 x 3.00 x 1.22 mm

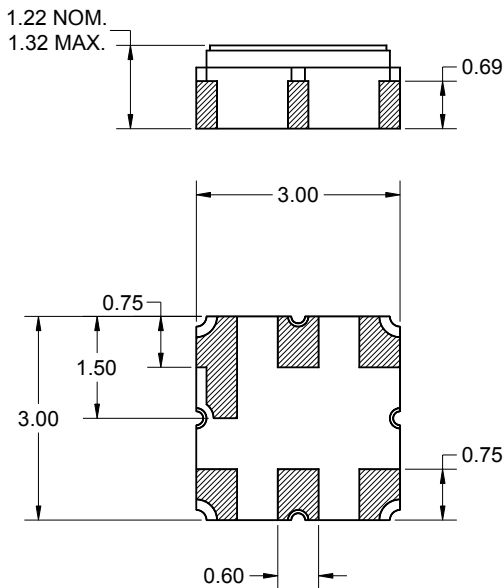

Pin Configuration

Bottom View

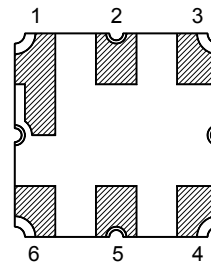

Pin No.	Description
2,5	Input/Output
1,3,4,6	Case ground

Dimensions shown are nominal in millimeters
All tolerances are $\pm 0.15\text{mm}$ except overall
length and width $\pm 0.10\text{mm}$

Body: Al_2O_3 ceramic
Lid: Kovar, Ni plated
Terminations: Au plating 0.5 - 1.0 μm ,
over a 2 - 6 μm Ni plating

Preliminary Data Sheet

Electrical Specifications ⁽¹⁾

Operating Temperature Range: ⁽²⁾ -30 to +85 °C

Parameter ⁽³⁾	Minimum	Typical	Maximum	Unit
Center Frequency	-	836.5	-	MHz
Maximum Insertion Loss 824 - 849 MHz	-	2.7	3.5	dB
Amplitude Variation 824 - 849 MHz	-	0.85	1.5	dB p-p
Absolute Attenuation DC - 800 MHz	40	50	-	dB
859 - 869 MHz (at +25 °C only)	13	18	-	dB
869 - 925 MHz	28	33	-	dB
925 - 2000 MHz	40	45	-	dB
Input/Output Return Loss 824 - 849 MHz	9.5	13.6	-	dB
Source Impedance: ⁽⁴⁾	-	50	-	Ω
Load Impedance: ⁽⁴⁾	-	50	-	Ω

Notes:

1. All specifications are based on the test circuit shown below
2. In production, devices will be tested at room temperature to a guardbanded specification to ensure electrical compliance over temperature
3. Electrical margin has been built into the design to account for the variations due to temperature drift and manufacturing tolerances
4. This is the optimum impedance in order to achieve the performance shown

Test Circuit:

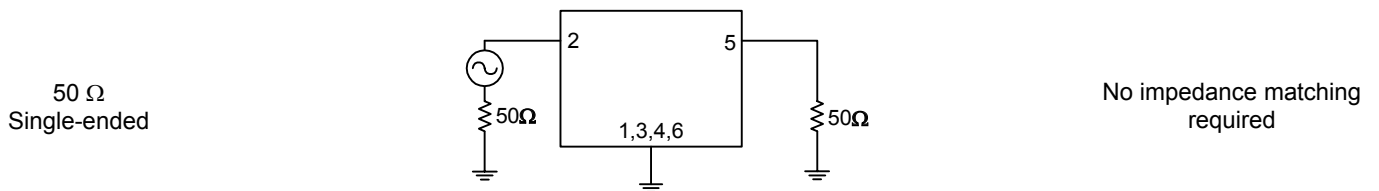

Preliminary Data Sheet

Typical Performance (at +25°C)

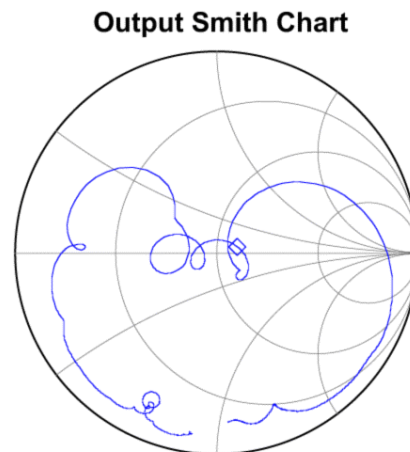
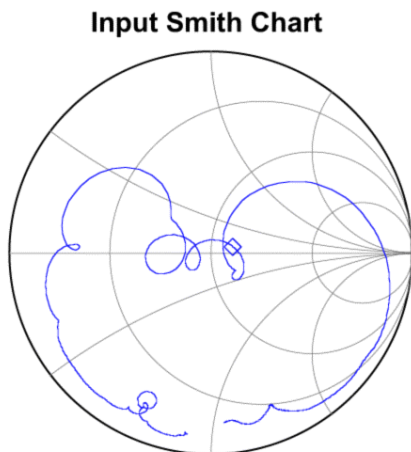
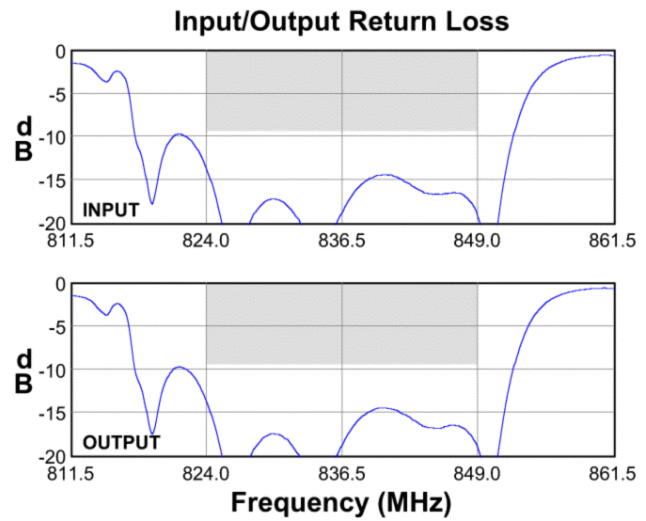
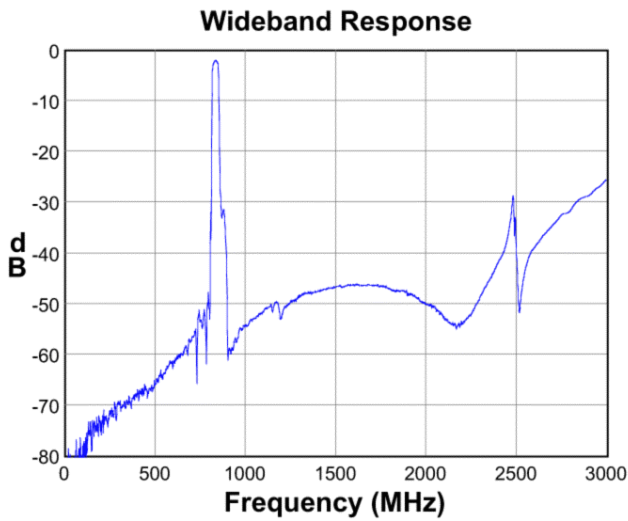
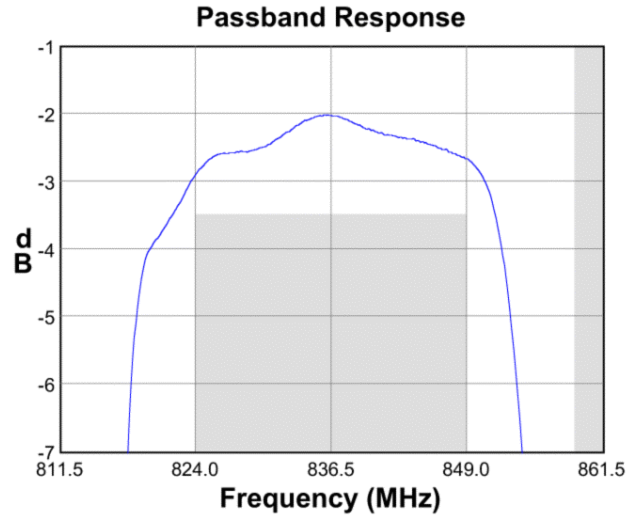
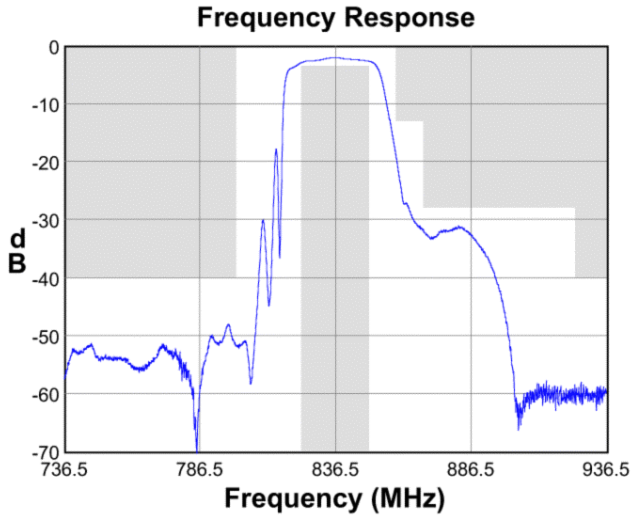

Preliminary Data Sheet

Matching Schematics

50 Ω
Single-ended

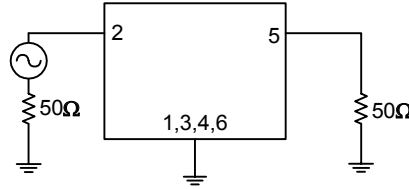

No impedance matching required

Marking PCB Footprint

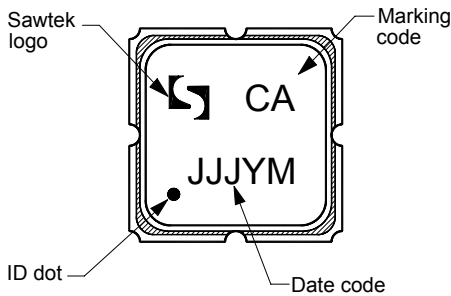

The date code consists of: JJJ = Julian day,
Y = last digit of year, M = manufacturing site code

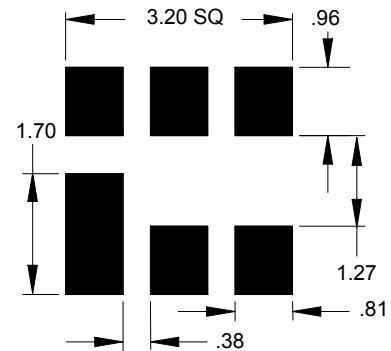

This footprint represents a recommendation only
Dimensions shown are nominal in millimeters

Tape and Reel

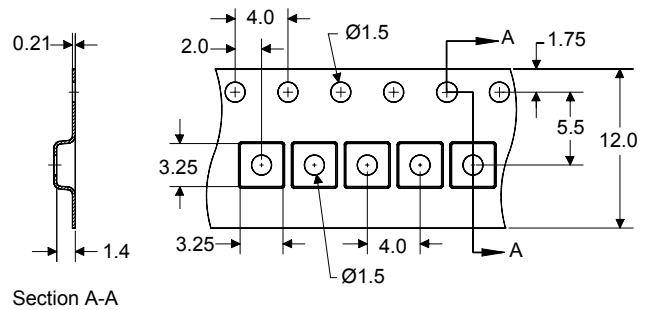
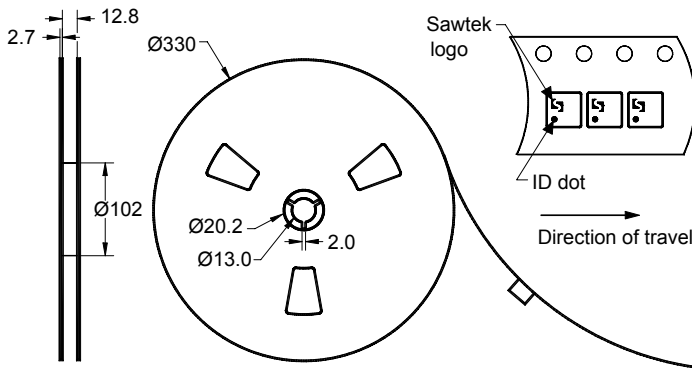

Dimensions shown are nominal in millimeters
Packaging quantity: 5000 units/reel

Preliminary Data Sheet

Maximum Ratings

Parameter	Symbol	Minimum	Maximum	Unit
Operating Temperature Range	T	-30	+85	°C
Storage Temperature Range	T _{stg}	-40	+85	°C
RF Power	P _{in}	-	+10	dBm

Important Notes

Warnings

- Electrostatic Sensitive Device (ESD) 
- Avoid ultrasonic exposure

RoHS Compliance

- This product complies with EU directive 2002/95/EC (RoHS) 

Solderability

- Compatible with JEDEC J-STD-020C **Pb**-free process, **260°C** peak reflow temperature ([see soldering profile](#))

Links to Additional Technical Information

[PCB Layout Tips](#)

[Qualification Flowchart](#)

[Soldering Profile](#)

[S-Parameters](#)

[RoHS information](#)

[Other Technical Information](#)

Sawtek's liability is limited only to the Surface Acoustic Wave (SAW) component(s) described in this data sheet. Sawtek does not accept any liability for applications, processes, circuits or assemblies, which are implemented using any Sawtek component described in this data sheet.

Contact Information



PO Box 609501
 Orlando, FL 32860-9501
 USA

Phone: +1 (407) 886-8860
 Fax: +1 (407) 886-7061
 Email: custservice@sawtek.com
 Web: www.sawtek.com

Or contact one of our worldwide
 Network of [sales offices](#),
[representatives or distributors](#)