

Features

- For Base Station applications
- Usable bandwidth 60 MHz
- Low Loss
- Single-ended operation
- Ceramic Surface Mount Package (SMP)
- Hermetic
- **RoHS** compliant (2002/95/EC), **Pb-free** 

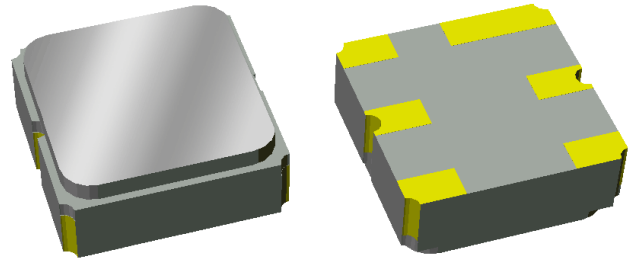

Package

Surface Mount 3.00 x 3.00 x 1.22 mm
 SMP-12

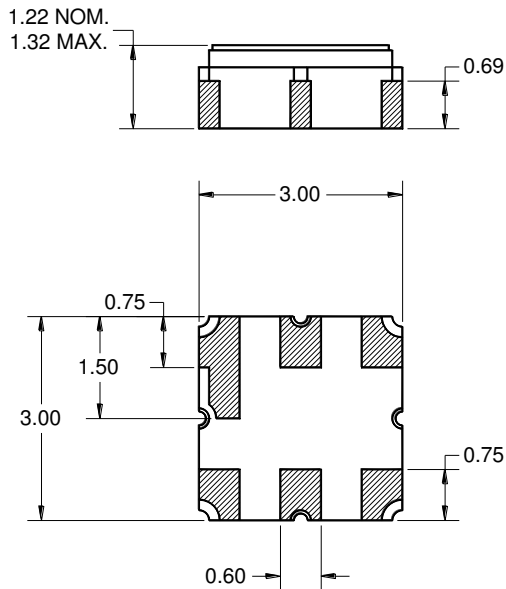

Dimensions shown are nominal in millimeters
 All tolerances are ± 0.15 mm except overall
 length and width ± 0.10 mm

Body: Al_2O_3 ceramic
 Lid: Kovar, Ni plated
 Terminations: Au plating 0.5 - 1.0 μ m,
 over a 2 - 6 μ m Ni plating

Pin Configuration

Bottom View

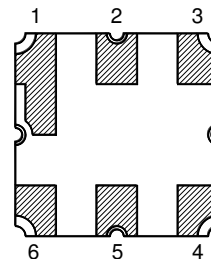

Pin No.	Description
2	Input
5	Output
1,3,4,6	Case ground

Electrical Specifications ⁽¹⁾

Operating Temperature Range: ⁽²⁾ -30 to +85 °C

Parameter ⁽³⁾	Minimum	Typical ⁽⁴⁾	Maximum	Unit
Center Frequency	-	1880	-	MHz
Maximum Insertion Loss 1850 – 1910 MHz	-	2.3	3.0	dB
Amplitude Variation 1850 – 1910 MHz	-	0.5	1.2	dB p-p
Amplitude Variation over any 5MHz window 1850 – 1910 MHz	-	0.2	0.8	dB p-p
Absolute Group Delay 1850 – 1910 MHz	-	10.0	30	ns
Group Delay Variation 1850 – 1910 MHz	-	7.7	25	ns p-p
Phase Ripple 1850 – 1910 MHz	-	12.0	30	° p-p
Relative Attenuation ⁽⁵⁾				
50 – 110 MHz	35	55.5	-	dB
300 – 400 MHz	35	45.0	-	dB
920 – 965 MHz	35	41.0	-	dB
965 – 1300 MHz	25	40.5	-	dB
1300 – 1635 MHz	25	37.0	-	dB
1635 – 1665 MHz	25	37.7	-	dB
1665 – 1730 MHz	25	34.7	-	dB
1730 – 1790 MHz	10	19.7	-	dB
2030 – 2090 MHz	20	25.2	-	dB
2573 – 2621 MHz	30	34.2	-	dB
4074 – 4162 MHz	20	31.0	-	dB
4791 – 4879 MHz	18	23.0	-	dB
Input/Output VSWR 1850 – 1910 MHz	-	1.75	2:1	-
Source Impedance (single-ended) ⁽⁶⁾	-	50	-	Ω
Load Impedance (single-ended) ⁽⁶⁾	-	50	-	Ω

Notes:

1. All specifications are based on TriQuint test circuit shown on page 4
2. In production, devices will be tested at room temperature to a guardbanded specification to ensure electrical compliance over temperature
3. Electrical margin has been built into the design to account for the variations due to temperature drift and manufacturing tolerances
4. Typical values are based on average measurements on pcb at room temperature, unless otherwise noted
5. Relative to Maximum Insertion loss in passband
6. This is the optimum impedance in order to achieve the performance shown

Typical Performance (at +25°C)

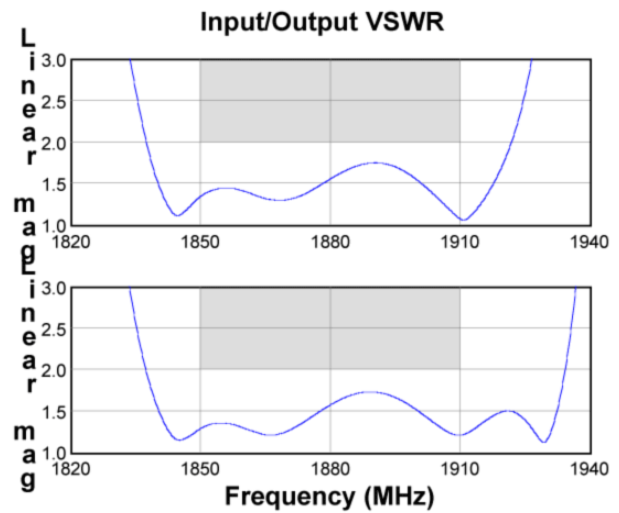
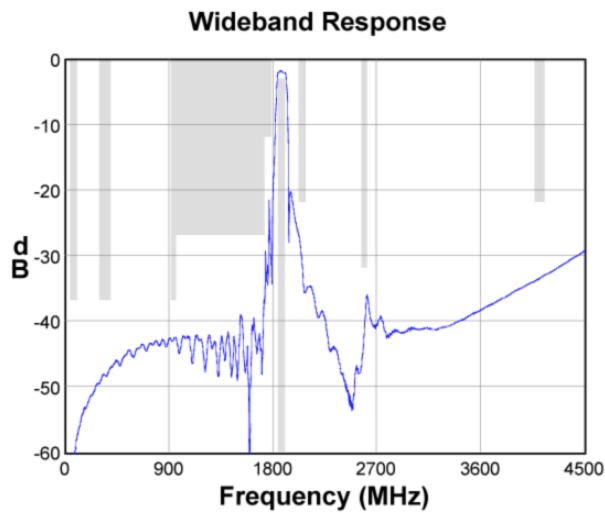
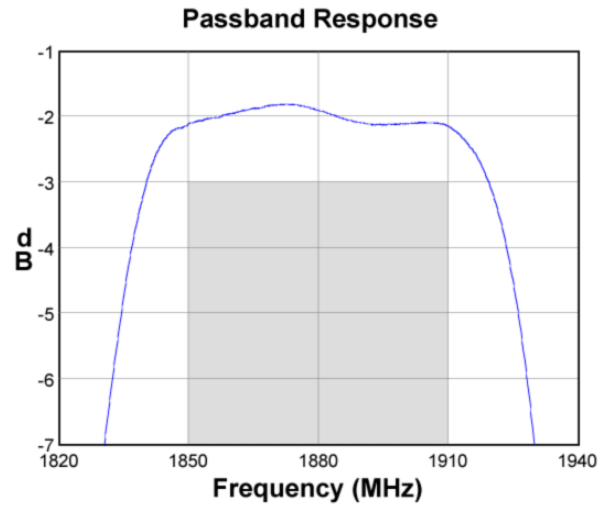
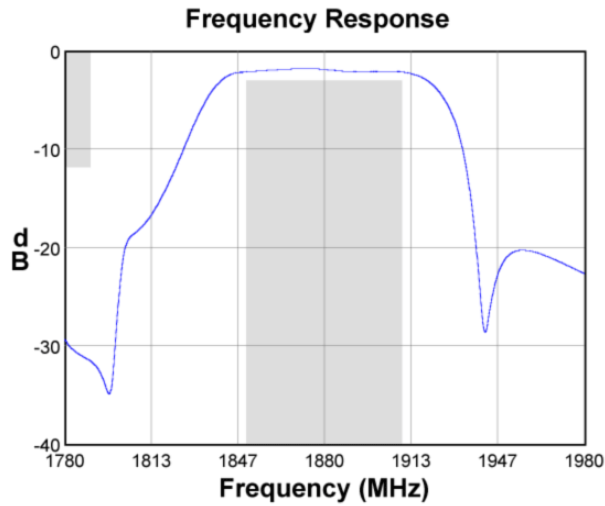

Input Smith Chart

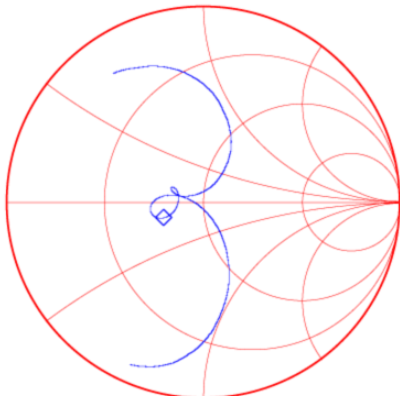

Output Smith Chart

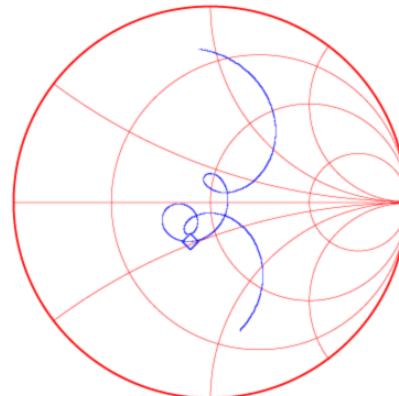

Matching Schematics

Actual matching network values to be determined

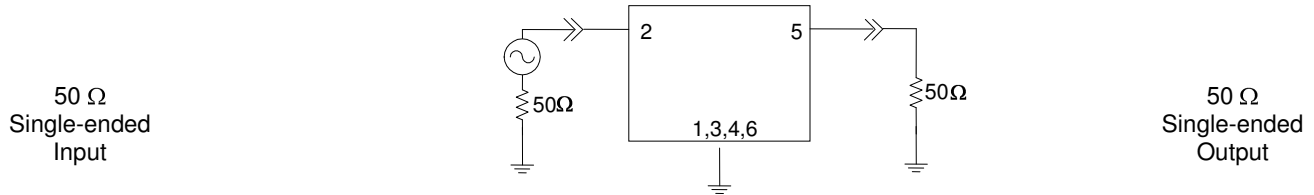

Marking

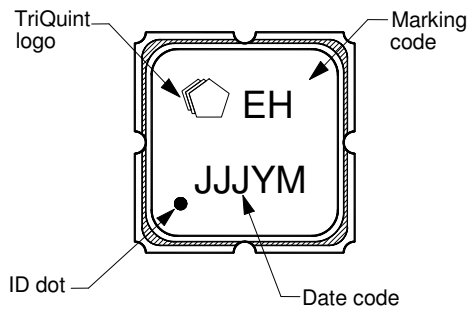

The date code consists of: JJJ = Julian day, Y = last digit of year, M = manufacturing site code

PCB Footprint

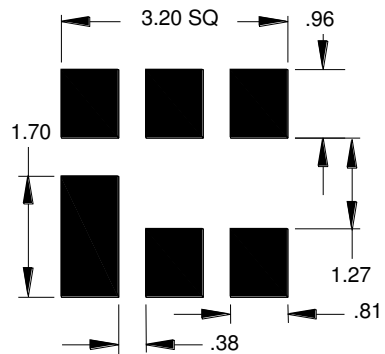

This footprint represents a recommendation only
Dimensions shown are nominal in millimeters

Tape and Reel

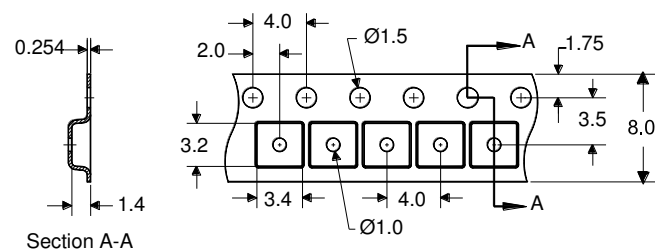
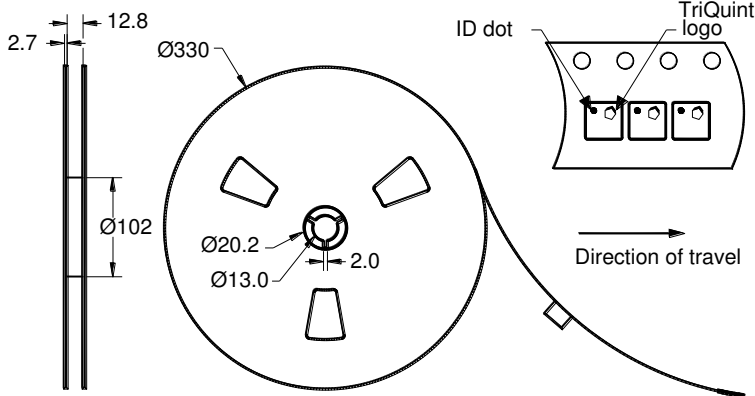

Dimensions shown are nominal in millimeters
Packaging quantity: 5000 units/reel

Maximum Ratings

Parameter	Symbol	Minimum	Maximum	Unit
Operating Temperature Range	T	-30	+85	°C
Storage Temperature Range	T _{stg}	-40	+85	°C
Input Power ⁽¹⁾	P _{in}	-	+22	dBm

Note:

1. Input Power is targeted for an applied CW modulated RF signal at 55 °C for 125 hours

Important Notes

Warnings

- Electrostatic Sensitive Device (ESD) 
- Avoid ultrasonic exposure

RoHS Compliance

- This product complies with EU directive 2002/95/EC (RoHS) 

Solderability

- Compatible with JEDEC J-STD-020C **Pb**-free process, **260 °C** peak reflow temperature

Links to Additional Technical Information

[PCB Layout Tips](#)

[Qualification Flowchart](#)

[Soldering Profile](#)

[S-Parameters](#)

[RoHS Information](#)

[Other Technical Information](#)

TriQuint's liability is limited only to the Surface Acoustic Wave (SAW) component(s) described in this data sheet. TriQuint does not accept any liability for applications, processes, circuits or assemblies, which are implemented using any TriQuint component described in this data sheet.

Contact Information



PO Box 609501
Orlando, FL, 2860-9501
USA

Phone: +1 (407) 886-8860
Fax: +1 (407) 886-7061
Email: info-product@tqs.com
Web: www.triquint.com

Or contact one of our worldwide
Network of [sales offices](#),
[Representatives or distributors](#)