

857143

1176.45 MHz SAW Filter



Applications

- For GPS applications

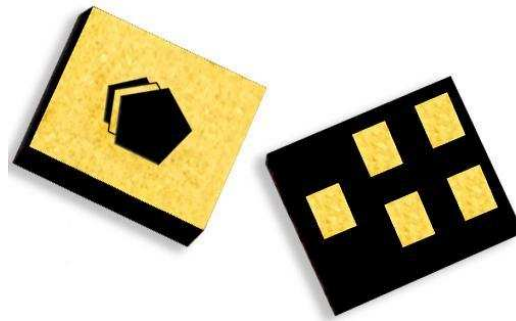

Product Features

- Ultra-Low Loss
- Usable bandwidth 20.46 MHz
- Single-ended operation
- Ceramic chip-scale Package (CSP)
- Small Size: 1.40 x 1.20 x 0.46 mm
- Hermetically Sealed
- **RoHS** compliant, **Pb**-free

General Description

857143 is specifically designed for GPS applications.

857143 uses advanced and inexpensive packaging techniques to achieve an extremely small 1.40 x 1.20 x 0.46 mm hermetically sealed package.

Functional Block Diagram

Top view

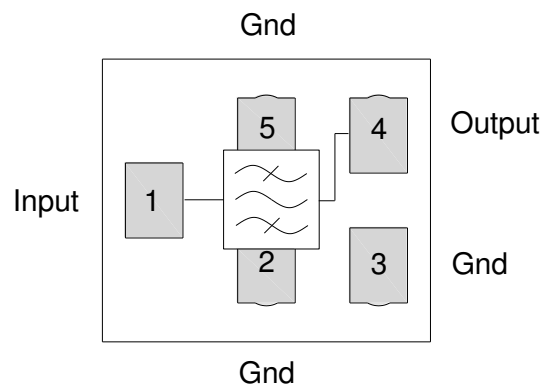

Pin Configuration

Pin #	Balanced	Description
1		Input
4		Output
2,3,5		Ground

Ordering Information

Part No.	Description
857143	packaged part
857143-EVB	evaluation board

Standard T/R size = 10000 units/reel.

Specifications

Electrical Specifications ⁽¹⁾

Specified Temperature Range: ⁽²⁾ -55 to +85 °C

Parameter ⁽³⁾	Conditions	Min	Typical ⁽⁴⁾	Max	Units
Center Frequency		-	1176.45	-	MHz
Maximum Insertion Loss	1175.25 – 1177.65 MHz	-	0.5	0.9	dB
Lower 2.0dB Bandedge		-	1159.33	1166.22	MHz
Upper 2.0dB Bandedge		1186.68	1197.57	-	MHz
Lower 21dB Bandedge		1126.45	1144.55	-	MHz
Upper 21dB Bandedge		-	1208.29	1226.45	MHz
Amplitude Variation	1175.25 – 1177.65 MHz	-	0.03	0.2	dB p-p
Relative Attenuation ⁽⁵⁾	414 – 550 MHz	20	24.0	-	dB
	1100 – 1126.45 MHz	21	24.3	-	dB
	1226.45 – 1250 MHz	21	26.7	-	dB
	1310 – 1770 MHz	20	21.1	-	dB
Input Return Loss	1175.25 – 1177.65 MHz	15	25.8	-	dB
Output Return Loss	1175.25 – 1177.65 MHz	15	27.1	-	dB
Source Impedance (Single-ended) ⁽⁶⁾		-	50	-	Ω
Load Impedance (Single-ended) ⁽⁶⁾		-	50	-	Ω

Notes:

- All specifications are based on the TriQuint schematic for the main reference design shown on page 3
- In production, devices will be tested at room temperature to a guardbanded specification to ensure electrical compliance over temperature
- Electrical margin has been built into the design to account for the variations due to temperature drift and manufacturing tolerances
- Typical values are based on average measurements at room temperature
- Relative to zero dB.
- This is the optimum impedance in order to achieve the performance shown

Absolute Maximum Ratings

Parameter	Rating
Operating Temperature ⁽⁷⁾	-55 to +85 °C
Storage Temperature	-55 to +85 °C
Input Power ⁽⁸⁾	+20 dBm

- Device may operate over this range with degraded Electrical Specifications
- Device is measured for equivalent 10K hours @ +85 °C [CW Signal]

Operation of this device outside the parameter ranges given above may cause permanent damage.

Reference Design

Schematic

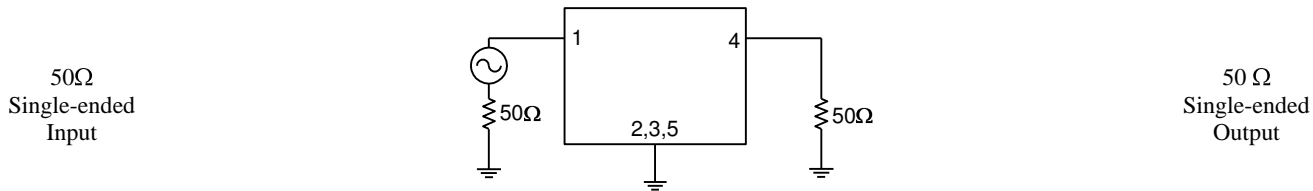

Notes:

1. Actual matching values may vary due to PCB layout and parasitic

PC Board

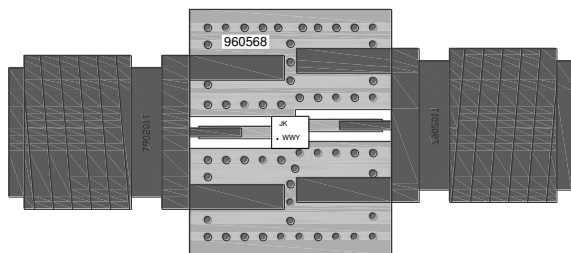

Notes:

- Top, middle & bottom layers: 1 oz copper
- Substrates: FR4 dielectric, .031" thick
- Finish plating: Nickel: 3-8µm thick, Gold: .03-.2µm thick
- Hole plating: Copper min .0008µm thick

Mounting Configuration

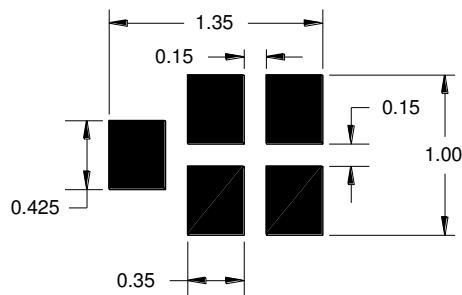

Notes:

1. All dimensions are in millimeters.
2. This footprint represents a recommendation only.

Bill of Material

Reference Desg.	Value	Description	Manufacturer	Part Number
SMA	N/A	SMA connector	Radiall USA Inc.	9602-1111-018
PCB	N/A	3-layer	multiple	960568

Typical Performance (at room temperature)

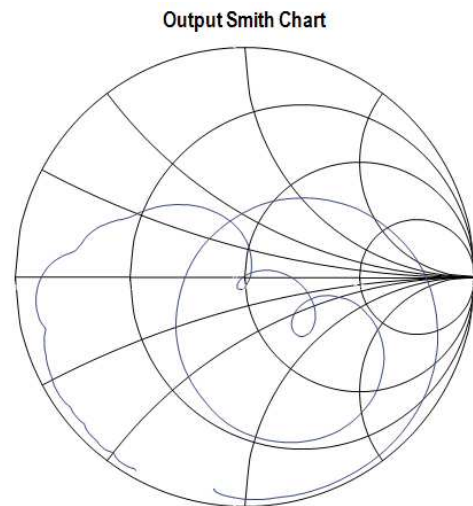
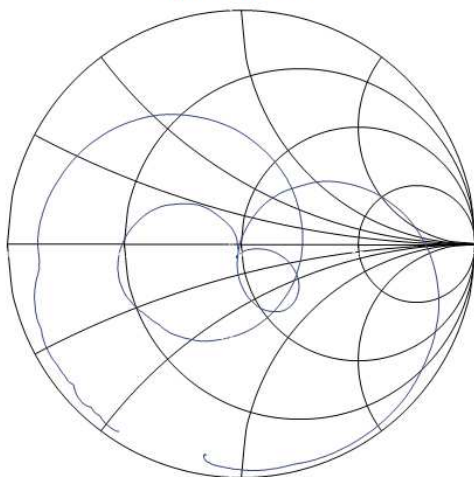
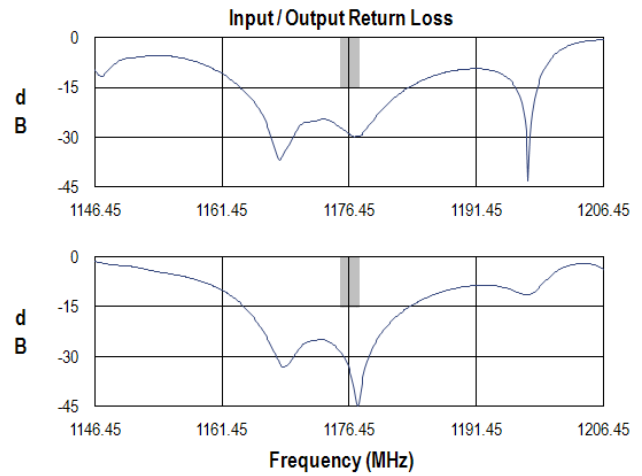
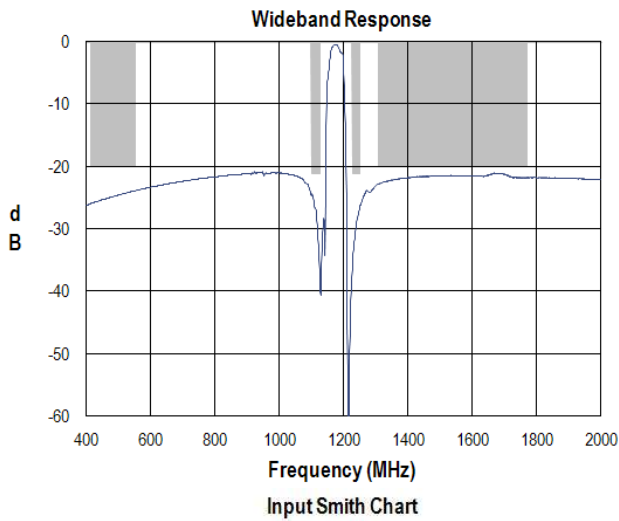
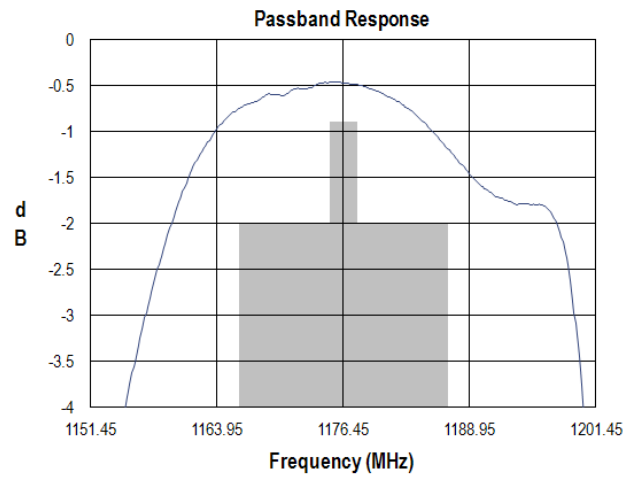
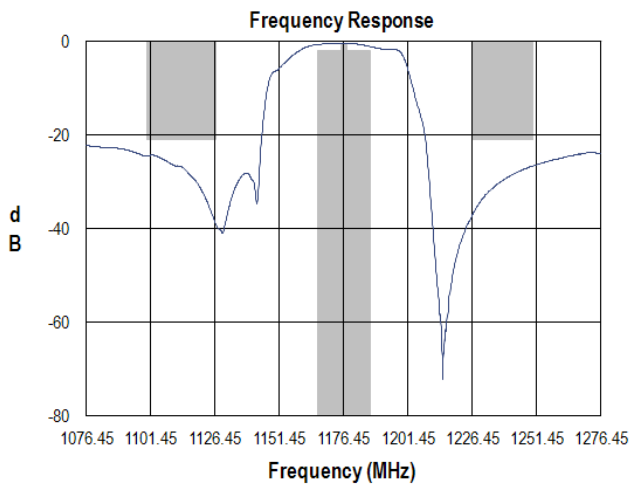

857143

1176.45 MHz SAW Filter

Mechanical Information

Package Information, Dimensions and Marking

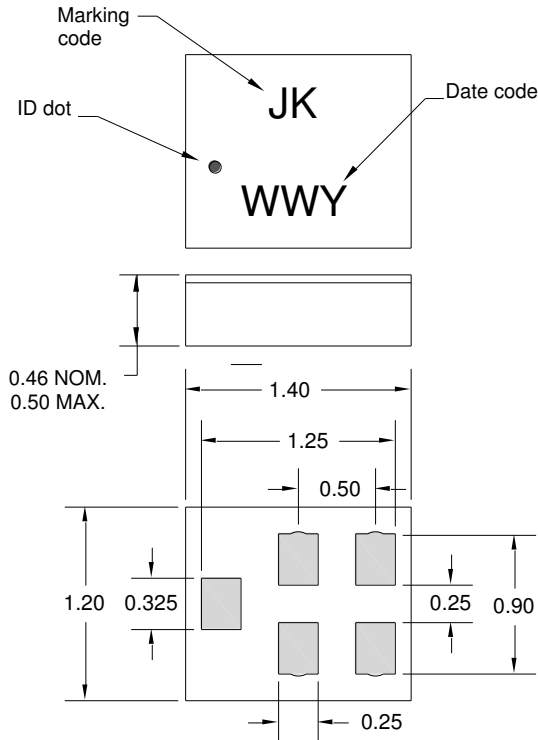

Package Style: CSP-5BT
Dimensions: 1.40 x 1.20 x 0.46 mm

Body: Al₂O₃ ceramic
Lid: Kovar or Alloy 42, Au over Ni plated

Terminations: Au plating 0.5 - 1.0µm, over a 2-6µm Ni plating

All dimensions shown are nominal in millimeters
All tolerances are ±0.15mm except overall length and width ±0.10mm

The date code consists of: WW = 2 digit week and Y = last digit of year

Tape and Reel Information

Standard T/R size = 10000 units/reel. All dimensions are in millimeters

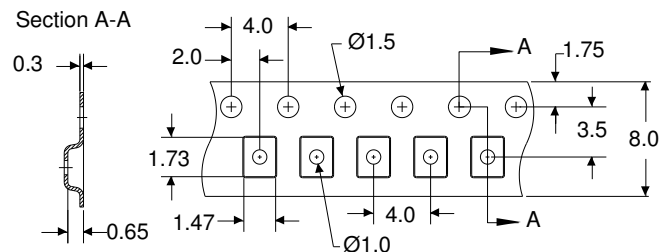
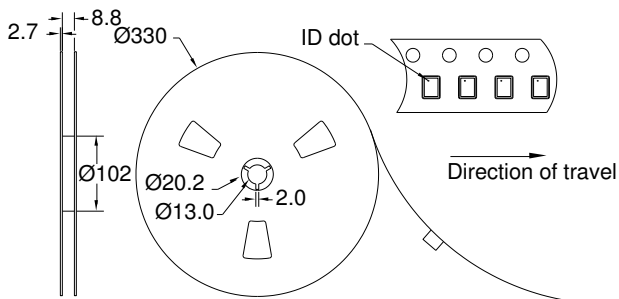

857143

1176.45 MHz SAW Filter

Product Compliance Information

ESD Information



Caution! ESD-Sensitive Device

ESD Rating: TBD

Value: Passes \geq TBD V min.
Test: Human Body Model (HBM)
Standard: JEDEC Standard JESD22-A114

ESD Rating: TBD

Value: Passes \geq TBD V min.
Test: Machine Model (MM)
Standard: JEDEC Standard JESD22-A115

MSL Rating

Devices are Hermetic, therefore MSL is not applicable

Solderability

Compatible with the latest version of J-STD-020, lead free solder, 260°C

Refer to [Soldering Profile](#) for recommended guidelines.

This part is compliant with EU 2002/95/EC RoHS directive (Restrictions on the Use of Certain Hazardous Substances in Electrical and Electronic Equipment).

This product also has the following attributes:

- Halogen Free (Chlorine, Bromine)
- Antimony Free
- TBBP-A (C₁₅H₁₂Br₄O₂) Free
- PFOS Free
- SVHC Free

Contact Information

For the latest specifications, additional product information, worldwide sales and distribution locations, and information about TriQuint:

Web: www.triquint.com Tel: +1.407.886.8860
Email: info-sales@tqs.com Fax: +1.407.886.7061

For technical questions and application information:

Email: flapplication.engineering@tqs.com

Important Notice

The information contained herein is believed to be reliable. TriQuint makes no warranties regarding the information contained herein. TriQuint assumes no responsibility or liability whatsoever for any of the information contained herein. TriQuint assumes no responsibility or liability whatsoever for the use of the information contained herein. The information contained herein is provided "AS IS, WHERE IS" and with all faults, and the entire risk associated with such information is entirely with the user. All information contained herein is subject to change without notice. Customers should obtain and verify the latest relevant information before placing orders for TriQuint products. The information contained herein or any use of such information does not grant, explicitly or implicitly, to any party any patent rights, licenses, or any other intellectual property rights, whether with regard to such information itself or anything described by such information.

TriQuint products are not warranted or authorized for use as critical components in medical, life-saving, or life-sustaining applications, or other applications where a failure would reasonably be expected to cause severe personal injury or death.