

DATA SHEET

AS196-307, AS196-307LF: GaAs IC High-Isolation SPDT Nonreflective Switch with Driver LF-6 GHz

Features

- Positive voltage control (0/3 to 0/5 V)
- High isolation (55 dB @ 0.9 GHz and 1.9 GHz)
- LPCC 4 x 4 mm package
- Integrated silicon CMOS driver
- Nonreflective
- Available lead (Pb)-free and RoHS-compliant MSL-1 @ 260 °C per JEDEC J-STD-020

Description

The AS196-307 is a GaAs FET IC SPDT nonreflective switch packaged in a 16-lead exposed pad plastic package for low-cost, high-isolation commercial applications. Ideal building block for base station applications where synthesizer isolation is critical. Typical applications include GSM, PCS, WCDMA, 2.4 and 5.8 GHz ISM and wireless local loop.

NEW Skyworks offers lead (Pb)-free, RoHS (Restriction of Hazardous Substances)-compliant packaging.



Functional Block Diagram

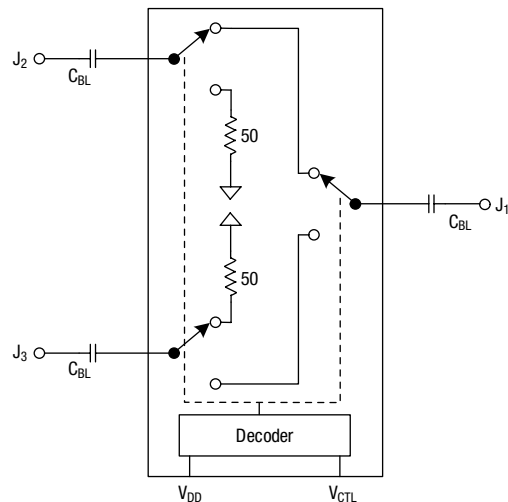

$C_{BL} = 47 \text{ pF}$ for operation > 500 MHz.

Electrical Specifications (0, 5 V) -40 °C to +85 °C

Parameter ⁽¹⁾	Frequency	Min.	Typ.	Max.	Unit
Insertion loss	LF-2 GHz		0.9	1.15	dB
	LF-3 GHz		1.0	1.25	dB
	LF-4 GHz		1.2	1.40	dB
	LF-6 GHz		1.6	2.00	dB
Isolation ⁽²⁾	LF-2 GHz	50	55		dB
	LF-3 GHz	43	50		dB
	LF-4 GHz	35	40		dB
	LF-6 GHz	25	30		dB
VSWR (on state)	LF-2 GHz		1.3:1	1.5:1	
	LF-6 GHz		1.3:1	1.6:1	
VSWR (off state)	0.5-6 GHz		1.35:1	1.7:1	

1. All measurements made in a 50 Ω system, unless otherwise specified.
 2. Backside of exposed pad must be connected to RF ground to obtain specified isolation.

 **Innovation to Go™**
 Now available for purchase online.

Operating Characteristics (0, 5 V) -40 °C to +85 °C

Parameter	Condition	Frequency	Min.	Typ.	Max.	Unit
Switching characteristics ⁽¹⁾						
Rise, fall	10/90% or 90/10% RF			30		ns
On, off	50% CTL to 90/10% Rf			50		ns
Video feedthru	T _{RISE} = 3 ns, BW = 500 MHz			25		mV
Input power for 1 dB compression	V _{CTL} = 0/3 V	0.9–6 GHz	17	21		dBm
	V _{CTL} = 0/5 V	0.9–6 GHz	24	27		dBm
Intermodulation intercept point (IP3)	For two-tone input power +8 dBm					
	V _{CTL} = 0/3 V	0.9–6 GHz	30	38		dBm
	V _{CTL} = 0/5 V	0.9–6 GHz	38	46		dBm
Thermal resistance				25		°C/W
Control voltage	Low ("0")		0		0.5	V
	High ("1")		V _{DD} -0.6		V _{DD}	V
Control current	V _{CTL} = "0" or "1". V _{DD} = 2.6 to 5 V			5		μA
Supply voltage	V _{DD}		2.6	3	5	V
Supply current	V _{DD} = 3 V			10	50	μA
	V _{DD} = 5 V			20	100	μA

1. V_{DD} must be powered on by a minimum of 10 ns prior to V_{CTL}.

Typical Performance Data (0, 5 V)

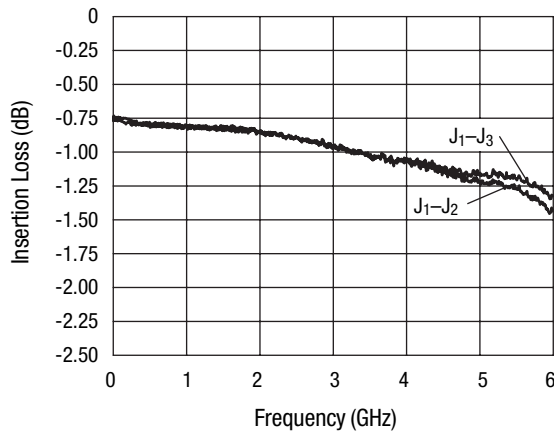

Insertion Loss, 25 °C
V_{DD} = 5 V, V_{CTL} = 0/5 V

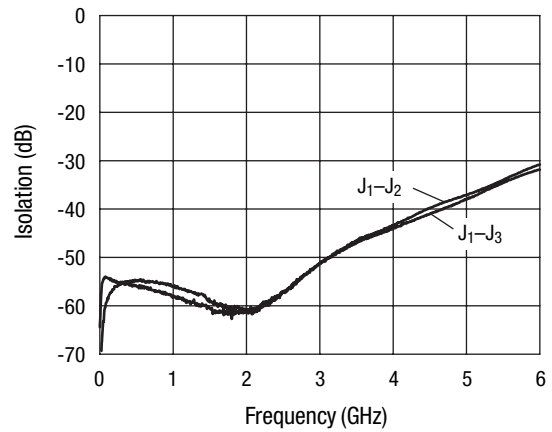

Isolation, 25 °C
V_{DD} = 5 V, V_{CTL} = 0/5 V

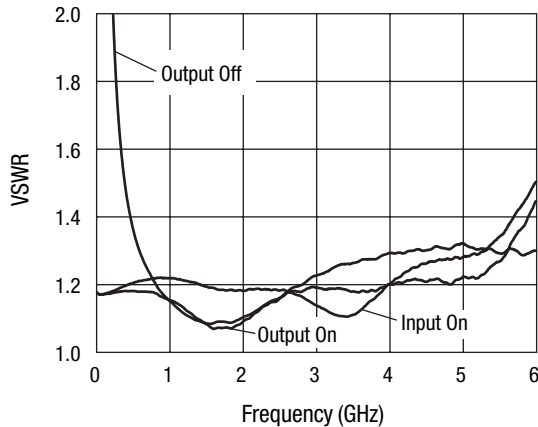

VSWR, 25 °C
V_{DD} = 5 V, V_{CTL} = 0/5 V

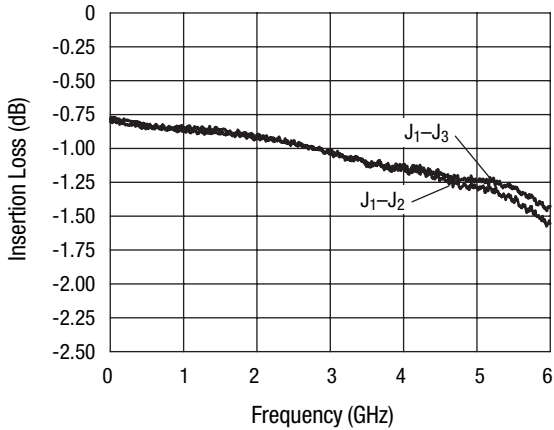

Insertion Loss, 85 °C
 $V_{DD} = 5\text{ V}, V_{CTL} = 0/5\text{ V}$

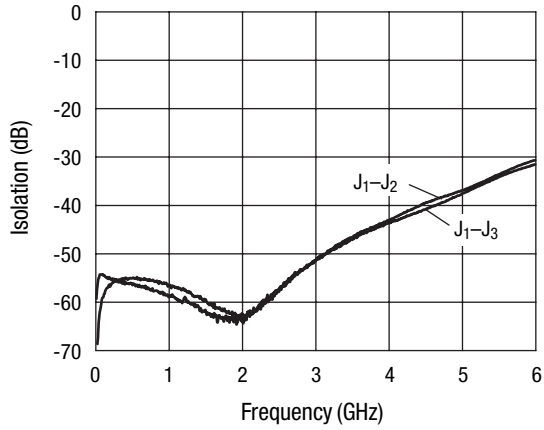

Isolation, 85 °C
 $V_{DD} = 5\text{ V}, V_{CTL} = 0/5\text{ V}$

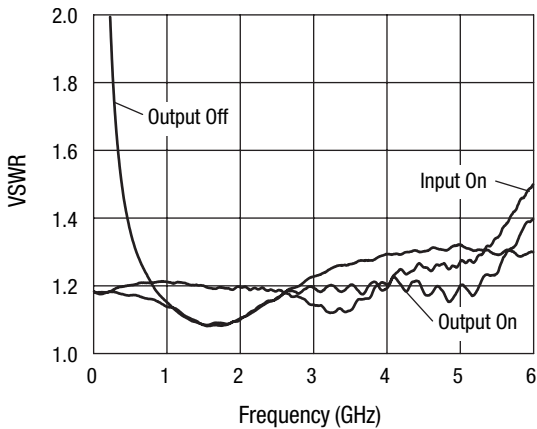

VSWR, 85 °C
 $V_{DD} = 5\text{ V}, V_{CTL} = 0/5\text{ V}$

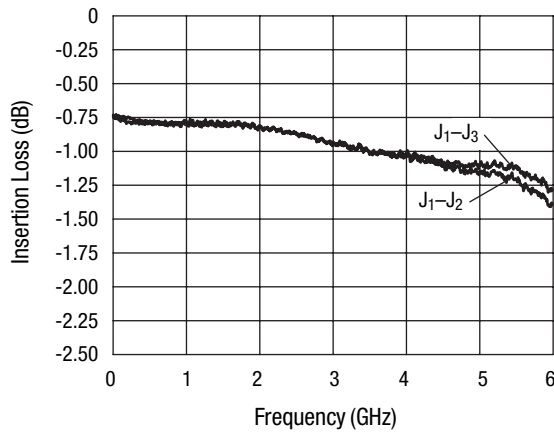

Insertion Loss, -40 °C
 $V_{DD} = 5\text{ V}, V_{CTL} = 0/5\text{ V}$

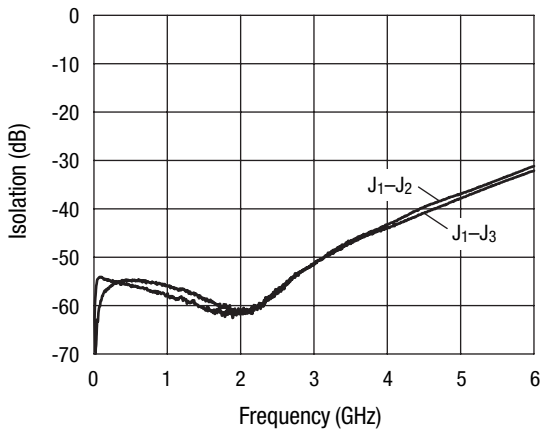

Isolation, -40 °C
 $V_{DD} = 5\text{ V}, V_{CTL} = 0/5\text{ V}$

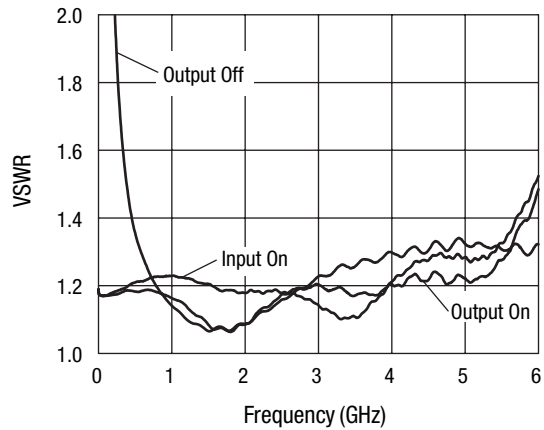

VSWR, -40 °C
 $V_{DD} = 5\text{ V}, V_{CTL} = 0/5\text{ V}$

Compression Point vs. Voltage and Temperature

Control Voltage (V)	Temperature (°C)	Input Power @ 1 dB Compression (dBm)	Input Power @ 0.1 dB Compression (dBm)
3	-40	20.5	16.5
3	25	20	15.3
3	85	19	14
5	-40	28.5	23
5	25	28	23
5	85	27.5	23

Frequency: 500 MHz.

Absolute Maximum Ratings

Characteristic	Value
RF input power	1 W max. > 500 MHz, 0/8 V control
Control voltage	-0.2 V, +8 V
Operating temperature	-40 °C to +85 °C
Storage temperature	-65 °C to +150 °C

Performance is guaranteed only under the conditions listed in the specifications table and is not guaranteed under the full range(s) described by the Absolute Maximum specifications. Exceeding any of the absolute maximum/minimum specifications may result in permanent damage to the device and will void the warranty.

CAUTION: Although this device is designed to be as robust as possible, ESD (Electrostatic Discharge) can damage this device. This device must be protected at all times from ESD. Static charges may easily produce potentials of several kilovolts on the human body or equipment, which can discharge without detection. Industry-standard ESD precautions must be employed at all times.

Recommended Solder Reflow Profiles

Refer to the [“Recommended Solder Reflow Profile”](#) Application Note.

Tape and Reel Information

Refer to the [“Discrete Devices and IC Switch/Attenuators Tape and Reel Package Orientation”](#) Application Note.

IP3 vs. Voltage and Temperature

Control Voltage (V)	Temperature (°C)	IP3 @ 5 dBm Each T one (dBm)
3	-40	45.5
3	25	45
3	85	34
5	-40	45.5
5	25	45.5
5	85	40.5

Two tone input power: 5 dBm each tone.
Tone frequencies: 900 and 901 MHz.

Truth Table

V _{CTL}	J ₁ -J ₂	J ₁ -J ₃
0	Insertion loss	Isolation
1	Isolation	Insertion loss

“0” = 0–0.5 V.
“1” = 3.5–5 V.
V_{DD} = 5 V.

Pin Out (Top View)

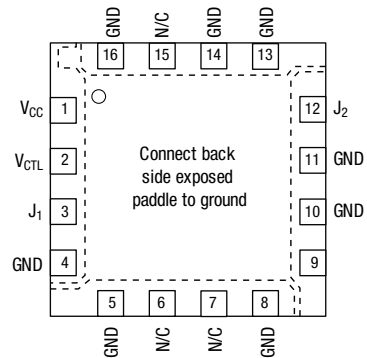

Evaluation PCB

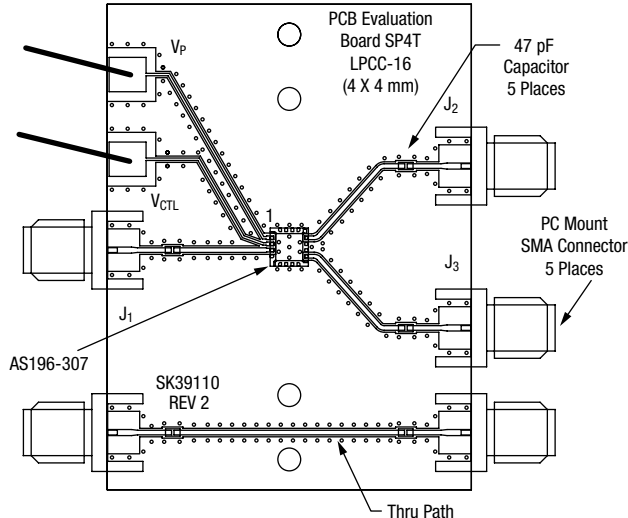

LPCC 4 x 4 (-307)

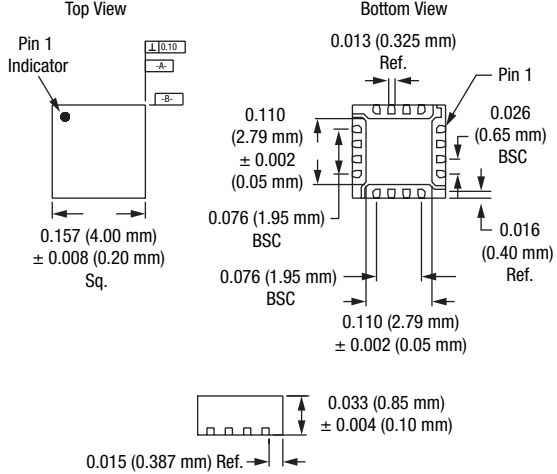

PCB# SK39110. Material: FR4.
 The circuit board used in the final application should employ RF circuit design techniques. RF signal lines should have 50 Ω impedance. The package bottom ground plane should be connected directly to PCB ground plane. A sufficient number of via holes should be used to connect the top and bottom ground planes. The evaluation circuit board shown is available upon request.

Copyright © 2002, 2003, 2004, 2005, 2006, Skyworks Solutions, Inc. All Rights Reserved.

Information in this document is provided in connection with Skyworks Solutions, Inc. ("Skyworks") products or services. These materials, including the information contained herein, are provided by Skyworks as a service to its customers and may be used for informational purposes only by the customer. Skyworks assumes no responsibility for errors or omissions in these materials or the information contained herein. Skyworks may change its documentation, products, services, specifications or product descriptions at any time, without notice. Skyworks makes no commitment to update the materials or information and shall have no responsibility whatsoever for conflicts, incompatibilities, or other difficulties arising from any future changes.

No license, whether express, implied, by estoppel or otherwise, is granted to any intellectual property rights by this document. Skyworks assumes no liability for any materials, products or information provided hereunder, including the sale, distribution, reproduction or use of Skyworks products, information or materials, except as may be provided in Skyworks Terms and Conditions of Sale.

THE MATERIALS, PRODUCTS AND INFORMATION ARE PROVIDED "AS IS" WITHOUT WARRANTY OF ANY KIND, WHETHER EXPRESS, IMPLIED, STATUTORY, OR OTHERWISE, INCLUDING FITNESS FOR A PARTICULAR PURPOSE OR USE, MERCHANTABILITY, PERFORMANCE, QUALITY OR NON-INFRINGEMENT OF ANY INTELLECTUAL PROPERTY RIGHT; ALL SUCH WARRANTIES ARE HEREBY EXPRESSLY DISCLAIMED. SKYWORKS DOES NOT WARRANT THE ACCURACY OR COMPLETENESS OF THE INFORMATION, TEXT, GRAPHICS OR OTHER ITEMS CONTAINED WITHIN THESE MATERIALS. SKYWORKS SHALL NOT BE LIABLE FOR ANY DAMAGES, INCLUDING BUT NOT LIMITED TO ANY SPECIAL, INDIRECT, INCIDENTAL, STATUTORY, OR CONSEQUENTIAL DAMAGES, INCLUDING WITHOUT LIMITATION, LOST REVENUES OR LOST PROFITS THAT MAY RESULT FROM THE USE OF THE MATERIALS OR INFORMATION, WHETHER OR NOT THE RECIPIENT OF MATERIALS HAS BEEN ADVISED OF THE POSSIBILITY OF SUCH DAMAGE.

Skyworks products are not intended for use in medical, lifesaving or life-sustaining applications, or other equipment in which the failure of the Skyworks products could lead to personal injury, death, physical or environmental damage. Skyworks customers using or selling Skyworks products for use in such applications do so at their own risk and agree to fully indemnify Skyworks for any damages resulting from such improper use or sale.

Customers are responsible for their products and applications using Skyworks products, which may deviate from published specifications as a result of design defects, errors, or operation of products outside of published parameters or design specifications. Customers should include design and operating safeguards to minimize these and other risks. Skyworks assumes no liability for applications assistance, customer product design, or damage to any equipment resulting from the use of Skyworks products outside of stated published specifications or parameters.

Skyworks, the Skyworks symbol, "Breakthrough Simplicity" and "Innovation to Go" are trademarks or registered trademarks of Skyworks Solutions, Inc., in the United States and other countries. Third-party brands and names are for identification purposes only, and are the property of their respective owners. Additional information, including relevant terms and conditions, posted at www.skyworksinc.com, are incorporated by reference.